

USER MANUAL

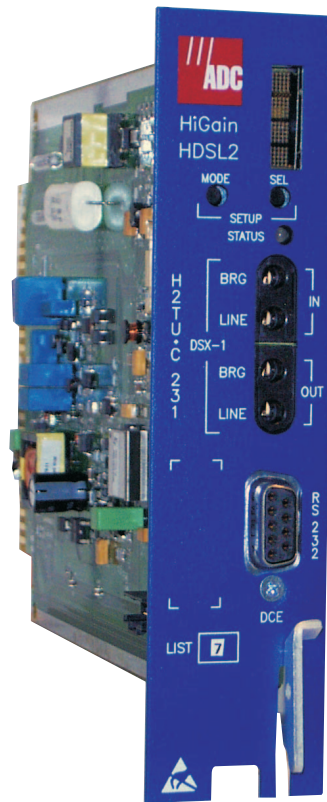

HiGain H2TU-C-231 List 7 Line Unit
Product Catalog: H2TU-C-231-L7
CLEI: VACJDL7E



Revision History of This Manual

To order copies of this document, use document catalog number LTPH-UM-1181-01.

Issue	Release Date	Revisions Made
1	November 15, 2002	Initial release

Copyright

November 15, 2002

© 2002 ADC DSL Systems, Inc. All rights reserved.

Trademark Information

ADC is a registered trademark of ADC Telecommunications, Inc. HiGain is a registered trademark of ADC DSL Systems, Inc. No right, license, or interest to such trademarks is granted hereunder, and you agree that no such right, license, or interest shall be asserted by you with respect to such trademark. Other product names mentioned in this document are used for identification purposes only and may be trademarks or registered trademarks of their respective companies.

Disclaimer of Liability

Information contained in this document is company private to ADC DSL Systems, Inc., and shall not be modified, used, copied, reproduced or disclosed in whole or in part without the written consent of ADC.

Contents herein are current as of the date of publication. ADC reserves the right to change the contents without prior notice. In no event shall ADC be liable for any damages resulting from loss of data, loss of use, or loss of profits, and ADC further disclaims any and all liability for indirect, incidental, special, consequential or other similar damages. This disclaimer of liability applies to all products, publications and services during and after the warranty period.

USING THIS MANUAL

The following conventions are used in this manual:

- Monospace type indicates screen text.
- Keys you press are indicated by small icons such as **Y** or **ENTER**. Key combinations to be pressed simultaneously are indicated with a plus sign as follows: **CTRL** + **ESC**.
- Items you select are in **bold**.
- Three types of messages, identified by icons, appear in text.



Notes contain information about special circumstances.



Cautions indicate the possibility of personal injury or equipment damage.



The Electrostatic Discharge (ESD) symbol indicates that a device or assembly is susceptible to damage from electrostatic discharge.

For a list of abbreviations used in this document, refer to [“Appendix E - Abbreviations”](#) on page 61.

INSPECTING SHIPMENT

Upon receipt of the equipment:

- Unpack each container and inspect the contents for signs of damage. If the equipment has been damaged in transit, immediately report the extent of damage to the transportation company and to ADC DSL Systems, Inc. Order replacement equipment, if necessary.
- Check the packing list to ensure complete and accurate shipment of each listed item. If the shipment is short or irregular, contact ADC DSL Systems, Inc. as described in [“Appendix D - Product Support”](#) on page 60. If you must store the equipment for a prolonged period, store the equipment in its original container.

TABLE OF CONTENTS

Overview	1
Features	1
Applications	2
Front Panel	3
Installation	7
Verification	8
Verification without an H2TU-R Remote Unit	8
Verification with an H2TU-R Remote Unit	8
Provisioning	9
Using the MODE and SEL Pushbuttons	9
Setting Options through MODE and SEL	9
Resetting to Factory Defaults	9
Displaying System Parameter Settings	10
Loopback Modes	10
Using a Maintenance Terminal	10
Connecting to a Maintenance Terminal	10
Logon Screen	11
Provisioning Tasks	13
Setting Date and Time	13
Setting Circuit ID Numbers	14
Configuring the System	15
Clearing the History, Alarm, and Event Log Screens	21
Monitoring System Activity and Performance	23
Using the Monitor Screen to View System Activity	23
Using the Performance Screens to View Performance Data	25
Performance History at the DS1 Interface	25
Performance History at the HDSL2 Interface	29
Using the Performance Screens to View Alarm Data	31
Alarm History at the DS1 Interface	32
Alarm History at the HDSL2 Interface	34
Using the System Event Log to Track Events	35
Event Log Messages	36
Using the Report Menu	37
Testing	39
Front-Panel System Alarms	39
Alarm Option for the Digital Loop Carrier Feed	40

Retiring System Alarms	40
Remote LOS and AIS Response	41
OCT55 Test Pattern with AMI Line Code	41
Loopback Operation	42
Generic Loopback Commands	42
Special Loopback Commands	44
Manual Loopback Session	45
Loopback Test Procedures	46
General Troubleshooting Tips	46
GNLB Test Procedures	46
A1LB, A2LB, and A5LB Test Procedures	48
A3LB and A4LB Test Procedures	50
Testing with H2TU-C BERT Generator	51
Testing with H2TU-R BERT Generator	52
Appendix A - Specifications	53
Power Consumption	54
Maximum Power Dissipation	54
Maximum Current Drain	54
Loop Attenuation	55
Card-Edge Connector	55
Fuse Alarm	56
Craft Port	57
Appendix B - Functional Operation	58
Timing	58
Ground Fault Detection	58
Appendix C - Compatibility	59
Appendix D - Product Support	60
Appendix E - Abbreviations	61
Certification and Warranty	Inside Back Cover

LIST OF FIGURES

1. H2TU-C Front Panel	3
2. Installing the H2TU-C into a Shelf	7
3. Logon Screen.....	11
4. Config Menu - Date and Time	13
5. Inventory Screen.....	14
6. Config Menu.....	15
7. Config Menu - Standard Options (defaults shown).....	16
8. Config Menu - ADC Options (defaults shown)	16
9. Config Menu - Set to Factory Defaults	21
10. Config Menu - Master Clear	22
11. Monitor Screen - Active Loopback with Alarms	23
12. H2TU-R DS1 31-Day Performance History	25
13. H2TU-R DS1 25-Hour Performance History.....	26
14. H2TU-C DS1 48-Hour Performance History.....	26
15. H2TU-R DS1 Current Statistics	27
16. H2TU-C DS1 Current Statistics	27
17. H2TU-C HDSL2 31-Day Performance History	29
18. H2TU-C HDSL2 48-Hour Performance History	29
19. H2TU-C HDSL2 25-Hour Performance History	30
20. H2TU-C HDSL2 Current Statistics.....	30
21. H2TU-C DS1 Alarm History Screen.....	32
22. H2TU-R DS1 Alarm History Screen.....	32
23. H2TU-C HDSL2 Alarm History Screen	34
24. System Event Log	35
25. Report Menu - Full Report	37
26. H2TU-R LOS and AIS Response Priorities	41
27. Loopback Summary	42
28. Loopback Modes	47
29. H2TU-C BERT Generator Screen.....	51
30. H2TU-R BERT Generator Screen.....	52
31. Card-Edge Connector	56
32. RS-232 Craft Port Pinouts	57
33. H2TU-C Block Diagram	58

LIST OF TABLES

1. Front-Panel Descriptions	4
2. Front-Panel Display Messages	5
3. Front-Panel Status LED Functions	8
4. Navigational Keys for the Maintenance Terminal Screens	11
5. Logon Screen Menus	12
6. H2TU-C Standard Config Menu Options.....	17
7. H2TU-C ADC Config Menu Options.....	18
8. DS1 and DSX-1 24-hour PM Threshold	20
9. Monitor Screen Descriptions	24
10. Error Acronyms Used on the DS1 Performance History Screens	28
11. Error Acronyms Used on the HDSL2 Performance History Screens	31
12. DS1 Alarm Descriptions.....	33
13. HDSL2 Alarm Descriptions	34
14. Event Log Messages	36
15. Report Types.....	38
16. Front-Panel System Alarms Summary	39
17. Summary of HiGain HDSL2 Loopback Codes and Activation Methods.....	43
18. Addressable Repeater Loopback Commands (A1LB, A2LB, A5LB).....	48
19. Addressable Repeater Loopback Commands (A3LB and A4LB).....	50
20. BERT Signal Generator Option Settings	51
21. H2TU-C Power Parameters	54
22. HDSL2 Reach Chart	55

OVERVIEW

The H2TU-C-231 List 7 (H2TU-C) is the Central Office (CO) side of a repeaterless T1 transmission system. The system provides 1.544 Mbps transmission on one unconditioned copper pair over the full Carrier Service Area (CSA) range.

The H2TU-C is designed to mount in standard 220 mechanics shelves. For a list of compatible shelves, see [“Appendix C - Compatibility”](#) on page 59.

FEATURES

Standard features include:

- HDSL2 transmission features
 - Lightning and power cross-protection on HDSL2 interfaces
 - Full duplex HDSL2 transmission on one pair at 1.552 Mbps
 - Ultra-low wander (Stratum 1 compliant)
 - Grounded loop and tip and ring reversal detection
 - Sources sealing current when connected to locally powered H2TU-R
- Front-Panel provisioning features
 - Four-character status display
 - DS1 input and output bridging and line access
 - Light Emitting Diode (LED) for system status reporting
 - MODE and SEL system option pushbuttons
 - RS-232 craft port for connection to a maintenance terminal
- HDSL2 maintenance screens for inventory, provisioning, and troubleshooting
 - DS1 and HDSL2 performance monitoring
 - Loop attenuation and insertion loss reporting
 - DS1 and HDSL2 alarm histories
 - Payload (PL) and HDSL Generic (HG) loopback source identification
 - Margin Alarm (MAL) threshold
 - Report menu option for downloading status and performance monitoring data to a file
 - Bit Error Rate Tester (BERT)
- Configuration options
 - Selectable DSX-1 pre-equalizer
 - Bipolar Violation Transparency (BPVT)
 - Bit Error Rate (BER) alarm
 - Loss of Signal/Alarm Indication Signal (LOS/AIS) payload alarm
 - Remote provisioning
 - Selectable loopback activation codes



DS1 is used throughout this document to refer to either the remote unit's DS1 interface or the line unit's DSX-1 interface.

APPLICATIONS

HiGain HDSL2 systems provide a cost-effective, easy-to-deploy method for delivering T1 High Capacity Digital Service (HCDS) over a single copper pair.

- The service is deployed over one unconditioned, non-loaded copper pair.
- Conventional inline DS1 repeaters are no longer required.
- Cable pair conditioning, pair separation and bridged tap removal are not required.

Each loop has no more than 35 dB of insertion loss (INSL) at 196 kHz, with driving and terminating impedances of 135Ω. In general, HiGain HDSL2 systems:

- Operate effectively in the same cable binder group with other HDSL2 lines, HDSL, T1, ADSL, SDSL, POTS, DDS, and other transmission schemes.
- Can be used with customers requiring DS1 service on a temporary or permanent basis.
- Provide a means of quickly deploying service in advance of fiber-optic transmission systems.

FRONT PANEL

Figure 1 shows the H2TU-C front panel. Table 1 on page 4 describes the front-panel components. For pinout diagrams of the H2TU-C card-edge connector and craft port, refer to “Appendix A - Specifications” on page 53.

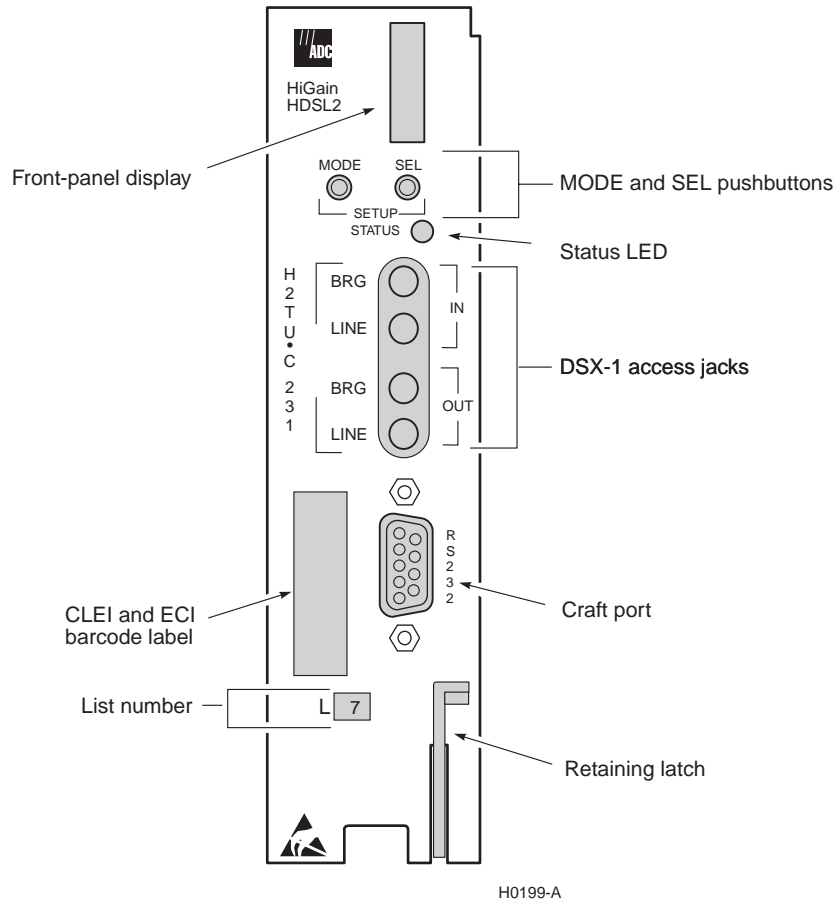

Figure 1. H2TU-C Front Panel

Table 1. Front-Panel Descriptions

Front-Panel Feature	Function
Front-panel display	Displays four-character status, provisioning, and alarm system messages. The front-panel display illuminates when power is initially applied. To conserve power the display only remains on for 5 minutes. Using the MODE or SEL pushbuttons reactivates the display and restarts the 5-minute timer. Refer to Table 2 on page 5 for a listing of the four-character messages.
MODE and SEL pushbuttons	Permits user options to be monitored and modified without the need of a maintenance terminal. Used to initiate all HiGain loopbacks and test states as well as to display DSX-1 line parameters and line unit identity.
Status LED	Reports the conditions described in Table 3 on page 8 .
DSX-1 access jacks	
BRG	Provides non-intrusive bridging jack access to (IN) and from (OUT) the HDSL2 span at the DSX-1 interface.
LINE	Provides splitting jack access to (IN) and from (OUT) the HDSL2 span at the DSX-1 interface. Breaks the IN and OUT paths to permit test signal insertion and retrieval.
Craft port (RS-232)	Provides bidirectional communication between the unit and an external terminal to allow configuration and performance monitoring through the maintenance terminal screens.
CLEI and ECI bar code label	Provides the human-readable Common Language Equipment Identifier (CLEI) code number and the Equipment Catalog Item (ECI) bar code number.
Retaining latch	Retains the H2TU-C when in the upright position and releases the H2TU-C when depressed.
List number	Identifies the list number of the H2TU-C.

Table 2 lists the front-panel display messages. The four-character display reports the code of an alarm, loopback, or diagnostic message and, in some cases, is followed by a second four-character message that modifies the first message with a value or current configuration setting.

Table 2. *Front-Panel Display Messages*

Message	Full Name	Description
ALARM MESSAGES		
ACO	Alarm Cutoff	A system alarm has occurred, and has been retired to an ACO condition by pressing SEL on the H2TU-C front panel.
ALRM	Alarm Condition Exists	Displays prior to any alarm message.
DBER	DS1 Bit Error Rate	A system DS1 BER alarm is in effect and remains until cleared.
HBER	HDSL2 Block Error Rate	A system HDSL2 Block Error Rate alarm is in effect.
LA	Loop Attenuation	Indicates that the attenuation on the HDSL2 loop has exceeded the maximum threshold value.
LAIS	Line Alarm Indication Signal	Indicates an AIS (all ones) pattern is being received or transmitted at the H2TU-C DS1 input or output ports.
LLOS	Line (Unit) Loss of Signal	Indicates that no signal is detected at the DSX-1 input to the H2TU-C. Causes a system alarm.
LOF	Loss of Frame	The DS1 input does not contain the ESF or SF frame-pattern setting of the FRMG option.
LOSW	Loss of Sync Word	Indicates that the HDSL2 loop has lost synchronization.
LRAI	Line RAI	Indicates an RAI alarm (yellow) from the CPE with an error-free signal from the line unit or network.
MAL	Margin Alarm	The margin on HDSL2 loop has dropped below the threshold (0 to 15 dB) as set by the operator.
PWR FEED GND	Power Feed Ground	The HDSL2 loop is grounded.
PWR FEED OPEN	Power Feed Open	Indicates a line power open condition.
PWR FEED SHRT	Power Feed Short	Indicates a short between the Tip and Ring of the HDSL2 pair.
PRMF	Performance Report Messaging - Far End	H2TU-R PRM-FE BER threshold has been exceeded.
PRMN	Performance Report Messaging - Near End	H2TU-R PRM-NE BER threshold has been exceeded.
RAIS	Remote Alarm Indication Signal	Indicates an AIS (all ones) pattern is being received or transmitted at the H2TU-R DS1 input or output ports.
RLOS	Remote (Unit) Loss of Signal	Indicates that no signal is detected at the DS1 input to the H2TU-R. Causes a system alarm.
RRAI	Remote RAI—Remote Alarm Indication at the H2TU-R (Net signal has errors.)	Indicates an RAI alarm (yellow LED) from the CPE with errors from the line unit or network.
TUC	Transmission Unit Central Office	Accompanies the DBER, HBER, LOF, MAL, and LA alarm and indicates that the alarm has occurred at the H2TU-R remote unit.
TUR	Transmission Unit Remote End	Accompanies the DBER, HBER, LOF, MAL, and LA alarm and indicates that the alarm has occurred at the H2TU-R remote unit.
LOOPBACK MESSAGES		
CLOC	Customer Local Loopback	Signal from customer is looped back to customer at the H2TU-R.
COLB	Central Office Loopback	Dual loopback at the H2TU-C.
CREM	Customer Remote Loopback	Signal from customer is looped back to customer at the H2TU-C.
NLOC	Network Local Loopback	DSX-1 signal is looped back to the network at the H2TU-C.
NREM	Network Remote Loopback	DSX-1 signal is looped back to the network at the H2TU-R.
RULB	Remote Unit Loopback	Dual loopback at the H2TU-R.
SMJK	Remote SmartJack Loopback	DSX-1 signal is looped back to the network at the H2TU-R SmartJack module.

Continued

Table 2. Front-Panel Display Messages (Continued)

Message	Full Name	Description
DIAGNOSTIC MESSAGES		
A = xx	Maximum Loop Attenuation	The Attenuation (A) message appears followed by xx, where xx is the highest loop attenuation measured in dB.
ACQ	Acquisition	The multiplexers of the H2TU-C and H2TU-R are trying to establish synchronization over the HDSL2 loop.
ARM	HiGain System Armed	Armed to respond to Intelligent Repeater Loop (ILR) codes.
BAD RT?	No Response from H2TU-R	The H2TU-C receives no response from the H2TU-R and all HDSL2 loop conditions are normal. Therefore, the integrity of the H2TU-R or the HDSL2 loop is questionable.
FERR	Framing Bit Error Occurred	Framing bit error occurred at H2TU-C DSX-1 input.
HES	HDSL2 CRC Error	H2TU-C HDSL2 Loop Cyclical Redundancy Check (CRC) error.
LBPV	Local Bipolar Violation	A bipolar violation has been received at the DSX-1 input to the H2TU-C.
M=xx	HDSL2 Loop Margin	Indicates the power of the received HDSL2 signal relative to noise (S/N with respect to 21.5 dB). Any value of 6 dB or greater is adequate for reliable system operation.
PWR FEED OFF	Power Feed Off	HDSL2 span power has been turned off by setting the PWFD option to off, or HDSL2 span power has been turned off by use of the A1LB, A2LB, or A5LB Intelligent Office Repeater (IOR) Power Down code.
PWR FEED ON	Power Feed On	Indicates that the HDSL2 loop is not grounded or shorted.
SIG	Signaling	The transceivers of the H2TU-C and H2TU-R are trying to establish contact with each other over the HDSL2 loop.
SYSTEM INFORMATION MESSAGES ^(a)		
CODE xxxx	Line Code: AMI or B8ZS	The line code that H2TU-C is receiving at its DSX-1 interface, if the DS1 option is set to AUTO. Otherwise, it mimics either of the other two DS1 line code settings, Alternate Mark Inversion (AMI) or Bipolar with 8-Zero Substitution (B8ZS).
FRM xxxx	Frame: SF, ESF, or UNFR	Defines the type of frame pattern being received from the DSX-1: SuperFrame (SF), Extended SuperFrame (ESF), or Unframed (UNFR).
LATT xx	Loop Attenuation	The current loop attenuation threshold setting measured in decibels.
LIST xx	H2TU-C List Number	The list number of the H2TU-C.
MARG xx	Margin	The current margin threshold setting measured in decibels.
VER x.xx	H2TU-C Software Version Number	The software version number (x.xx).

(a) System information messages are displayed in Scroll Mode. To scroll through the messages, press the MODE pushbutton for 3 or more seconds.

INSTALLATION



When installing an H2TU-C in a chassis, be sure to wear an antistatic wrist strap. Avoid touching components on the circuit board.

Align the H2TU-C with the shelf card-slot guides and slide the unit in. When the H2TU-C is properly seated, the retaining latch snaps closed.



To comply with the intrabuilding wiring requirements of GR-1089 CORE, Section 4.5.9, the shields of the ABAM-type cables that connect the H2TU-C DSX-1 output ports to the cross-connect panel must be grounded at both ends.

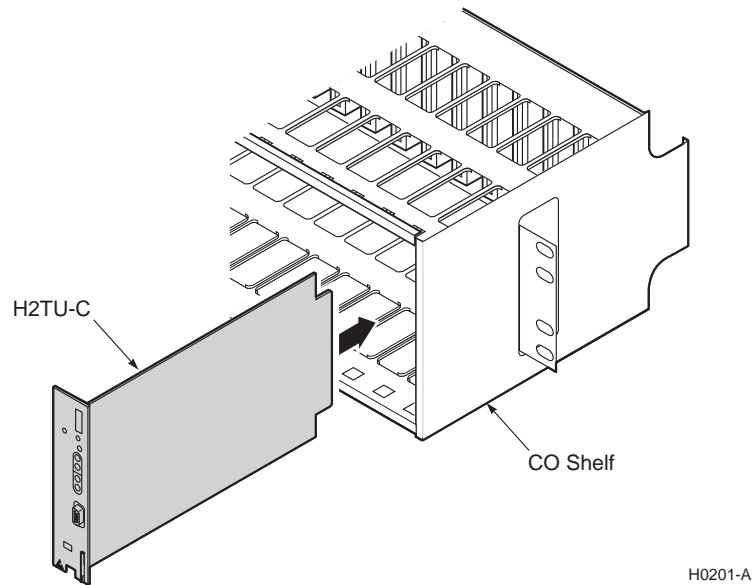

Figure 2. Installing the H2TU-C into a Shelf

VERIFICATION

Once the H2TU-C is installed, verify that it is operating properly. To do this, monitor the following:

- Status LED display (Table 3 below)
- Status messages reported by the front-panel display (Table 2 on page 5 lists the status messages).

Table 3. Front-Panel Status LED Functions

Status LED Display	Description
Off	Line power is off.
Green	Normal operation.
Red	Fuse alarm.
Flashing red	HDSL2 acquisition or system alarm.
Yellow	An H2TU-C Customer Remote Loopback (CREM) or a Network Local Loopback (NLOC) is in effect.
Flashing yellow	H2TU-C is in an Armed state.

Verification without an H2TU-R Remote Unit

If there is no H2TU-R remote unit installed:

- 1 Verify that the H2TU-C powers up. The front-panel display illuminates and reports status messages (Table 2 on page 5 lists the status messages).
- 2 Verify that the H2TU-C attempts to communicate with a remote unit (status LED flashes red). Even if a remote unit is not present, the following events should occur:
 - The front-panel display reports various four-character status messages.
 - The H2TU-C again attempts communication with a remote unit until a remote unit is detected.

Verification with an H2TU-R Remote Unit

If an H2TU-R remote unit has been installed:

- 1 Verify that the H2TU-C powers up. (The front-panel display illuminates and reports various status messages.)
- 2 Verify that the H2TU-C attempts to communicate with the remote unit (status LED flashes red). One of the following occurs:
 - If the remote unit is successfully identified and the HDSL2 loop synchronizes, the H2TU-C status LED lights a steady green. The H2TU-C reports normal margin messages on the front-panel display.
 - If the remote unit is not identified, the H2TU-C reports four-character status messages. The H2TU-C attempts communication again and reports four-character status messages. The H2TU-C repeats this cycle until a remote unit is detected.
- 3 Verify that a valid DS1 signal has been applied to the H2TU-C and the H2TU-R.
 - If no DS1 signal is being applied to either the H2TU-C or the H2TU-R inputs, then the appropriate DS1 alarms (LLOS or RLOS) display on the front panel and the status LED flashes red.
 - If a valid DS1 signal is being supplied to the H2TU-C and H2TU-R, then DS1 alarm indications should be absent and the status LED should be a steady green.

PROVISIONING

There are two provisioning methods:

- Use the MODE and SEL pushbuttons on the front panel of the H2TU-C to:
 - Set system options
 - Reset the H2TU-C to its factory default settings for system options
 - Display system option settings (scroll mode)
 - Select system loopbacks
- Use a maintenance terminal (ASCII terminal or a PC running terminal emulation software) connected to the H2TU-C craft port (or to an HMU craft port) to access the status, history, inventory, and provisioning screens (see [Figure 3 on page 11](#)).



No dip switches or jumpers are required to provision the H2TU-C as it contains a non-volatile RAM (NVRAM) which stores the system option settings. System option settings are retained if shelf power is lost or if the H2TU-C is unplugged.

USING THE MODE AND SEL PUSHBUTTONS

Setting Options through MODE and SEL

To provision the H2TU-C through the MODE and SEL pushbuttons on the front panel:

- 1 Press the MODE pushbutton for 1 second and then release it. The front-panel display alternately shows the first system parameter and its current setting.
- 2 Press the SEL pushbutton to step through all possible settings of the selected parameter.
- 3 After the desired setting has been selected, press the MODE pushbutton. This updates the currently displayed parameter to the selected setting, then advances to the next configurable parameter. After the last parameter has been selected, a CONF NO message appears on the front-panel display.
- 4 Do one of the following:
 - To cancel the session without saving the requested parameter changes, press the MODE pushbutton or do nothing. After 30 seconds, the display returns to its normal mode without saving the new changes.
 - To accept the requested parameter changes, press the SEL pushbutton. A CONF YES message displays, and the display returns to its normal mode after saving the new changes.

Resetting to Factory Defaults

All user options for the H2TU-C, described in [Table 6 on page 17](#), can be set to the factory default values using the MODE and SEL pushbuttons. To set the user options to their default values:

- 1 Press the SEL pushbutton for 6 seconds until the following message appears:
DFLT NO
- 2 Press the SEL pushbutton until the DFLT NO message appears.

The message changes to DFLT YES indicating the factory default values are now in effect, and then the display returns to the normal mode.

To terminate the DFLT mode without setting the factory default values, do one of the following:

- Press the MODE pushbutton to return to the normal display mode.
- Wait 30 seconds for the unit to return to the normal display mode.

Displaying System Parameter Settings

To scroll through the current settings of all system parameters, press the MODE pushbutton for 3 or more seconds. The H2TU-C displays the following parameters:

- Software version number
- List number
- Type of frame pattern received from the DSX-1
- Line code of the signal received from the DSX-1
- All user-configured parameter settings
- Loop attenuation threshold setting
- Margin alarm threshold setting

Loopback Modes

See “[Loopback Operation](#)” on page 42 for instructions on using the MODE and SEL pushbuttons to activate loopbacks.

USING A MAINTENANCE TERMINAL

Connecting to a Maintenance Terminal

The craft port on the front panel allows you to connect the H2TU-C to a maintenance terminal (ASCII terminal or PC running a terminal emulation program). Once connected to a maintenance terminal, you can access the maintenance, provisioning, and performance screens.

To connect to a maintenance terminal:

- 1 Connect a standard 9-pin terminal cable to the RS-232 craft port, as shown in [Figure 1 on page 3](#), on the front panel.
- 2 Connect the other end of the cable to the serial port on the maintenance terminal.
- 3 Use a VT100 or PC running terminal emulation software to access the maintenance terminal.
- 4 Configure the maintenance terminal to the following communication settings:
 - 9600 baud
 - No parity
 - 8 data bits

- 1 stop bit
 - Hardware flow control to OFF
- 5 If necessary, press **CTRL** + **R** to refresh the logon screen.

Logon Screen

The maintenance terminal screens allow you to monitor, provision, and troubleshoot an HDSL2 system.

To select a menu from the logon screen (Figure 3), use the **←** **→** arrow keys, then press **ENTER**.

Table 4 summarizes the navigational keys. They are also listed in the onscreen Help menu. Table 5 on page 12 describes the Logon screen menus.

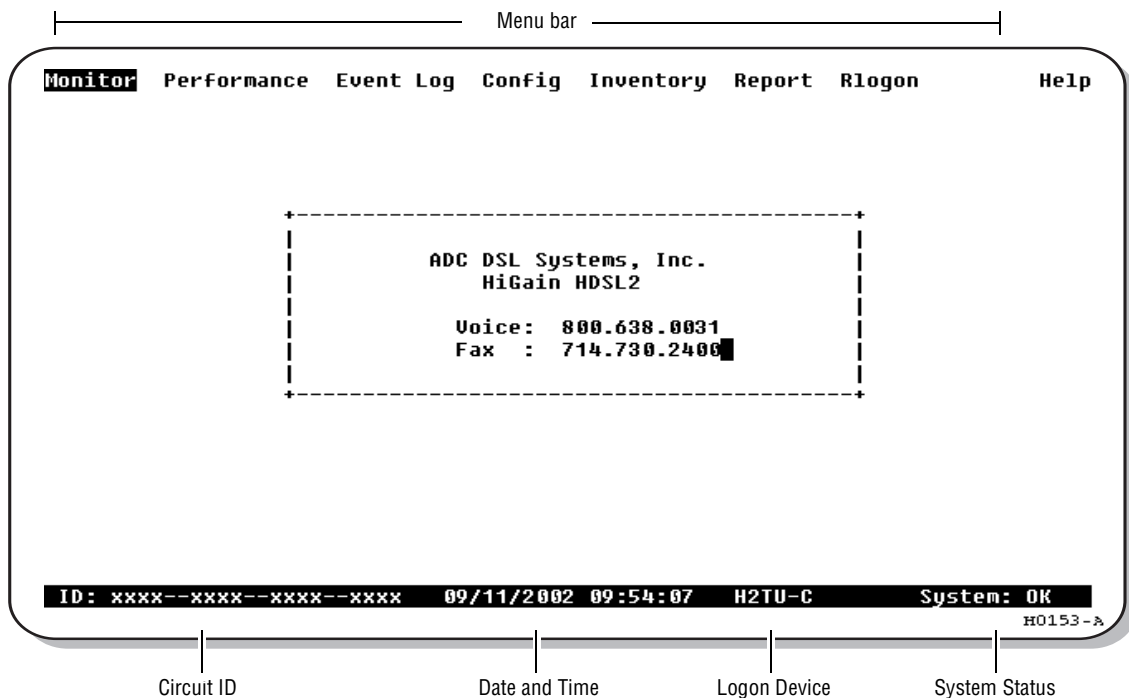

Figure 3. Logon Screen

Table 4. Navigational Keys for the Maintenance Terminal Screens

Key ^(a)	Function
SPACEBAR	Cycle through selections.
ENTER	Activate the current setting or choice, or display a menu.
ESC or F11 (VT100 only)	Return to the parent menu.
↑ or CTRL + E	Select the submenu or item above the current one, or return to the previous menu.
↓ or CTRL + X	Select the submenu or item below the current one.
→ or CTRL + D	Select the menu or item to the right of the current one.
← or CTRL + S	Select the menu or item to the left of the current one, or return to the previous menu.
CTRL + R	Refresh the screen.

(a) Legacy management units require the use of control keys instead of arrow keys.



Most VT100 emulation programs support a print screen option. For Windows-based programs, such as Procomm or HyperTerminal, see the Help menu for instructions.

Table 5. Logon Screen Menus

Press this key:	To access this menu:	Menu Functions
M	Monitor	Monitors loopbacks and alarms and provides a graphical representation of circuit activity, including ES, UAS, SES, and line code.
P	Performance	Provides performance and alarm histories for current, 25-hour, 48-hour, or 31-day periods for either the DS1 or HDSL2 interface.
E	Event Log	Identifies the 100 most recent system events and reports the date and time of occurrence.
C	Config	Provides standard configuration options, ADC options, date and time setting, and a reset option (factory settings). Also provides a master clear option that clears all performance, alarm, and event log entries.
I	Inventory	Provides product information about the various devices that are in the system and lists circuit and device identifications.
O	Report	Provides four types of reports: Full Report, Short Report, System Information Report, and Event Report.
R	Rlogon/Rlogout	Remote logon can be performed from the H2TU-C or H2TU-R. The screen displays Rlogout when the H2TU-C or H2TU-R is remotely logged on to the other unit at the end of the circuit. To log off from the remote unit, press R . Rlogout changes to Rlogon. The unit is now locally logged on until R is pressed again to reinitiate the remote logon.
H	Help	Provides a glossary of terms used in the maintenance screens, a list of navigational keys, print guide, and ADC contact information.

PROVISIONING TASKS

After the H2TU-C is successfully installed, perform these basic provisioning tasks:

- Set date and time (see “Setting Date and Time” on this page).
- Set circuit ID numbers (see “Setting Circuit ID Numbers” on page 14).
- Make any configuration changes (see “Configuring the System” on page 15).
- Clear history, alarm, and event log screens to remove miscellaneous data acquired during startup (see “Clearing the History, Alarm, and Event Log Screens” on page 21).

Setting Date and Time

- 1 Press **C** to select the Config menu.
- 2 Use the **↑** and **↓** arrow keys to select **Date and Time**, then press **ENTER**.
- 3 Type the date in the format indicated (see Figure 4), then press **ENTER**.
- 4 Type the time in the format indicated (entering seconds is optional), then press **ENTER**.

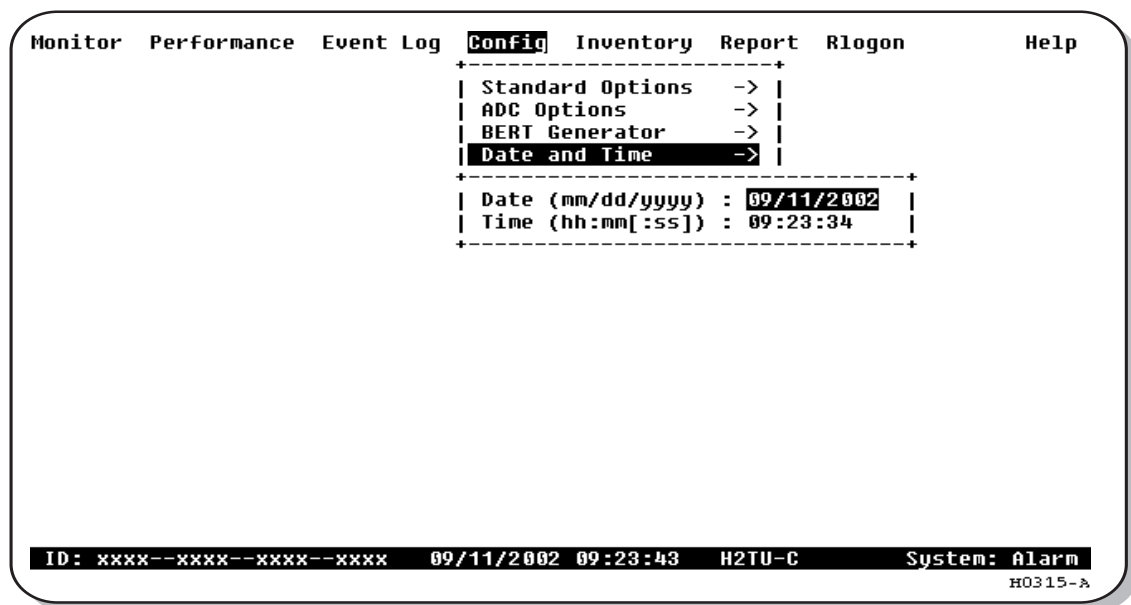

Figure 4. Config Menu - Date and Time

Setting Circuit ID Numbers

The Inventory screen provides product information on all units in the system and allows setting of the circuit and unit identification numbers.

- 1 Press **I** to select the Inventory menu.
- 2 Type the Circuit ID number in the field indicated (see Figure 5), then press **ENTER**.
- 3 Type the ID numbers of all other devices listed in the system, pressing **ENTER** after each entry.
- 4 Type any relevant circuit notes, and then press **ENTER**.

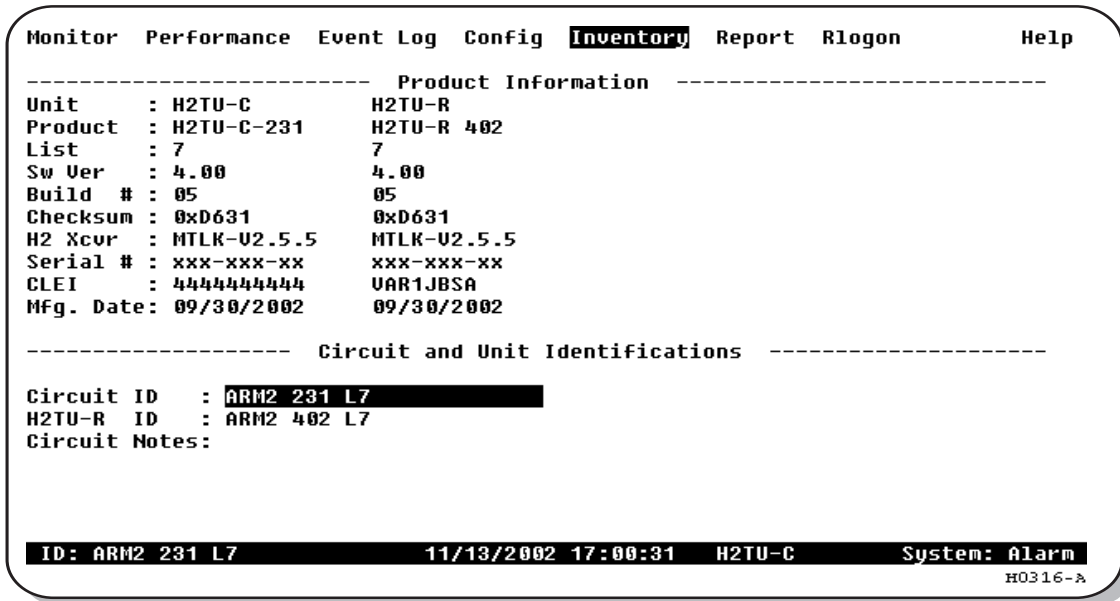

Figure 5. Inventory Screen

Configuring the System

The Config menu (Figure 6 on this page) allows you to make the following changes:

- Standard options (see “Making Changes to Standard and ADC Options” on this page).
- ADC options (see “Making Changes to Standard and ADC Options” on this page).
- Date and time (see “Setting Date and Time” on page 13).
- Master clear (see “Clearing the History, Alarm, and Event Log Screens” on page 21).
- Reset to factory default configuration (see “Resetting the H2TU-C” on page 21).
- BERT Generator (see “Testing with H2TU-C BERT Generator” on page 51 and “Testing with H2TU-R BERT Generator” on page 52).

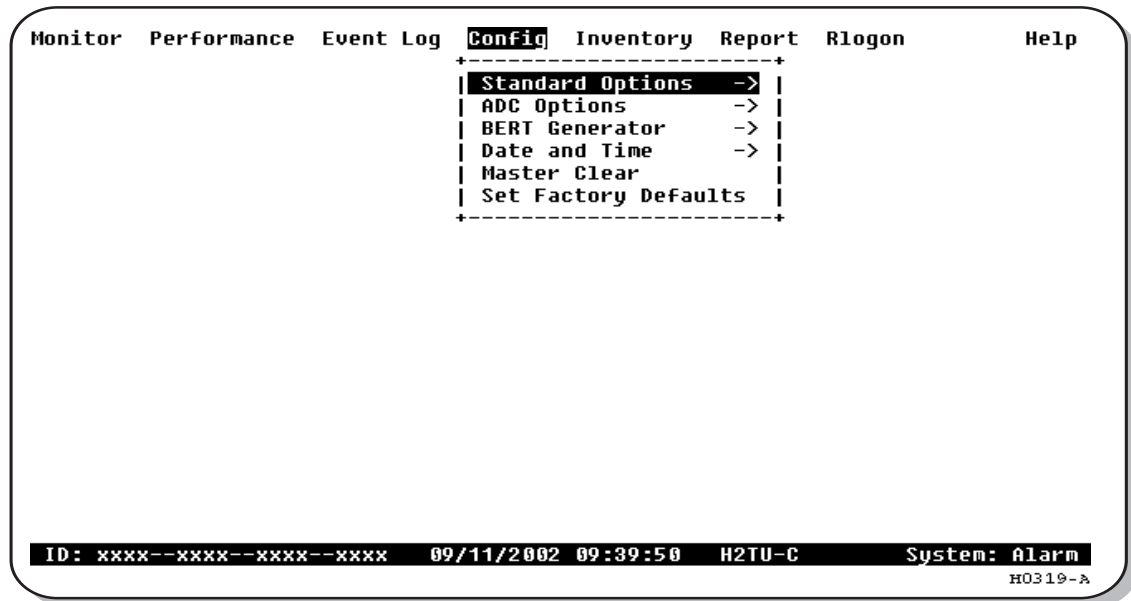

Figure 6. Config Menu

Making Changes to Standard and ADC Options

Figure 7 and Figure 8 on page 16 show the Standard and ADC configuration options. Standard options are those supported by HiGain HDLSL2 units when connected to units from other vendors. ADC options are an extended set of options that are only available when using HiGain units exclusively.

Table 6 on page 17 and Table 7 on page 18 describe the Config menu options and the available settings for each option. The settings in bold type are the factory default settings.

To make changes to these options:

- 1 Press **C** to select the Config menu.
- 2 Use the **↑** and **↓** arrow keys to select **Standard Options** or **ADC Options**, then press **ENTER**.
- 3 Use the arrow keys to select an option.
- 4 Press the **SPACEBAR** to cycle through the available settings for that option.
- 5 Press **ENTER** to activate your choice.

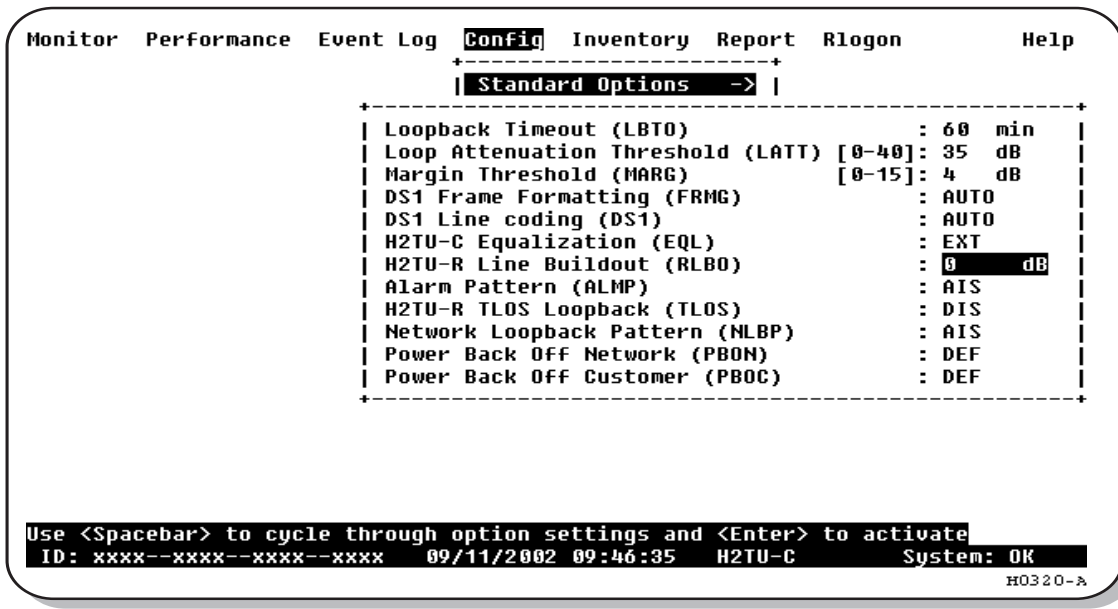

Figure 7. Config Menu - Standard Options (defaults shown)

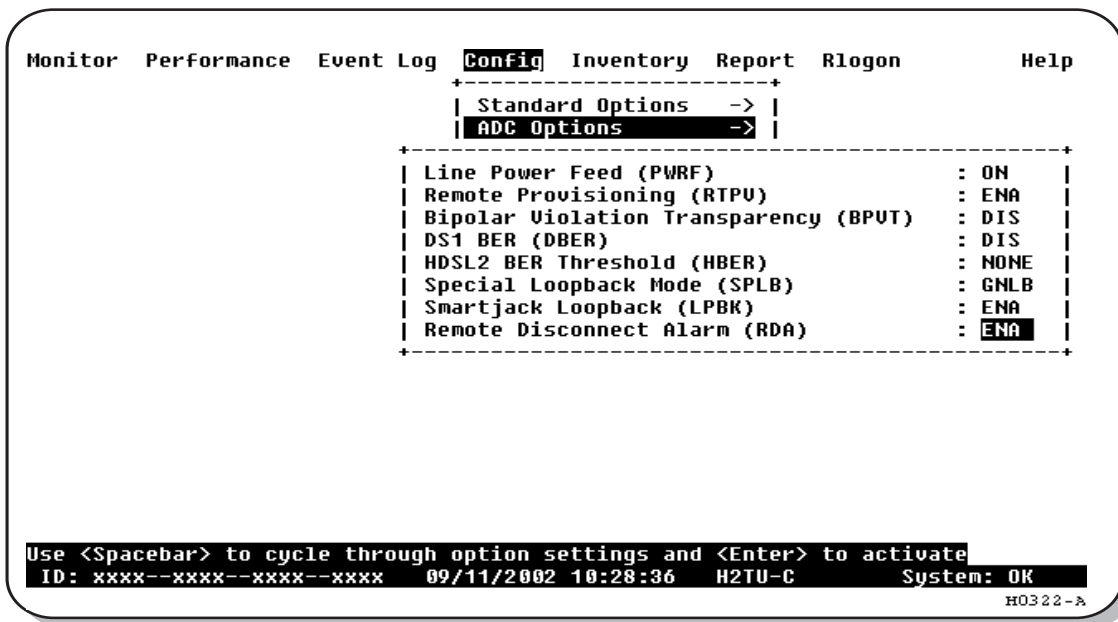

Figure 8. Config Menu - ADC Options (defaults shown)

Table 6. H2TU-C Standard Config Menu Options

Standard Config Menu Options	Front-Panel Display Code	Selection	Description
Loopback Timeout	LBTO	NONE	Disables automatic time-out cancellation of all loopbacks.
		20 min	Sets automatic cancellation of all loopbacks to 20 minutes after initiation.
		60 min	Sets automatic cancellation of all loopbacks to 60 minutes after initiation.
		120 min	Sets automatic cancellation of all loopbacks to 120 minutes after initiation.
		8 hr	Sets automatic cancellation of all loopbacks to 8 hours after initiation.
		24 hr	Sets automatic cancellation of all loopbacks to 24 hours after initiation.
Loop Attenuation Threshold	LATT	0 through 40 dB	Determines the maximum loop attenuation before an alarm is declared. Zero disables the alarm. The loop attenuation threshold can only be set through the maintenance screens.
		35 dB	Default value. Zero disables the alarm.
Margin Threshold	MARG	0 to 15 dB	Determines the minimum allowable margin below which a system alarm can occur. Zero disables the alarm. The Margin Alarm Threshold can only be set through the maintenance screens.
		4 dB	Default value.
DS1 Frame Formatting	FRMG	AUTO	Configures the HDSL2 system to operate in an auto-framing (AUTO) mode in which it continuously searches the input DS1 bit stream for a valid SF or ESF frame pattern. Both line and path performance parameters are maintained. Unframed payloads will cause the ES-P and SES-P counters to increment.
		SF	Configures the HiGain HDSL2 system to search for the SF framing pattern at its DS1 input.
		ESF	Configures the HiGain HDSL2 system to search for the ESF framing pattern at its DS1 input.
		UNFR	Configures the HDSL2 system to operate in an unframed mode. This mode disables the auto framing process and forces the system to function as a transparent bit pipe. Only line parameters are considered when monitoring DS1 performance.
DS1 Line Coding See "DS1 Line Coding (DS1) Option" on page 19.	DS1	AUTO	The H2TU-C and H2TU-R monitor the incoming DS1 bit streams for the B8ZS code. If the H2TU-R detects this code, the H2TU-C enters B8ZS output mode. The H2TU-C reverts back to AMI output mode if no B8ZS codes are received at the H2TU-R input for 5 seconds. Similarly, when the H2TU-C detects the B8ZS code, the H2TU-R enters the B8ZS mode and returns to AMI mode if no B8ZS code is received at the H2TU-C input for 5 seconds.
		B8ZS	Places both the H2TU-C and H2TU-R into their B8ZS modes.
		AMI	Places both the H2TU-C and H2TU-R into their AMI modes.
H2TU-C Equalization See "HDSL2 Equalization (EQL) Option." on page 19	EQL	EXT	Disables the H2TU-C internal equalizer, allowing connection of external equalizer hardware.
		0	Sets the Equalizer to DSX-1 for 0 to 132 feet.
		133	Sets the Equalizer to DSX-1 for 133 to 265 feet.
		266	Sets the Equalizer to DSX-1 for 266 to 398 feet.
		399	Sets the Equalizer to DSX-1 for 399 to 532 feet.
		533	Sets the Equalizer to DSX-1 for 533 to 655 feet.
H2TU-R Line Buildout	RLBO	0 dB	Sets the DS1 RLBO level toward the Customer Interface (CI).
		-7.5 dB	Sets the DS1 RLBO level toward the CI to -7.5 dB.
		-15 dB	Sets the DS1 RLBO level toward the CI to -15 dB.

Continued

Table 6. H2TU-C Standard Config Menu Options (Continued)

Standard Config Menu Options	Front-Panel Display Code	Selection	Description
Alarm Pattern	ALMP	AIS	Enables the HiGain HDSL2 system to output an AIS payload at its DS1 ports for LOSW and LOS DS1. For priority resolution, see Figure 23 on page 34 for LOS/AIS response priorities.
		LOS	Enables the HiGain HDSL2 system to output an LOS condition at its DS1 ports for LOSW and LOS DS1.
H2TU-R TLOS Loopback	TLOS	ENA	Enables a logic loopback at the H2TU-R when an LOS occurs at its DS1 input, if enabled at the H2TU-R. For priority resolution, see Figure 23 on page 34 .
		DIS	Disables TLOS logic loopback.
Network Loopback Pattern	NLBP	AIS	Enables the H2TU-R to transmit an AIS towards CI for any network loopback. For priority resolution, see Figure 23 on page 34 .
		LOS	Enables the H2TU-R to transmit LOS toward the CI for any network loopback.
Power Back Off - Network See “Power Back Off (PBON and PBOC) Options” on page 19.	PBON	DEF	Configures power output levels of the H2TU-C network unit toward customer to comply with the Default template per Section 6.1.4.2 of ANSI T1.418.
		ENH	Configures power output levels of the H2TU-C network unit toward customer to comply with the Enhanced template per Section 6.1.4.2 of ANSI T1.418.
Power Back Off - Customer See “Power Back Off (PBON and PBOC) Options” on page 19.	PBOC	DEF	Configures power output levels of the H2TU-R customer unit toward network to comply with the Default template per Section 6.1.4.2 of ANSI T1.418.
		ENH	Configures power output levels of the H2TU-R customer unit toward network to comply with the Enhanced template per Section 6.1.4.2 of ANSI T1.418.

Table 7. H2TU-C ADC Config Menu Options

ADC Config Menu Options	Front-Panel Display Code	Selection	Description
Line Power Feed	PWRF	OFF	Disables powering to the HDSL2 pair.
		ON	Keeps the HDSL2 line voltage at nominal -185 Vdc.
Remote Provisioning	RTPV	ENA	Enables remote provisioning.
		DIS	Disables remote provisioning.
Bipolar Violation Transparency See “Bipolar Violation Transparency (BPVT) Option” on page 20.	BPVT	ENA	Enables BPVs and HDSL2 CRC errors at the DS1 input to be converted into DS1 BPVs at the DS1 output at the distant end. This makes HiGain HDSL2 transparent to BPVs.
		DIS	Disables BPV Transparency.
DS1 BER Threshold See “DS1 BER (DBER) Option” on page 20.	DBER	ENA	Enables the fixed 24-hour DS1 BER threshold.
		DIS	Prevents the generation of a system alarm due to DS1 BER.
HDSL2 BER Threshold See “HDSL2 BER Threshold (HBER) Option” on page 20	HBER	1E-6	System alarm relay contact closes and the Status LED flashes red when the Block Error Rate (BER) exceeds 10 ⁻⁶ .
		1E-7	System alarm relay contact closes and the Status LED flashes red when BER exceeds 10 ⁻⁷ .
		NONE	Prevents generation of a system alarm due to BER.

Continued

Table 7. H2TU-C ADC Config Menu Options (Continued)

ADC Config Menu Options	Front-Panel Display Code	Selection	Description
Special Loopback Mode	SPLB	GNLB	Configures the HiGain HDSL2 system to respond to the generic in-band loopback codes.
		A1LB and A2LB	Configures the HiGain HDSL2 system to respond to the in-band loopback codes of the Westell addressable repeater.
		A3LB	Configures the HiGain HDSL2 system to respond to the in-band loopback codes of the Wescom addressable repeater.
		A4LB	Configures the HiGain HDSL2 system to respond to the in-band loopback codes of the Wescom Mod 1 addressable repeater.
		A5LB	Configures the HiGain HDSL2 system to respond to the in-band loopback codes of the Westell Mod 1 addressable repeater.
SmartJack Loopback	LPBK	ENA	Enables the HiGain HDSL2 system to recognize all in-band SmartJack loopback commands.
		DIS	Configures the HiGain HDSL2 system to ignore all in-band SmartJack loopback commands.
Remote Disconnect Alarm	RDA	ENA	Enables a remote DS1 LOS condition at the input to the H2TU-R to generate an LOS alarm. AIS or LOS (depending on ALMP) is sent towards the network.
		DIS	Prevents a remote DS1 LOS condition at the input to the H2TU-R from causing an LOS alarm. The alarm relay contacts do not close and LOS is sent toward the network from the H2TU-C instead of AIS.

DS1 Line Coding (DS1) Option. The DS1 line code option should always be set to conform to the type of DS1 service (AMI or B8ZS) being provided by the HiGain system. The Auto mode, which can adapt to either AMI or B8ZS, should only be used in applications that require it (such as when HiGain acts as a standby circuit to DS1 circuits whose line codes are not known or may be both AMI and B8ZS). This is because the Auto mode induces one BPV in the DS1 bit stream whenever it switches from AMI to B8ZS. The Auto mode allows both the H2TU-C and the H2TU-R to set its DS1 output code to that which is being received at the distant end DS1 input. This forces the input and the output codes in each direction of transmission to be identical.

HDSL2 Equalization (EQL) Option. The equalizer shapes the DS1 output signal of the H2TU-C to conform to a very specific pulse template when it arrives at the DSX-1 cross-connect point. The degree of pulse-shaping required is a function of the distance between the H2TU-C equipment bay and the DSX-1 panel. Thus, the equalizer has six discrete settings, in increments of 133 feet to cause the maximized separation of 655 feet.

Alarm Pattern (ALMP) Option. To improve HiGain HDSL2 compatibility with the switch-to-protect features used in Digital Loop Carrier (DLC) feeder applications, the H2TU-C has an Alarm Pattern (ALMP) option that allows you to select either an AIS or LOS DS1 output payload for the following alarms:

- LOSW on any loop
- LOS DS1

Power Back Off (PBON and PBOC) Options. Power Back Off Network (PBON) and Power Back Off Customer (PBOC) allow the HDSL2 circuit to support two transmit power templates: default (DEF), higher level, and enhanced (ENH), lower level. These are defined in the four-wire section of the ANSI T1.418 Issue 2 HDSL2 standard. Each HDSL4 receiver detects the level it is receiving during the start-up, pre-activation sequence. It then compares this level to the level it should be receiving according to the PBON and PBOC option settings (DEF or ENH). If the received level is outside the template limits, the receiver sends a message to the upstream HDSL2 transmitter requesting the proper level. These levels are adjusted only during the start-up routine or if the PBON or PBOC option settings are changed during normal operation. Since the ENH template levels are up to 15 dBm below those of the DEF template, the ENH setting can be used to reduce crosstalk levels into adjacent circuits. (For example, if crosstalk noise is being induced by the H2TU-R, set the PBOC option to its lower (ENH) level

setting. Conversely, if the HDSL2 signal at the H2TU-R is being affected by crosstalk noise induced from adjacent pairs, set the PBOC option to its higher (DEF) level setting.



Changing these Power Back Off option settings on a live circuit causes the HDSL2 loop to momentarily drop and then reacquire synchronization. This setting can also affect the operating margins.

Bipolar Violation Transparency (BPVT) Option. The H2TU-C improves compatibility with Digital Loop Carrier (DLC) feeder applications because of its ability to transmit DS1 BPV occurrences between its DS1 interfaces. This feature is required to support protection switching in DLC applications. Each DLC terminal must be able to monitor the integrity of its Receive DS1 payload and then switch to the protect line when the integrity of the path drops below specific user selected limits. An essential requirement of this feature is the need for each DLC terminal to detect BPVs in its DS1 input. Standard HDSL systems correct DS1 BPVs at the input and therefore prevent them from being detected by the DLC terminals to which they are connected. The H2TU-C and its associated remote units remove this limitation and become BPV transparent by detecting and counting input BPVs at each end and then by replicating them at the DS1 output port of the distant end.

The BPV count is converted into BPVs at the distant end during the following second at a rate of 1 BPV every 128 DS1 bits up to a maximum of 12000 ($BER = 7.7 \times 10^{-3}$). This maximum rate is more than adequate since it exceeds the maximum 10^{-3} BER required by most DLC systems.

DS1 BER (DBER) Option. The DS1 BER alarm occurs when any of the DS1 or DSX-1 performance monitoring parameters listed in [Table 8](#) exceed the counts shown for the 24-hour period between 12:00:00 AM through 11:59:59 PM. These thresholds correspond to a 10^{-6} BER. All PM counters clear to zero at 12:00:00 AM or when Master Clear is selected. See “[Clearing the History, Alarm, and Event Log Screens](#)” on page 21.

Table 8. DS1 and DSX-1 24-hour PM Threshold

Parameter	Threshold Count
CV-L (BPV)	133,400
CV-P (CRC)	132,960
CV-P (FE in SF)	691
ES-L, ES-P, PRM-NE, PRM-FE	648
SES-L, SES-P	100
UAS-P, UAS-L	10

HDSL2 BER Threshold (HBER) Option. The HBER option permits the monitoring of loop integrity and reporting of alarms when excessive errors are detected. The PM primitive used for this purpose is the CRC checksum performed on the HDSL2 frame for both directions of transmission. It is, therefore, called a block error rate rather than the bit error rate associated with the DS1 interface. The CRC errors and counts are displayed on the monitor screen for both the H2TU-C and H2TU-R. The HBER option allows an alarm to be generated if the total number of CRCs at either the H2TU-C or H2TU-R exceeds the selected BER threshold during the last 1-minute interval.

- HBER option = 1E-6. Alarm is generated if CRC > 93
- HBER option = 1E-7. Alarm is generated if CRC > 9

Once initiated, the HBER count clears when the CRC count drops below the selected threshold. Selecting NONE inhibits this alarm.

Resetting the H2TU-C



Resetting the H2TU-C to its original factory settings may cause interruption of service.

To reset the H2TU-C to its original factory defaults:

- 1 Press **C** to select the Config menu.
- 2 Use the **↑** and **↓** arrow keys to select **Set Factory Defaults**, then press **ENTER**.
- 3 Press **Y** if you want to reset the H2TU-C, or press **N** to cancel this action.

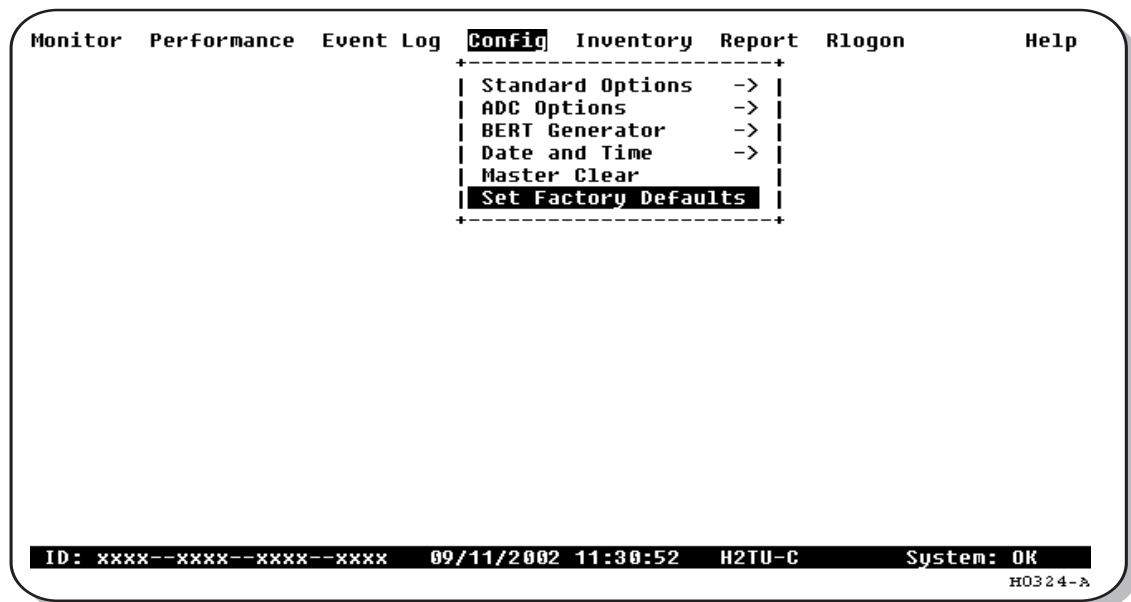

Figure 9. Config Menu - Set to Factory Defaults

Clearing the History, Alarm, and Event Log Screens

Select Master Clear to clear the History, Alarm and Event Log screens after the system has been installed and is functioning properly. This removes miscellaneous data acquired during the startup session and ensures that you have meaningful data thereafter.

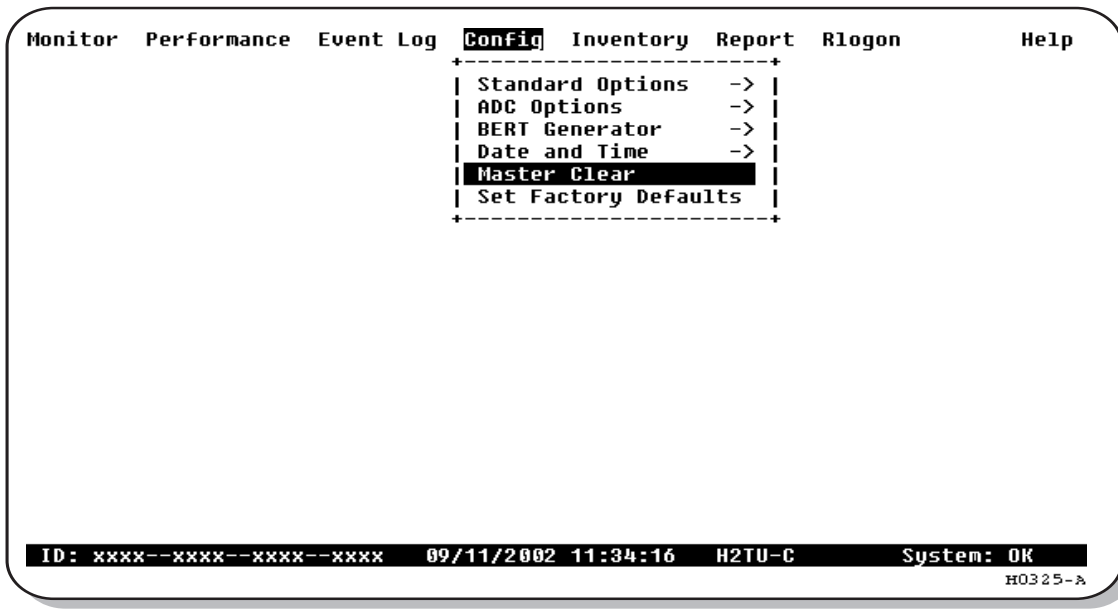

Figure 10. Config Menu - Master Clear

To clear the Event Log, press **E** to select the Event Log screen, then press **L** to clear the screen.

To clear an individual history or alarm screen, do the following:

- 1 Press **P** to select the Performance screen.
- 2 Press the **SPACEBAR** to select an interface (**H2TU-C DS1**, **H2TU-R DS1**, **H2TU-C HDSL2**, or **H2TU-R HDSL2**), then press **ENTER**.
- 3 Press the **SPACEBAR** to select the type of statistics (**Current**, **Alarm History**, **25-Hour History**, **48-Hour History**, or **31-Day History**), press **ENTER** after your selection.
 - Selecting **31 Day History** allows you to clear the current, 25-hour, 48-hour, and 31-day performance history screens for the selected interface.
 - Selecting **Alarm History** allows you to clear the alarm history screen for the selected interface. For information about the DS1 and HDSL2 alarm screens, see [Table 10 on page 28](#) and [Table 11 on page 31](#), respectively.
- 4 Press **L** to clear the screen.
- 5 Press **Y** to confirm.

To clear all history, alarm, and event log screens:

- 1 Press **C** to select the Config screen.
- 2 Use the **↑** and **↓** arrow keys to select **Master Clear**.
- 3 Press **ENTER** to activate.
- 4 Press **Y** to clear all screens.

MONITORING SYSTEM ACTIVITY AND PERFORMANCE

The H2TU-C provides the following maintenance screens for monitoring system activity and assessing performance:

- The Monitor screens provide a graphical representation of circuit activity and allow initiation of loopbacks.
- The Performance screens provide current, 25-hour, 48-hour, and 31-day performance histories and a continuous alarm history.
- The Event Log provides a description of the 100 most recent events. These descriptions include the origin, time and date of occurrence, and a brief message describing the event.

USING THE MONITOR SCREEN TO VIEW SYSTEM ACTIVITY

- 1 Press **M** to view the system diagram.

Figure 11 shows an armed circuit with an active loopback and alarms. Terms used on the system diagram are defined in the onscreen Help menu glossary. Abnormal situations are highlighted on the diagram. Table 9 on page 24 describes the screen field.

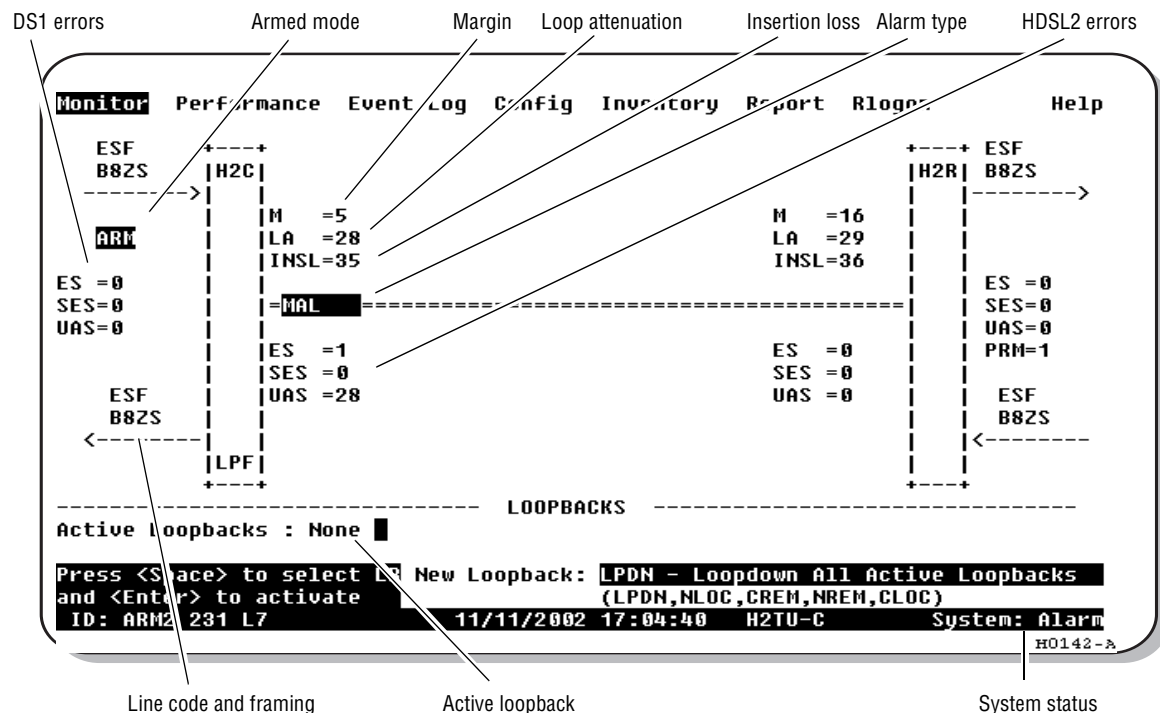

Figure 11. Monitor Screen - Active Loopback with Alarms

- 2 To initiate a loopback, press the **SPACEBAR** to cycle through the loopback choices. Press **ENTER** to select your choice.

When prompted with the message: Are you sure (Y/N)?, press **Y** to initiate the loopback or **N** to cancel. For more information about loopbacks and troubleshooting, see "Testing" on page 39.

- 3 To initiate a loopdown of all active loopbacks, press the **SPACEBAR** to select **LPDN**, then press **ENTER**. When prompted with the message: Are you sure (Y/N)?, press **Y** to initiate the loopdown or **N** to [Table 17 on page 43](#) cancel.

Table 9. Monitor Screen Descriptions

Field	Description
Active loopback	An active loopback is indicated on the lower third of the Monitor screen. Available loopbacks are indicated by gray text. See Table 17 on page 43 for a summary of the HDSL2 generic loopback codes and activation methods.
Alarm type	Indicates type of alarm.
Armed mode	Indicates system is in an armed state for an intelligent repeater (IR) loopback command.
BERT status	Provides BERT Generator status, elapsed time, and BERT results.
Code type	Type of DS1 line coding received or sent (B8ZS or AMI).
DS1 ES count	Errored Seconds—The sum of the Errored Seconds-Line (ES-L) and Errored Seconds-Path (ES-P) counts detected on the DS1 input over a 24-hour period. Errors include DS1 frame errors, BPV, and ESF CRC errors.
DS1 SES count	Severely Errored Seconds—The sum of the DS1 Severely Errored Seconds-Line (SES-L) and Severely Errored Seconds-Path (SES-P) counts over the last 24 hours.
DS1 UAS count	Unavailable Seconds—The number of seconds during which the DS1 input signal was absent over a 24-hour period.
Frame type	Type of DS1 framing detected at the input stream (SF, ESF, or UNFR).
HDSL2 ES count	Errored Seconds—The number of 1-second intervals that contained at least one CRC or LOSW error. This value is a running total of the last 24 Hours.
HDSL2 SES count	Severely Errored Seconds—The number of 1-second intervals that contain at least 50 CRC errors or one or more LOSW defects. An LOSW defect occurs when at least three consecutive HDSL frames contain one or more frame bit errors. This value is a running total of the last 24-hours.
HDSL2 UAS count	Unavailable Seconds—The number of seconds the HDSL2 loop is unavailable. This occurs after 10 contiguous HDSL SES and is retired after 10 contiguous non-SES seconds. This value is a running total of the last 24 hours.
HG or (PL)	HG displays when the loopback was initiated from a HDSL2 Generic (HG) front panel or by a maintenance terminal loopback command. PL displays when the loopback was initiated by a command embedded in the DS1 data path payload (PL).
ID	Circuit identification number.
INSL	Insertion Loss—The signal loss value for a 196 kHz signal over the cable.
LA	Loop Attenuation—Indicates the attenuation of the Overlapped Pulse Amplitude Modulation Transmission with Interlocking Spectra (OPTIS) pulse from the distant end. The value should not exceed 28 dB.
LPF	Line Power Feed—Indicates the HDSL2 line power is on.
M	Margin—The signal-to-noise ratio at all HDSL2 ports, relative to a 10^{-7} Bit Error Rate.
MAL	Margin Alarm—Indicates the margin on HDSL2 loop has dropped below the threshold (0 to 15 dB) set by the operator.
PRM	The sum of the Performance Report Messaging - Near End (PRM-NE) and Performance Report Messaging - Far End (PRM-FE) counts.
System Status	The presence or absence of an alarm condition is indicated on the lower right corner of all screens. System: OK indicates that there are no alarms present; System: Alarm indicates the presence of an alarm. Refer to “Using the Performance Screens to View Alarm Data” on page 31 .

USING THE PERFORMANCE SCREENS TO VIEW PERFORMANCE DATA

The Performance screens display:

- CRC statistics for the HDSL2 or DS1 interface in 31-day, 48-hour, 25-hour, and current history reports.
- Alarm statistics for the DS1 interfaces (Figure 21 on page 32 and Figure 22 on page 32) or DS1 interfaces (Figure 22 on page 32) on a continuous basis.

To access the performance history screens:

- 1 Press **P** to select the Performance screen.
- 2 Press the **SPACEBAR** to select an interface (**H2TU-C DS1**, **H2TU-R DS1**, **H2TU-C HDSL2**, or **H2TU-R HDSL2**), then press **ENTER**.
- 3 Press the **SPACEBAR** to select the type of statistics (**Current**, **Alarm History**, **25-Hour History**, **48-Hour History**, or **31-Day History**), then press **ENTER**.

Performance History at the DS1 Interface

The Performance History for the DS1 interface provides 31-day, 48-hour, 25-hour, and current statistics screens for the H2TU-C and the H2TU-R (as viewed from the H2TU-C).

Figure 12 on this page and Figure 13 on page 26 are examples of DS1 performance history screens at the remote unit. Figure 14 on page 26 is an example of DS1 performance history screens at the line unit. Refer to Table 10 on page 28 for descriptions of the kinds of errors reported on DS1 interface screens. Asterisks indicate performance monitoring from the previous day.

Figure 15 and Figure 16 on page 27 show statistics for the DS1 interface at the remote unit and the line unit, respectively. These screens report 1-day, 1-hour, and 15-minute statistics.

Monitor	Performance	Event Log	Config	Inventory	Report	Rlogon	Help			
H2TU-R DS1 31 Day History (Page 1 of 3)										
Date	CU-L	ES-L	SES-L	UAS-L	CU-P	ES-P	SES-P	UAS-P	PRM-NE	PRM-FE
08/10	-	-	-	-	-	-	-	-	-	-
08/11	-	-	-	-	-	-	-	-	-	-
08/12	-	-	-	-	-	-	-	-	-	-
08/13	-	-	-	-	-	-	-	-	-	-
08/14	-	-	-	-	-	-	-	-	-	-
08/15	-	-	-	-	-	-	-	-	-	-
08/16	-	-	-	-	-	-	-	-	-	-
08/17	-	-	-	-	-	-	-	-	-	-
08/18	-	-	-	-	-	-	-	-	-	-
08/19	-	-	-	-	-	-	-	-	-	-
08/20	-	-	-	-	-	-	-	-	-	-
08/21	-	-	-	-	-	-	-	-	-	-
Press: (N)ext Page, (P)revious Page, C(1)ear History										
Use <Space> to cycle through choices and <Enter> to view				Interface : H2TU-R DS1						
				Statistics : 31-Day History						
ID: xxxx--xxxx--xxxx--xxxx				09/09/2002 15:28:45		H2TU-C		System: OK		
H0143-A										

Figure 12. H2TU-R DS1 31-Day Performance History

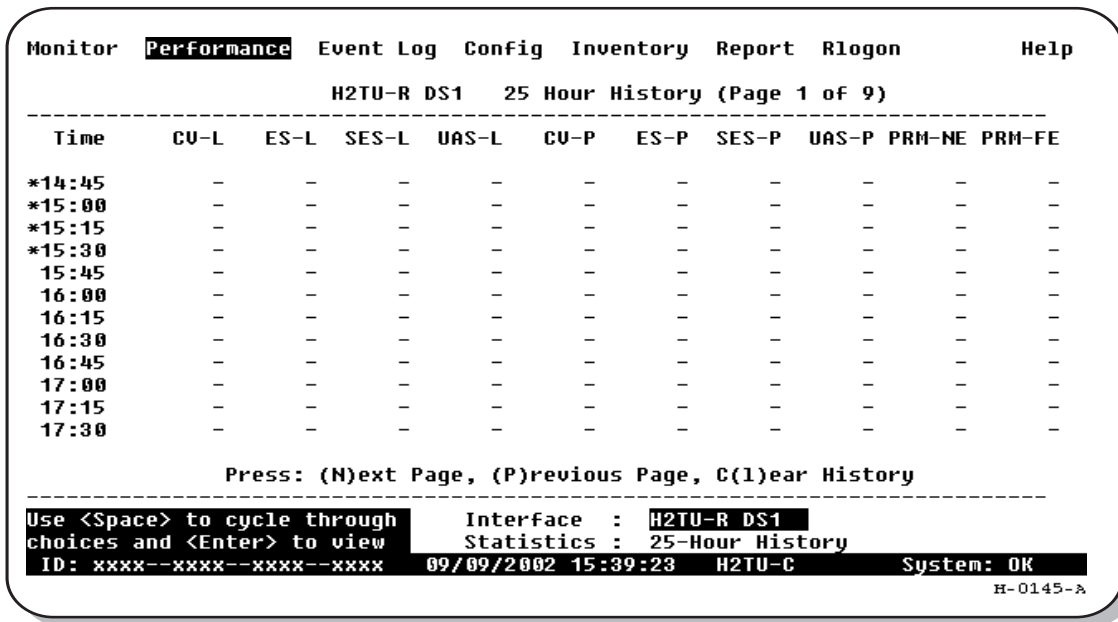

Figure 13. H2TU-R DS1 25-Hour Performance History

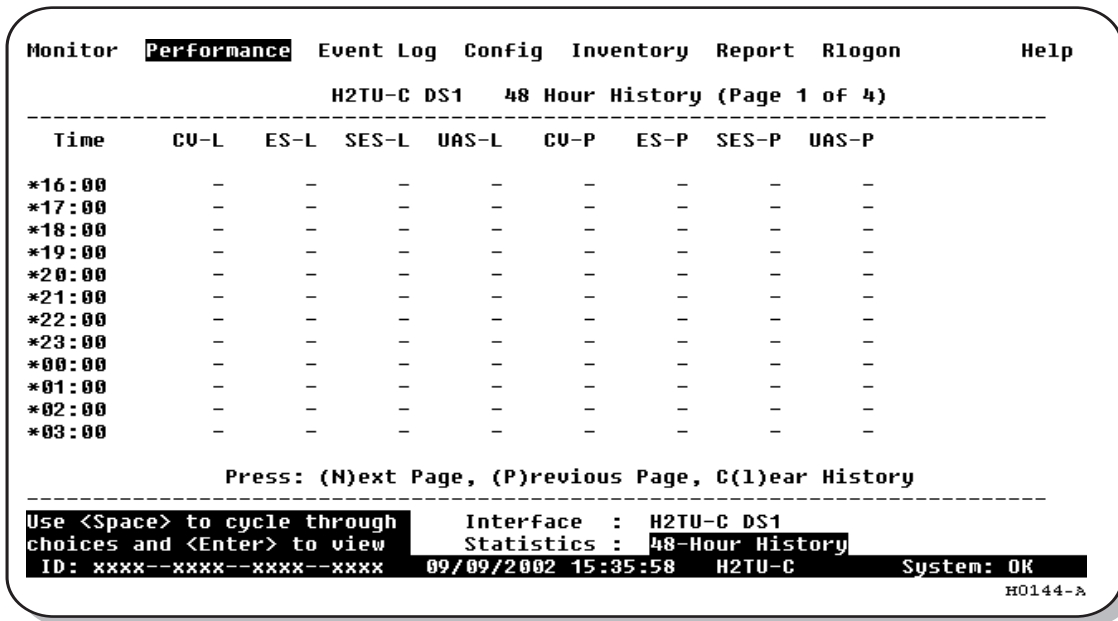

Figure 14. H2TU-C DS1 48-Hour Performance History

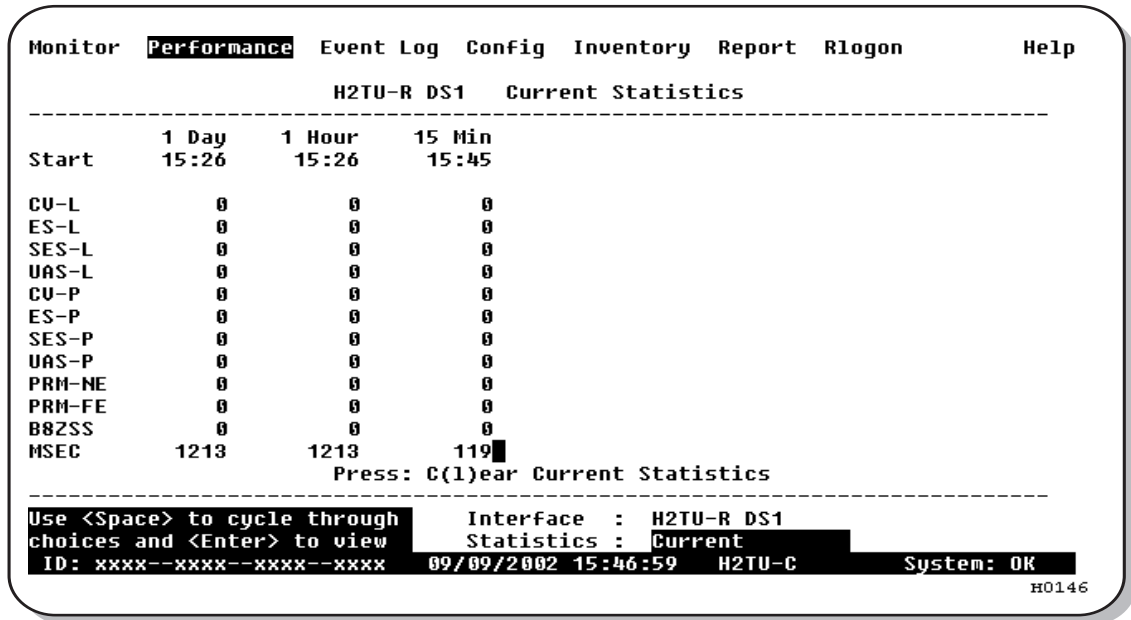

Figure 15. H2TU-R DS1 Current Statistics

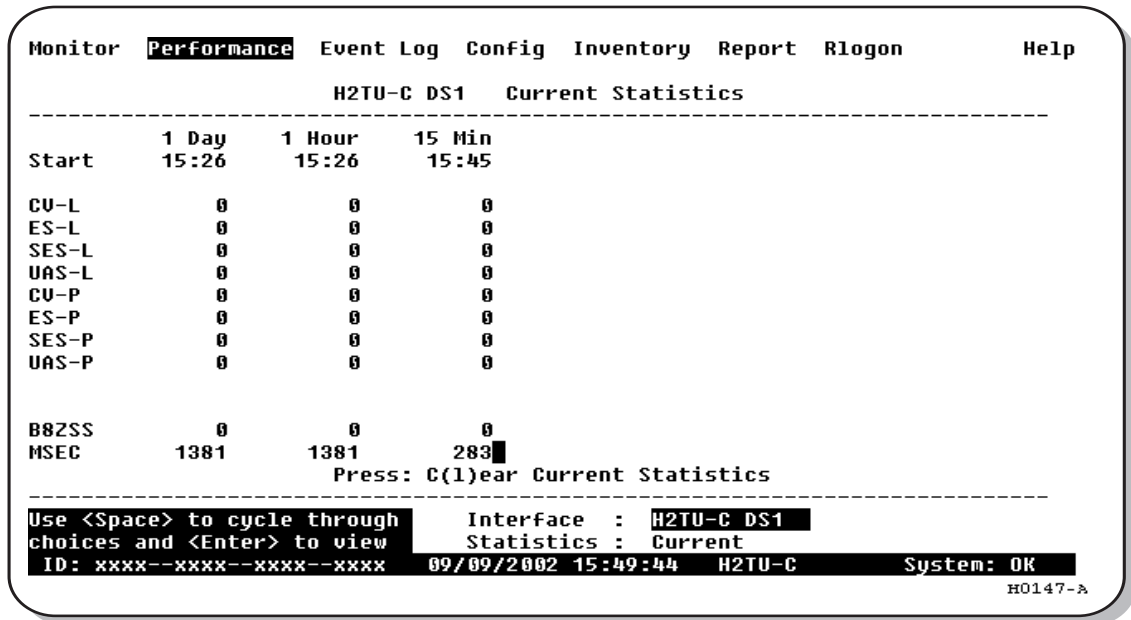

Figure 16. H2TU-C DS1 Current Statistics

Table 10. Error Acronyms Used on the DS1 Performance History Screens

Error Acronym	Description	Error Acronym	Description
CV-L	Code Violation - Line ^(a) Total BPV count.	SES-P	Severely Errored Seconds - Path Seconds with SEF or CRC(ESF) ≥ 320 or FE ^(f) (SF) $\geq 8 (F_T + F_S)$.
ES-L	Errored Seconds - Line Seconds with BPV ≥ 1 .	UAS-P	Unavailable Seconds - Path A second of unavailability based on SES-P or AIS ≥ 1 .
SES-L	Severely Errored Seconds - Line Seconds with BPV plus EXZ ≥ 1544 or LOS ≥ 1 .	PRM-NE ^(b)	Performance Report Monitoring - Near End The PRM from CPE indicates errors, and the signal received from the network at the remote is error-free.
UAS-L	Unavailable Seconds - Line Seconds with LOS ≥ 1 .	PRM-FE ^(b)	Performance Report Monitoring - Far End The PRM from the network indicates errors, and the signal received from the CPE is error-free.
CV-P	Code Violation - Path ^(c) Total count of FE errors for SF or CRC-6 errors for ESF.	B8ZSS ^(d)	B8ZS Monitored Seconds Seconds with B8ZS detection when AMI option is active.
ES-P	Errored Seconds - Path Seconds with SEF ^(e) , CRC(ESF), or FE ^(f) (SF) ≥ 1 .	MSEC ^(b)	Monitored Seconds of the current (15-minute/1-hour/1-day) screen.

(a) Line (L) refers to the AMI DS1 line used to transport the payload.

(b) Appears on H2TU-R Performance History screens.

(c) Path (P) refers to the total framed payload being transported between two points.

(d) Appears on the DS1 Current Statistics screens.

(e) Severely Errored Frame—Two or more frame bit errors occurring in a 0.75 ms interval for SF or a 3 ms interval for ESF.

(f) FE is a frame bit error.

Performance History at the HDSL2 Interface

The HDSL2 interface has 31-day, 48-hour, 25-hour, and current statistic screens for the H2TU-C. Figure 17 and Figure 18 are examples of 31-day and 48-hour performance history screens. Figure 19 on page 30 is an example of a 25-hour performance history screen. Refer to Table 11 on page 31 for descriptions of the kinds of errors reported on all HDSL2 performance screens. Asterisks indicate performance monitoring from the previous day.

Monitor	Performance	Event Log	Config	Inventory	Report	Rlogon	Help
H2TU-C HDSL2 31 Day History (Page 1 of 3)							
Date	CU	ES	SES	UAS	LOSWS		
08/10	-	-	-	-	-		
08/11	-	-	-	-	-		
08/12	-	-	-	-	-		
08/13	-	-	-	-	-		
08/14	-	-	-	-	-		
08/15	-	-	-	-	-		
08/16	-	-	-	-	-		
08/17	-	-	-	-	-		
08/18	-	-	-	-	-		
08/19	-	-	-	-	-		
08/20	-	-	-	-	-		
08/21	-	-	-	-	-		
Press: (N)ext Page, (P)revious Page, C(1)ear History							
Use <Space> to cycle through choices and <Enter> to view				Interface : H2TU-C HDSL2			
ID: xxxx--xxxx--xxxx--xxxx				Statistics : 31-Day History			
				09/09/2002 15:52:26		H2TU-C System: OK	
H0148-A							

Figure 17. H2TU-C HDSL2 31-Day Performance History

Monitor	Performance	Event Log	Config	Inventory	Report	Rlogon	Help
H2TU-C HDSL2 48 Hour History (Page 1 of 4)							
Time	CU	ES	SES	UAS	LOSWS		
*17:00	-	-	-	-	-		
*18:00	-	-	-	-	-		
*19:00	-	-	-	-	-		
*20:00	-	-	-	-	-		
*21:00	-	-	-	-	-		
*22:00	-	-	-	-	-		
*23:00	-	-	-	-	-		
*00:00	-	-	-	-	-		
*01:00	-	-	-	-	-		
*02:00	-	-	-	-	-		
*03:00	-	-	-	-	-		
*04:00	-	-	-	-	-		
Press: (N)ext Page, (P)revious Page, C(1)ear History							
Use <Space> to cycle through choices and <Enter> to view				Interface : H2TU-C HDSL2			
ID: xxxx--xxxx--xxxx--xxxx				Statistics : 48-Hour History			
				09/09/2002 16:02:08		H2TU-C System: OK	
H0149-A							

Figure 18. H2TU-C HDSL2 48-Hour Performance History

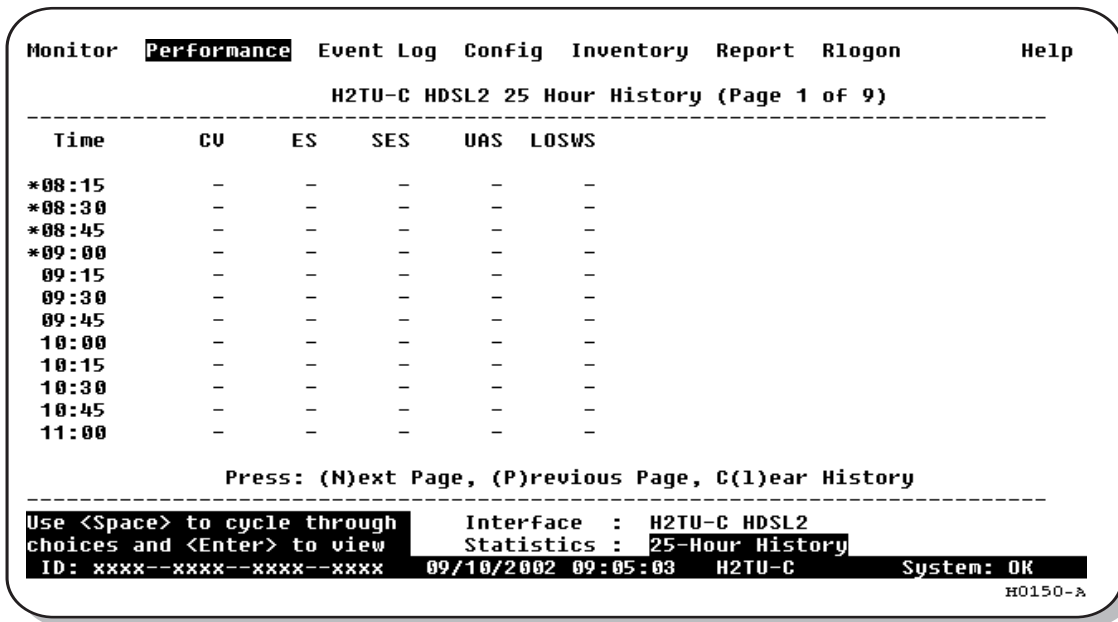

Figure 19. H2TU-C HDSL2 25-Hour Performance History

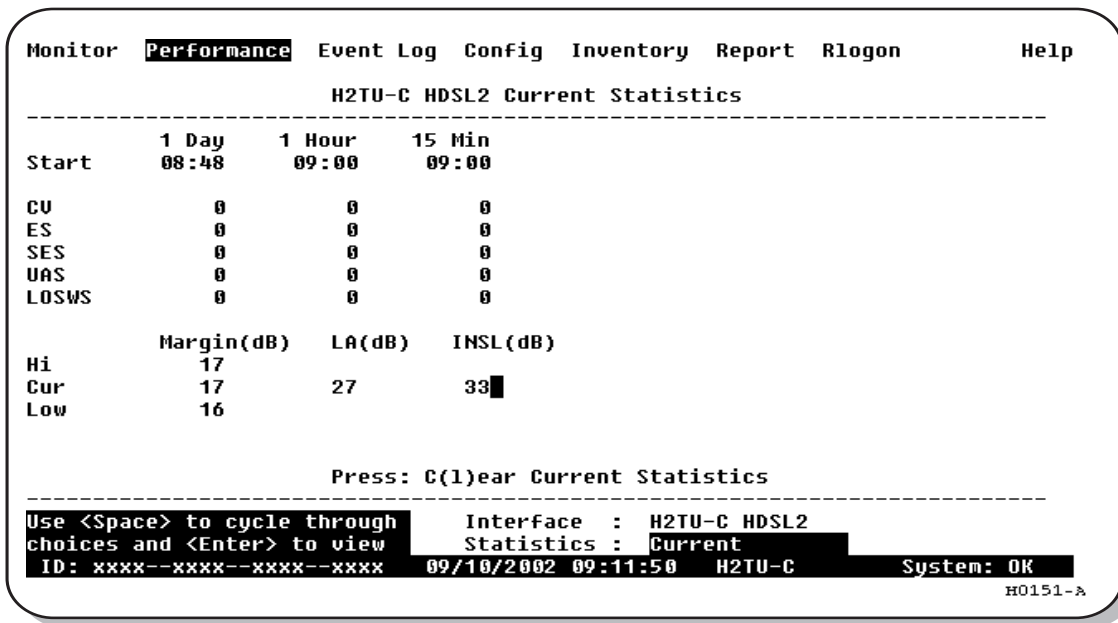

Figure 20. H2TU-C HDSL2 Current Statistics

Table 11. Error Acronyms Used on the HDSL2 Performance History Screens

Error Acronym	Description
CV	Code Violation Total count of HDSL2 CRC errors.
ES	Errored Seconds Seconds with HDSL2 CRC ≥ 1 or LOSW ≥ 1
SES	Severely Errored Seconds Seconds with HDSL2 CRC ≥ 50 or LOSW ≥ 1
UAS	Unavailable Seconds Based on 10 contiguous SES occurrences
LOSWS	Loss of Sync Word Second Seconds with LOSW ≥ 1

USING THE PERFORMANCE SCREENS TO VIEW ALARM DATA

To access the alarm history screens:

- 1 Press **P** to select the Performance menu.
- 2 Press the **SPACEBAR** to select an interface (**H2TU-C DS1**, **H2TU-R DS1**, **H2TU-C HDSL2**, or **H2TU-R HDSL2**), then press **ENTER**.
- 3 Press the **SPACEBAR** until **Alarm History** is selected, then press **ENTER**.
- 4 Press **N** or **P** to page through the alarm history screens.
- 5 Press **L** to clear the selected alarm history screen.

Alarm History at the DS1 Interface

The Alarm History screen reports on a continuous basis the DS1 statistics for the H2TU-C (Figure 21) and the H2TU-R (Figure 22). The types of alarms reported are described in Table 12 on page 33. Current alarms are shown in reverse video.

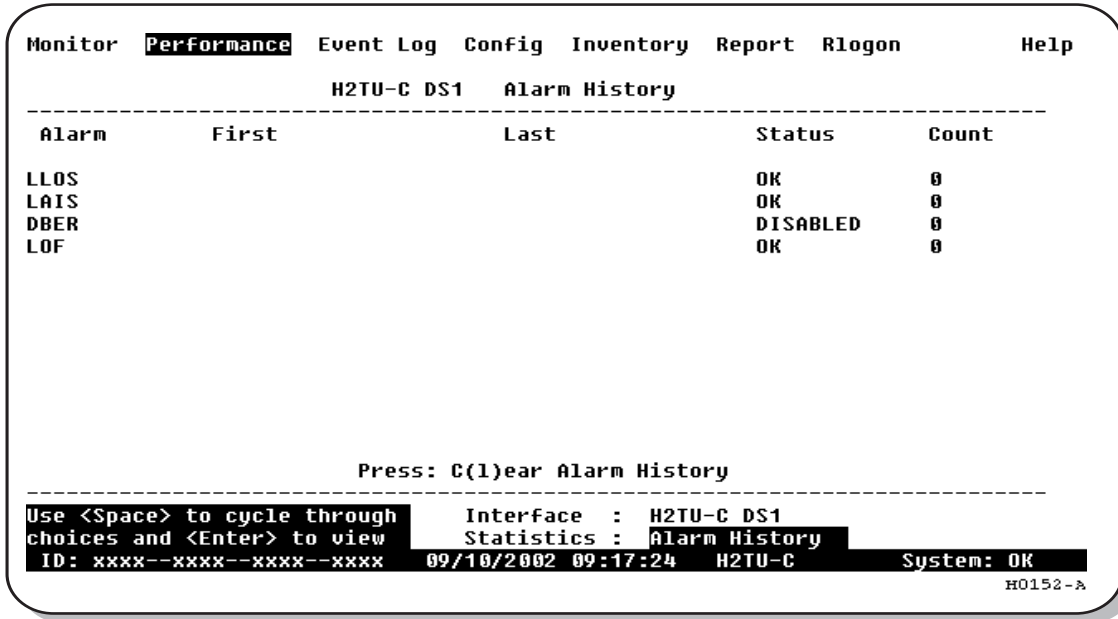

Figure 21. H2TU-C DS1 Alarm History Screen

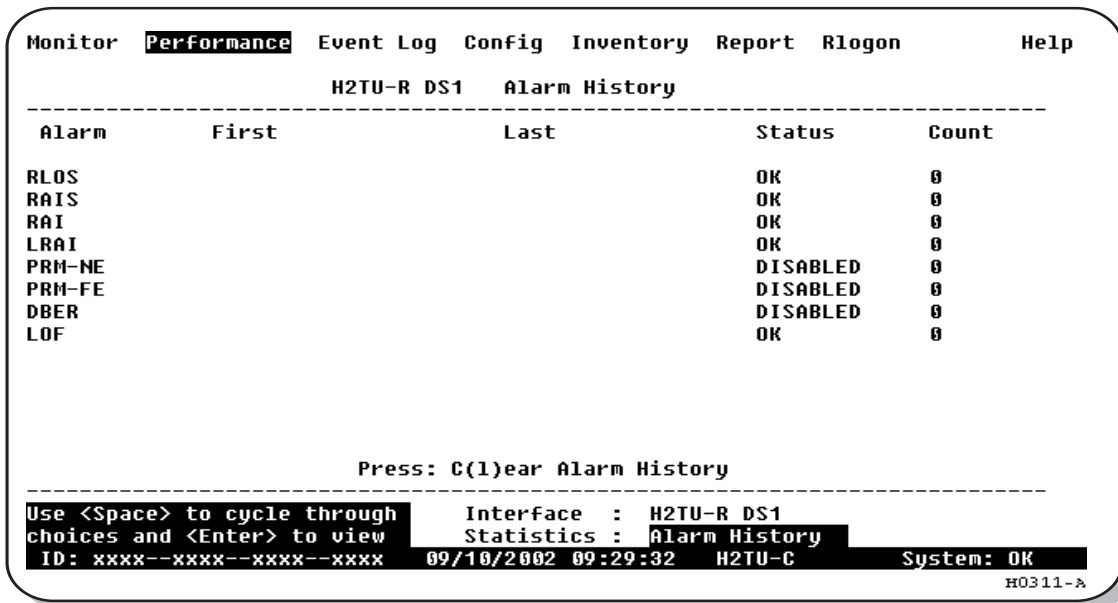

Figure 22. H2TU-R DS1 Alarm History Screen

Table 12. DS1 Alarm Descriptions

Screen Alarm	Front-Panel Alarm	Description
H2TU-C DS1 Alarms (see Figure 21 on page 32)		
LLOS	LLOS	Line (Unit) Loss of Signal—Loss of the H2TU-C DSX-1 input signal.
LAIS	LAIS	Line Alarm Indication Signal—Indicates an AIS (all ones) pattern is being detected at the H2TU-C DS1 input port.
DBER	xxx-DBER	Bit Error Rate—The DS1 BER has exceeded the built-in 24-hour threshold limits of approximately 10^{-6} . (xxx denotes either TUC or TUR.)
LOF	LOF	Loss of Frame—Indicates the incoming DS1 frame pattern is other than the one selected, ESF or SF, by the FRMG option. Only occurs if the FRMG option is set to SF or ESF.
H2TU-R DS1 Alarms (see Figure 22 on page 32)		
RLOS	RLOS	Remote (Unit) Loss of Signal—Loss of the H2TU-R DS1 input signal.
RAIS	RAIS	Remote Alarm Indication Signal—Indicates an AIS (unframed all ones) pattern is being received at the H2TU-R DS1 input port. By default AIS-CI ^(a) is sent towards the network (see “Loopback Summary” on page 42.)
RAI	RRAI	Remote Alarm Indication—Indicates an RAI alarm (yellow) from the CPE with errors from the line unit or network.
LRAI	LRAI	Line (Unit) RAI - Remote Alarm Indication at the H2TU-R—Indicates an RAI alarm (yellow) from the CPE with an error-free signal from the line unit or network. RAI signal is transmitted towards the network.
PRM-NE	PRMN	Performance Report Monitoring - Near End—The count of the PRM-NE register at the H2TU-R exceeds the 10^{-6} BER threshold at 648 events since 12:00:00 AM.
PRM-FE	PRMF	Performance Report Monitoring - Far End—The count of the PRM-FE register at the H2TU-R exceeds the 10^{-6} BER threshold at 648 events since 12:00:00 AM.
DBER	xxx-DBER	Bit Error Rate—The DS1 BER has exceeded the built-in 24-hour threshold limits of approximately 10^{-6} . (xxx denotes either TUC or TUR.)
LOF	LOF	Loss of Frame—Indicates the incoming DS1 frame pattern is other than the one selected, ESF or SF, by the FRMG option. Only occurs if the FRMG option is set to SF or ESF.

(a) AIS-CI is a modified AIS alarm pattern. Equipment not suited to detect AIS-CI still detects this signal as an AIS. AIS-CI is sent toward the network indicating that an LOS (RLOS) or AIS (RAIS) has been received from the CPE.

Alarm History at the HDSL2 Interface

Figure 23 shows the H2TU-C HDSL2 alarm history and Table 13 describes the alarms.

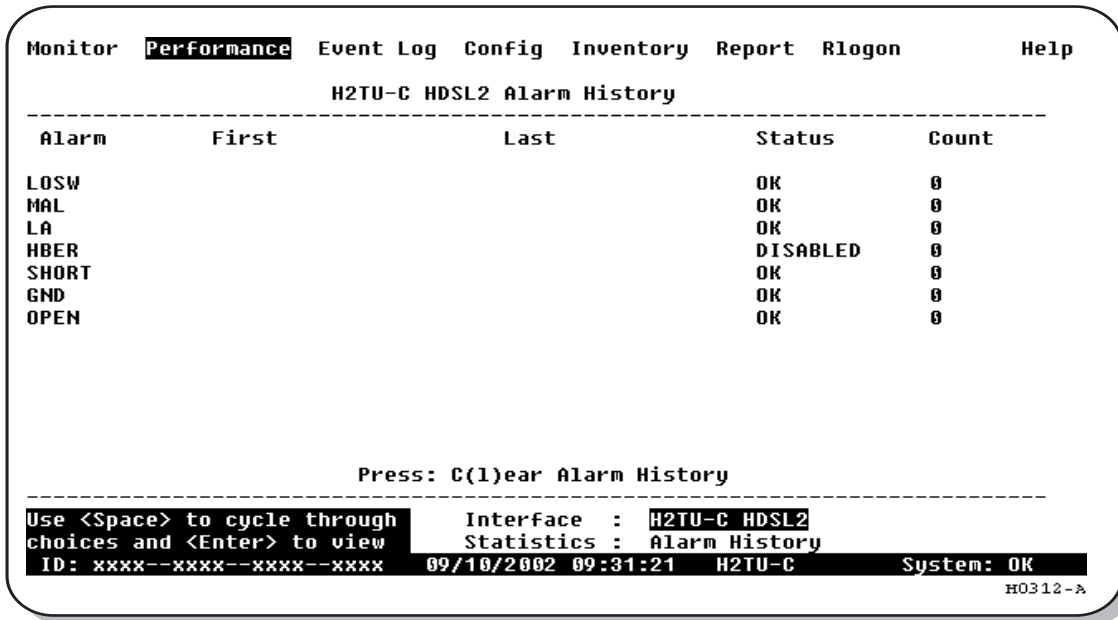

Figure 23. H2TU-C HDSL2 Alarm History Screen

Table 13. HDSL2 Alarm Descriptions

Screen Alarm	Front-Panel Alarm	Description
HDSL2 Alarms at the H2TU-C and H2TU-R		
LOSW	LOSW	Loss of Sync Word—The HDSL2 loop has lost synchronization.
MAL	xxx-MAL	Margin—The margin on the HDSL2 loop has dropped below the minimum threshold value set for the system. (xxx denotes either TUC or TUR.)
LA	xxx-LA	Loop Attenuation—The attenuation on the HDSL2 loop has exceeded the maximum value set for the HDSL2 loop attenuation threshold. (xxx denotes either TUC or TUR.)
HBER	xxx-HBER	Block Error Rate—The HDSL2 BER has exceeded the set threshold limits of 10 ⁻⁶ or 10 ⁻⁷ . (xxx denotes either TUC or TUR.)
HDSL2 Alarms at the H2TU-C only		
SHORT	PWR FEED SHRT	Indicates a short between the Tip and Ring of the HDSL2 pair.
GND	PWR FEED GND	The HDSL2 loop is grounded.
OPEN	PWR FEED OPEN	Indicates a line power open condition.

USING THE SYSTEM EVENT LOG TO TRACK EVENTS

The Event Log displays the date and time of the 100 most recent events (most recent displayed first) and provides a description of each event. Table 14 on page 36 lists the event log messages.

To view a running log of system events, press **E** to select the Event Log.

- Press **N** or **P** to page through the event log.
- Press **T** to return to the top of the log.
- Press **L** to clear the event log.

```

Monitor Performance Event Log Config Inventory Report Rlogon Help
-----
System Event Log (Page 1 of 7)
-----
# Origin Date and Time Entry
1 Management Host 09/10/02 08:47:05 Time set to 08:48:13
2 LU Craft Port 09/09/02 18:35:06 Event Log Reset
3 - EMPTY -
4 - EMPTY -
5 - EMPTY -
6 - EMPTY -
7 - EMPTY -
8 - EMPTY -
9 - EMPTY -
10 - EMPTY -
11 - EMPTY -
12 - EMPTY -
13 - EMPTY -
14 - EMPTY -
15 - EMPTY -

Press: (N)ext Page, (P)revious Page, (T)op of Log, C(L)ear Log
ID: xxxx--xxxx--xxxx--xxxx 09/10/2002 09:33:58 H2TU-C System: OK
H0313-A

```

Figure 24. System Event Log

Event Log Messages

Table 14 lists all the possible messages that can be displayed by the System Event Log screen.

Table 14. *Event Log Messages*

DS1 Alarm History reset
DS1 PM register reset
HDSL2 Alarm History reset
HDSL2 PM register reset
Loop Down (any segment)
Loop Up (any segment)
Provisioning option change: <provisioning mnemonic>: changed from <old> to <new>
CPE DBER alarm (1-day threshold crossed of any PM data except PRM-NE or PRM-FE)
CPE DS1 AIS begins/ends
CPE DS1 LOS begins/ends
CPE PRM-NE BER alarm (at the remote only: 1-day threshold crossed of PRM-NE: trouble on CPE receive)
Current statistics reset
Event Log reset
H2TU-C Power up/down
H2TU-R Power up/down
HDSL2 DC pair open begins/ends on any segment
HDSL2 Ground fault begins/ends on any segment
HDSL2 HBER alarm (threshold crossed) on any segment.
HDSL2 loop attenuation (threshold crossed) on any HDSL2 I/F
HDSL2 margin alarm (threshold crossed) on any HDSL2 I/F
HDSL2 unavailability begins/ends on any segment
Master zero reset
NTWK DBER alarm (1-day threshold crossed of any PM data)
NTWK DS1 LOS begins/ends
NTWK PRM-FE BER alarm (at the remote only: 1-day threshold crossed of PRM-FE: trouble on NTWK far end)
NTWN DS1 AIS begins/ends
Power Feed Open begins/ends
Power Feed Short begins/ends
RAI begins/ends

USING THE REPORT MENU

The Report menu (Figure 25) provides screens containing status and performance monitoring data for line and remote units which can be downloaded to a file for analysis or future reference. Table 15 on page 38 describes the four types of reports provided by the Report menu.

To select each individual report, do the following:

- 1 Press **O** to select Report menu.
- 2 Press the **SPACEBAR** to select a report type and print mode.
 - Continuous Print Mode generates a non-stop version of the report.
 - Page Mode generates a page-by-page version of the report for easy viewing on the screen.
- 3 Use your terminal emulation software (such as HyperTerminal or Procomm) to capture the selected report to your printer. Press **ENTER** to generate. (If Page Mode is selected, press the **SPACEBAR** to continue or **ESC** to quit.)
- 4 End the captured report.
- 5 Press **CTRL + R** to refresh the Report menu screen.

```
Monitor Performance Event Log Config Inventory Report Rlogon Help

Report Type : Full Report
Print Mode : Continuous

Please select report type and print mode by pressing <Space>
then start terminal logging and press <Enter> to generate the report.

ID: xxxx--xxxx--xxxx--xxxx 09/10/2002 09:43:58 H2TU-C System: OK
H0314-A
```

Figure 25. Report Menu - Full Report

Table 15. Report Types

Type	Contains the following information:
Full Report	<ul style="list-style-type: none">• Circuit and unit identifications• Product information• System configuration• Current performance statistics• Alarm history• Performance history• System event log
Short Report	<ul style="list-style-type: none">• Product information• System configuration• Current performance statistics• Circuit and unit identification
System Information Report	<ul style="list-style-type: none">• Circuit and unit identifications• Product information• System configuration
Event Report	<ul style="list-style-type: none">• Circuit and unit identifications• Product information• System event log

TESTING

This section provides information about front-panel system alarms, LOS and AIS response, OCT55 test procedure, and loopback testing.

FRONT-PANEL SYSTEM ALARMS

Table 16 summarizes all possible system alarms in order of priority as they appear on the front panel. When multiple alarms occur, the front-panel display only reports the highest priority alarm. The alarm history screens display alarms also, but provide greater detail (see “Using the Performance Screens to View Alarm Data” on page 31). All alarms that are not inhibited will drive the front-panel Status LED to a flashing red alarm state.

Table 16. Front-Panel System Alarms Summary

Front-Panel Message ^(a)	Alarm	Description	To Inhibit
PWR FEED SHRT ^(b)	Power Feed Short	A short exists between the Tip and Ring of the HDSL2 pair.	Cannot be inhibited.
PWR FEED GND ^(b)	Power Feed Ground	The HDSL2 loop is grounded.	Cannot be inhibited.
PWR FEED OPEN ^(b)	Power Feed Open	A line power open condition exists.	Cannot be inhibited.
LOSW	Loss of Sync Word ^(c)	The HDSL2 loop has lost synchronization.	Cannot be inhibited.
LLOS	Line (Unit) Loss of Signal	Loss of the DSX-1 input signal.	Cannot be inhibited.
RLOS	Remote (Unit) Loss of Signal	Loss of the H2TU-R DS1 input signal.	Disable the RDA (Remote Disconnect Alarm) option. The front-panel Status LED still flashes red and the ALRM RLOS message displays to alert you of the LOS state. LOS is sent towards the network from the H2TU-C. This option prevents the common occurrences of a CPE LOS condition from generating recurring alarms and AIS payloads.
LAIS	Line Alarm Indication Signal	Indicates an AIS (unframed all ones) pattern is being received at the H2TU-C DSX-1 input port.	Cannot be inhibited.
RAIS	Remote Alarm Indication Signal	Indicates an AIS (unframed all ones) pattern is being received at the H2TU-R DS1 input port.	Cannot be inhibited.
LRAI	Line RAI—Remote Alarm Indication at the H2TU-R (Net signal does not have errors.)	Indicates an RAI alarm (yellow) from the CPE with an error-free signal from the line unit or network. RAI signal is transmitted towards the network.	Cannot be inhibited.
RRAI	Remote RAI—Remote Alarm Indication at the H2TU-R (Net signal has errors.)	Indicates an RAI alarm (yellow) from the CPE with errors from the line unit or network.	Cannot be inhibited.
LOF	Loss of Frame	The DS1 input does not contain the ESF or SF frame pattern setting of the FRMG option.	Change FRMG option to AUTO or UNFR.

Continued

Table 16. Front-Panel System Alarms Summary (Continued)

Front-Panel Message ^(a)	Alarm	Description	To Inhibit
xxx-DBER	DS1 Bit Error Rate	The DS1 BER has exceeded the set threshold limits of approximately 10^{-6} . (xxxx denotes either TUC or TUR. If TUC and TUR occur at the same time, then TUC displays.)	Select DIS for the DBER system option.
PRMF	Performance Report Messaging - Far End	Indicates H2TU-R PRM-FE BER threshold is exceeded.	Set DBER threshold to DIS.
PRMN	Performance Report Messaging - Near End	Indicates H2TU-R PRM-NE BER threshold is exceeded.	Set DBER threshold to DIS.
xxx-HBER	HDSL2 Block Error Rate	The HDSL2 BER has exceeded the set threshold limits of 10^{-6} or 10^{-7} . (xxxx denotes either TUC or TUR. If TUC and TUR occur at the same time, then TUC displays.)	Select NONE for the HBER system option.
xxx-MAL	Margin Alarm	The margin on the HDSL2 loop has dropped below the minimum threshold value set for the system. (xxxx denotes either TUC or TUR. If TUC and TUR occur at the same time, then TUC displays.)	Set the Margin Alarm Threshold option to 0 (zero).
xxx-LA	Loop Attenuation	The attenuation on the HDSL2 loop has exceeded the maximum value set for the HDSL2 loop attenuation threshold. (xxxx denotes either TUC or TUR. If TUC and TUR occur at the same time, then TUC displays.)	Set the HDSL2 Loop Attenuation Threshold option to zero.

(a) The message, ALRM, displays prior to any alarm message.

(b) Message displays repeatedly as long as the alarm condition exists and is not included in the priority order.

(c) When the HDSL2 loop loses sync word (LOSW), a system alarm condition exists. However, since the H2TU-C enters the acquiring mode, the front-panel status LED flashes red, and the ACQ or SIG message displays instead of the ALRM message.

Alarm Option for the Digital Loop Carrier Feed

To improve HiGain HDSL2 compatibility with the switch-to-protect features used in the Digital Loop Carrier (DLC) feeder applications, the H2TU-C has an Alarm Pattern (ALMP) option that allows you to select either an AIS or LOS DS1 output payload for the following alarms:

- LOSW on any loop
- LOS DS1

Retiring System Alarms

To retire a system alarm, press the SEL pushbutton and execute an Alarm Cutoff (ACO). An ACO turns the alarm off and replaces the ALRM message with an ACO message. The second part of the ALRM message, which defines the cause of the alarm, remains. Both parts of the message remain until the alarm condition clears or another higher priority alarm occurs.

Remote LOS and AIS Response

Figure 26 shows the different ways the H2TU-R can respond to the network, depending on the configuration of the TLOS, NLBP, RDA, ALMP, and NAIS configuration options described in Table 4 on page 11 and Table 5 on page 12.

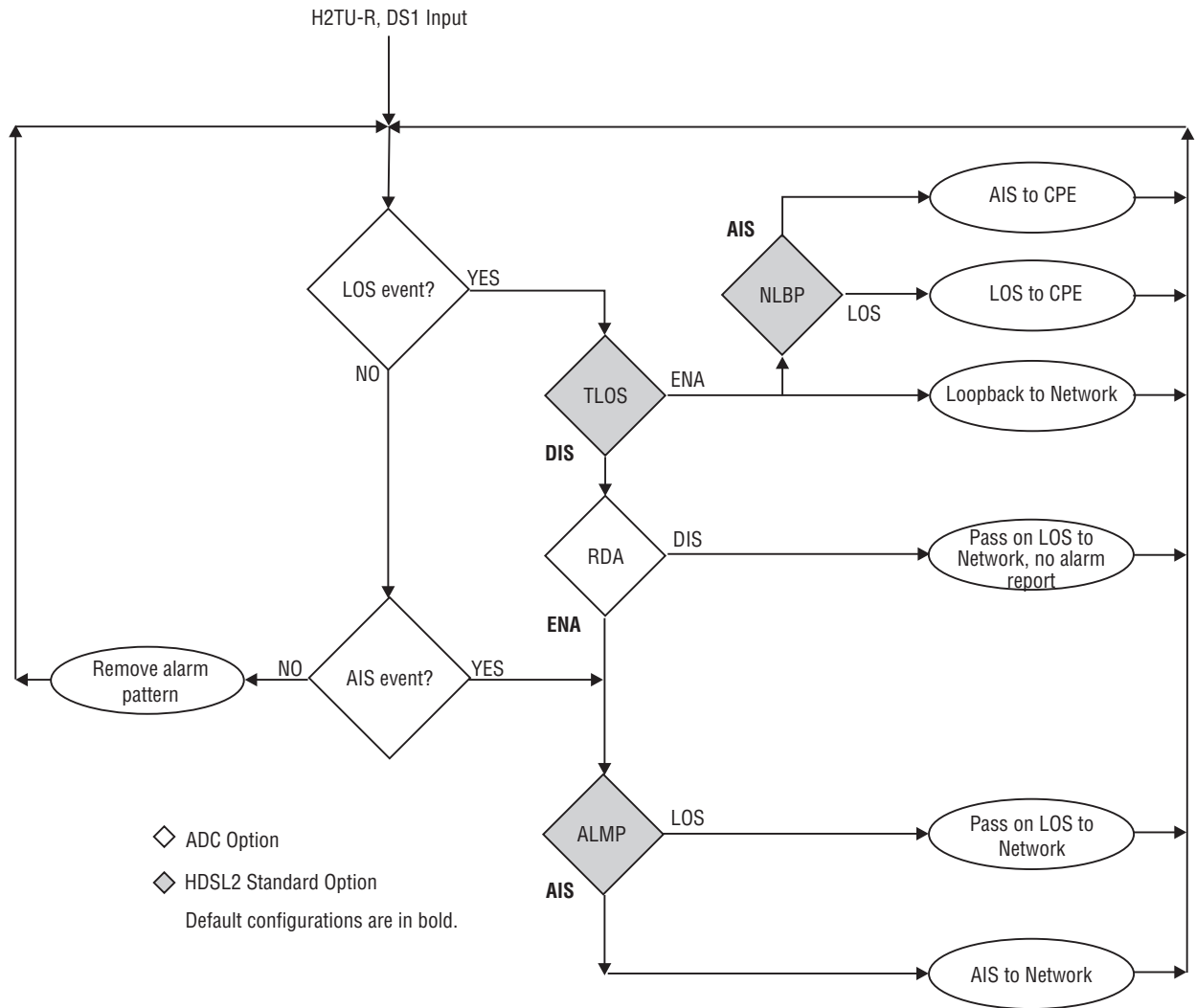

H0343-A

Figure 26. H2TU-R LOS and AIS Response Priorities

OCT55 TEST PATTERN WITH AMI LINE CODE

The OCT55 test pattern can be used in unframed mode to stress the system and verify data integrity. In an SF or ESF framing mode, excessive zero anomalies may occur, which causes the H2TU-C to report ES, SES, and UAS errors according to ANSI T1.231-1997.

LOOPBACK OPERATION

HiGain has a family of loopback options for analyzing circuit functionality. The loopback signal is transmitted and returned to the sending device for comparison. This allows you to verify the integrity of the HDSL2 channels to the H2TU-C, the H2TU-C DSX-1 interface, and the DS1 channels to the customer. Loopback options include:

- Generic Loopback (GNLB) options, including the SmartJack (SMJK) option and double loopbacks (see [Table 17 on page 43](#))
- Special Loopback (SPLB) options (see [“Special Loopback Commands” on page 44](#)) and the following command tables:
 - Addressable Repeater Loopback commands: A1LB, A2LB, A5LB (see [Table 18 on page 48](#))
 - Addressable Repeater Loopback commands: A3LB, A4LB (see [Table 19 on page 50](#))

Loopback commands can be initiated by:

- Selecting the loopback type using the MODE and SEL pushbuttons on the H2TU-C front panel or the manual loopback pushbutton (LBK) on the H2TU-R
- Selecting the loopback type from the Monitor Menu when connected to the craft port of the H2TU-C or H2TU-R
- Entering the loopback code (exceptions are COLB and RULB) into the test equipment connected to the H2TU-C or H2TU-R

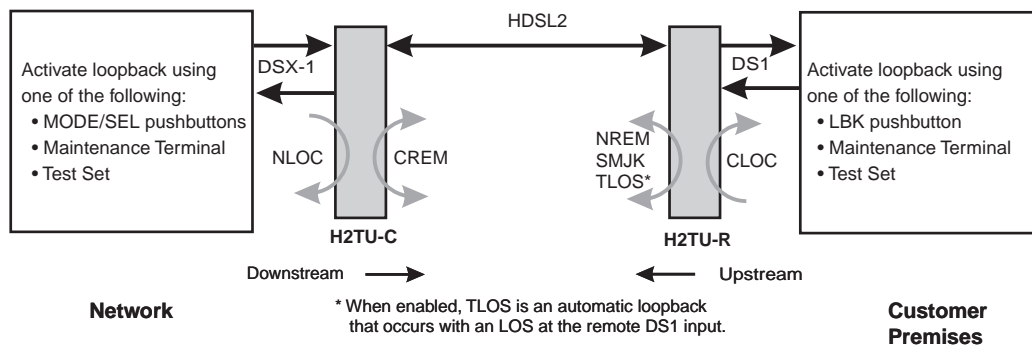

H0344-A

Figure 27. Loopback Summary

Generic Loopback Commands

The HiGain Generic Loopback (GNLB) commands allow you to use inband codes to loop up either NLOC (4-in-7) or NREM (3-in-7) towards the network. In addition, these inband codes loop up CREM (6-in-7) or CLOC (5-in-7) towards the customer. Either loopup condition can be terminated (looped down) with the 3-in-5, SMJK loopdown code. All inband codes must be present for at least 5 seconds before the HiGain HDSL2 system responds. TLOS is a logic loopback caused by loss of the DS1 input from the CI.

[Figure 28 on page 47](#) summarizes the available loopbacks in the system, and [Table 17](#) on this page summarizes the HiGain HDSL2 generic loopback commands.

Table 17. Summary of HiGain HDSL2 Loopback Codes and Activation Methods

Loopback	Code	Description	Method of Activation		
			Test Set	Craft Port	MODE/SEL
NLOC	1111000 4-in-7	DSX-1 signal is looped back to the network at the H2TU-C.	X	X	X
NREM	1110000 3-in-7	DSX-1 signal is looped back to the network at the H2TU-R.	X	X	X
CLOC	1111100 5-in-7	DS1 signal from the customer is looped back to the customer at the H2TU-R.	X	X	X
CREM	1111110 6-in-7	DS1 signal from the customer is looped back to the customer at the H2TU-C.	X	X	X
COLB		Dual loopback at the H2TU-C. DSX-1 signal is looped back to the network at the H2TU-C and signal from the customer is looped back to the customer at the H2TU-C.		X	X
RULB		Dual loopback at the H2TU-R. DSX-1 signal is looped back to the network at the H2TU-R and signal from the customer is looped back to the customer at the H2TU-R.		X	X
SMJK LpUp (PL)	11000 2-in-5	SmartJack Loopup or NID payload (PL) code. Invokes H2TU-R loopback towards network.	X		
SMJK LpUp (ESF-DL)	1111-1111- 0100-1000	SmartJack Loopup or NID (ESF-DL) code. Invokes H2TU-R loopback towards network.	X		
SMJK LpDn (PL)	11100 3-in-5	SmartJack Loopdown or NID payload (PL) code. Removes SMJK, NLOC, NREM, CLOC, and CREM.	X		
SMJK LpDn (ESF-DL)	1111-1111- 0010-0100	SmartJack Loopdown or NID (ESF-DL) code. Removes SMJK, NLOC, NREM, CLOC, and CREM.	X		



HiGain systems feature the SmartJack option which can emulate a Network Interface Device (NID) for loopback testing of the HiGain HDSL2 circuit. SMJK and NREM loopbacks perform the same functions, but their initiation differs. SMJK indicates that the loopback was initiated by the 2-in-5 inband command. NREM, on the other hand, is initiated by the 3-in-7 inband command or by a command issued from the maintenance terminal or the MODE and SEL pushbuttons.

Use the inband commands to enable or disable the SMJK loopback options. The H2TU-C system setting is normally enabled to recognize all inband SmartJack loopback commands.

Special Loopback Commands

In addition to the GNLB loopback command mode, a HiGain HDSL2 system can be configured for one of five special loopback command modes. These are selected from the maintenance terminal System Settings screen (see [Table 7 on page 18](#)) or by using the MODE and SEL pushbuttons (see [Figure 28 on page 47](#)). Once a loopback mode is activated, other loopback commands can be sent by a test set connected to the craft port of the H2TU-C or H2TU-R (see [Table 18 on page 48](#) and [Table 19 on page 50](#) for list of SPLB commands).

A1LB through A5LB are five special, addressable, repeater loopback modes which are supported by the H2TU-C. These loopback modes provide the HiGain HDSL2 system with sophisticated maintenance and troubleshooting tools. A1LB, A2LB, and A5LB are patterned after the Westell addressable DS1 repeater loopbacks. A3LB and A4LB are patterned after the Wescom addressable DS1 repeater loopbacks. All five SPLBs have been enhanced to handle the specific requirements of the following HiGain HDSL2 customers:

- A1LB (Westell) = Southwestern Bell
- A2LB (Westell) = Southwestern Bell
- A3LB (Wescom) = New England Telephone
- A4LB (Wescom Mod 1) = New York Telephone
- A5LB (Westell Mod 1) = Southern New England Telephone (SNET), Southwestern Bell, Pacific Bell

The A1LB loopback selection complies with that proposed for HDSL2 systems in the T1E1.4/92 recommendation with the following additions:

- Query loopback
- IOR (Intelligent Office Repeater) powerdown
- Four loopback time-out choices
- Initiation from either end
- Repeating bit error signatures
- Alternate query loopback

These additions make A1LB identical to A2LB. A1LB is given a separate identity to allow future DS1/E1 enhancements to be added without affecting A2LB.

A5LB differs from A2LB in that A5LB does not block the arming code from exiting the H2TU-C into the network. A1LB and A2LB can be configured to do one of the following:

- Block the arming code (after 2 seconds) from exiting the H2TU-C into the network, and replace it with the AIS code.
- Unblock the AIS code by executing the Far End Activate code. (Since A5LB never blocks the arming code from exiting the H2TU-C, the Far End Activate code is not available in A5LB.)

A3LB differs from A4LB in that A3LB supports the additional (1-in-6) SMJK loopback command.

Manual Loopback Session

A manual loopback session allows you to select any one of the HiGain HDSL2 loopbacks listed in [Table 17 on page 43](#) with the exception of SmartJack loopbacks, which can only be issued by inband commands.

Setting the Loopback Time-Out Option

Before initiating a loopback session, verify that the Loopback Time-Out parameter is set to the desired setting.

- 1 Use the MODE and SEL pushbuttons as described in “[Setting Options through MODE and SEL](#)” on [page 9](#).
(The Loopback Time-Out parameter is also user-selectable from the System Settings screen when using a maintenance terminal.)
- 2 Select the desired setting:
 - NONE (time-out disabled)
 - 20 minutes
 - 60 minutes (default setting)
 - 120 minutes
 - 8 hours
 - 24 hours

Activating Manual Loopback Mode



With the exception of SmartJack, any of the HiGain HDSL2 loopbacks can be executed using the MODE and SEL pushbuttons.

When executing a manual loopback session using the MODE and SEL pushbuttons:

- The next loopback option can be displayed by pressing the MODE pushbutton, however, the previously activated loopback remains active until the SEL pushbutton is pressed, which activates the new loopback.
- If neither pushbutton is pressed for a period of 30 seconds and no loopback is in effect, the manual loopback session terminates, and the display returns to normal mode.
- If any loopback is in effect, the 30-second time-out is inhibited. The active loopback and the manual loopback sessions continue until the loopback times out in accordance with the LBTO setting.
- If there is an active loopback, pressing the MODE and SEL pushbuttons for 3 or more seconds terminates any active loopback, ends the manual loopback session, and returns the display to normal mode.

To initiate a manual loopback session:

- 1 Press both the MODE and SEL pushbuttons on the front panel for at least 5 seconds. The following message appears on the front-panel display:
MAN LPBK NLO?
- 2 Press SEL to activate NLOC. The display changes to MAN LPBK NLOC.
- 3 Press MODE to advance to the next available loopback:
 - NRE? = NREM
 - CRE? = CREM
 - CLO? = CLOC

- COL? = dual loopback at H2TU-C.
- RUL? = dual loopback at H2TU-R.

4 Press SEL to activate the selected loopback. The previous loopback is terminated.

Once a loopback is selected and activated, the loopback stays active until it times out (based on the LBTO setting). When a loopback times out, the display returns to the normal display mode.

You can terminate loopbacks manually and exit the MAN L_PBK mode by simultaneously pressing the MODE and SEL pushbuttons for 3 or more seconds. If no loopback is active, the MAN L_PBK mode automatically terminates after 30 seconds.

All loopbacks (except dual loopbacks) can be initiated by inband commands in the DS1 payload. Loopbacks can also be initiated by a command from the HiGain HDSL2 system (front-panel pushbuttons or maintenance screen selections). Therefore, whenever a loopback is active, the method by which it was activated is indicated in the Monitor screen by the annotation HG or PL adjacent to the identified loopback. For example, NREM-HG indicates that the loopback was initiated by the HiGain HDSL2 system.



SMJK loopback commands are only activated by inband commands. Dual loopback commands are only activated by the front-panel pushbuttons or maintenance screen selections.

LOOPBACK TEST PROCEDURES

The following sections provide step-by-step test procedures for verifying the integrity of the HDSL2 channels at every module location as well as the DS1 channels to the customer and the local DSX-1 interface.

General Troubleshooting Tips

If trouble is encountered on the DSX-1 interface of the H2TU-C, verify that the:

- H2TU-C is making a positive connection with its mounting-assembly (shelf) connector.
- H2TU-C internal equalizer is set to the correct distance range per [Table 6 on page 17](#). All equalizers should be set to the distance from the DSX-1 to the shelf.

The transmit and receive DSX-1 ports have splitting access jacks and miniature 210-series, bridging jacks as shown in [Figure 1 on page 3](#). Connecting one cable between the two bridging jacks and another between the two LINE jacks splits the IN and OUT and creates metallic loopbacks towards both the DSX-1 and the H2TU-C. If separate plugs are inserted into both LINE jacks with the other end disconnected, the BRG jacks can be used to send and receive test patterns towards the DSX-1.

GNLB Test Procedures

[Figure 28 on page 47](#) is a graphical representation of the various loopback configurations with the associated GNLB commands shown. Also, refer to [Table 17 on page 43](#) for a description of these commands.

To perform the GNLB loopback test procedure:

- 1 Have the CO tester send the NREM (3-in-7) inband loopup code for 5 seconds. You should be able to observe the NREM message on the front-panel display. (The Status LED on the front panel should be green, and the loopback mode should also be identified on the Monitor screen.)
- 2 Have the CO tester transmit a DS1 test signal towards the H2TU-C and verify that the returned (looped) signal to the test set is error-free.
- 3 If step 2 fails, have the CO tester transmit the 3-in-5 inband loopdown code.

- 4 Have the CO tester send the NLOC (4-in-7) inband loopup for 5 seconds. You should be able to observe the NLOC message on the front-panel display. (The Status LED on the front panel should be yellow, and the loopback mode should also be identified on the Monitor screen.)
- 5 Repeat Step 2. If the test passes, the problem is in the downstream direction. If it fails, the problem is in the upstream direction.

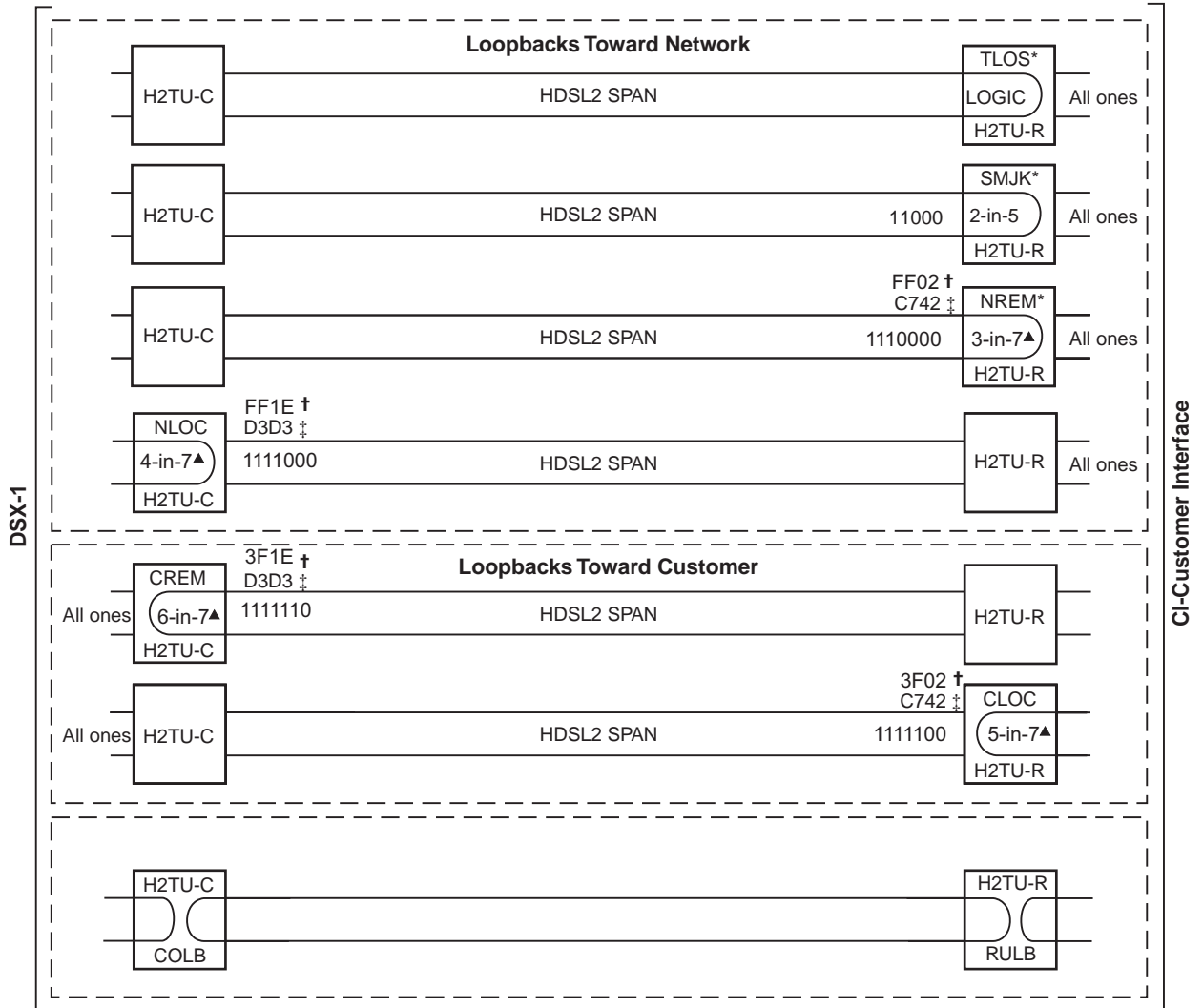

* Set the NLBP option to AIS to send AIS (indicated by an all ones pattern) for any network loopback.

H0012-A

† A3LB and A4LB loopback codes.

‡ A1LB, A2LB, and A5LB loopback codes.

▲ GNLB loopback codes.

Figure 28. Loopback Modes

A1LB, A2LB, and A5LB Test Procedures

Using the codes listed in Table 18, a network tester can activate NLOC or NREM loopbacks (or SMJK, if enabled). A tester at the customer premises can activate CLOC, CRG, or CREM loopbacks. All loopbacks shown in Table 18 can also be initiated from the H2TU-C front-panel MODE and SEL pushbuttons (see “Setting Options through MODE and SEL” on page 9).

Table 18. Addressable Repeater Loopback Commands (A1LB, A2LB, A5LB)

Name	Binary Code ^(a) (Hexadecimal Equivalent)	Description
ARMING or NI LPBK (inband)	11000-11000 ...	Arming code
ARMING or NI LPBK (ESF Data Link)	1111-1111-0100-1000 (FF48)	Arming code
LPDN or DISARM (inband)	11100-11100 ...	Disarming code
IR LPDN or DISARM (ESF Data Link)	1111-1111-0010-0100 (FF24)	Disarming code
IOR LPBK (NLOC or CREM) 230-232 bit errors 229-231 bit errors ^(b)	1101-0011-1101-0011 (D3D3)	NLOC—DSX-1 signal is looped back to the network at the H2TU-C. CREM—DS1 signal from customer is looped back to the customer at the H2TU-C.
ILR-2 LPBK (NREM or CLOC) 20 bit errors ^(c)	1100-0111-0100-0010 (C742)	NREM—DSX-1 signal is looped back to the network at the H2TU-R. CLOC—DS1 signal from customer is looped back to the customer at the H2TU-R.
IR LPDN	1001-0011-1001-0011 (9393)	Loopdown (H2TU-C or H2TU-R)
IR QUERY LPBK	1101-0101-1101-0101 (D5D5)	Query loopback
IR ALTERNATE QUERY LPBK	1101-0101-1110-1010 (D5EA)	Alternate query loopback
TIME-OUT OVERRIDE	1101-0101-1101-0110 (D5D6)	Loopback time-out override
Far End NI ACTIVATE ^(d)	1100-0101-0101-0100 (C554)	Unblock AIS
IOR POWER DOWN (H2TU-C) ^(e)	0110-0111-0110-0111 (6767)	Removes HDSL2 line power

- (a) The leftmost bit arrives first in all sequences. The detection algorithm functions reliably with a random 10^{-3} BER on the facility. The entire arming and loopback sequence can also be initiated at the remote H2TU-R location.
- (b) The H2TU-R identifies CREM (and the H2TU-C identifies NLOC) with 231 bit errors, including the frame bits. When framed data is being sent in the Auto framing mode, the number of the 231 bit errors detected by the test set varies from 229 to 231, depending on whether or not the test set counts frame errors as bit errors and on the number of frame bits contained in the block of 231 error bits. The H2TU-R and H2TU-C generate this bit pattern in a series of discontinuous bursts containing 20-bit errors each, including frame bits. Those test sets that do not count frame error bits as data bit errors will indicate fewer bits than the H2TU-R and H2TU-C transmit for a CI and NI loopback.
- (c) The H2TU-R is assigned the ILR-2 loopback code. It responds with 20 bit errors (excluding the frame bits).
- (d) Sending the Far End NI Activate code is not required in A5LB because it is always activated.
- (e) The IOR Power Down code must remain present for the duration of the powerdown mode. When this code is removed, the HiGain HDSL2 system returns to its normal unlooped and unarmed state.

To perform the A1LB, A2LB, and the A5LB loopback test procedures:

- 1 Send the inband Arming and NI LPBK code 11000 to the H2TU-C for at least 5 seconds.
- 2 Monitor the output of the H2TU-C for the return of the pattern. Return of the pattern indicates one of the following:
 - The H2TU-R has looped up (if the SMJK Loopback option is enabled).
 - An external NID has looped up (if the SMJK Loopback option is disabled), and the H2TU-C and H2TU-R have been armed.
- 3 Verify, if possible, that the H2TU-R Loopback LED is either flashing yellow at four times per second (indicating that the system is armed), or is a steady yellow (indicating that it is both armed and in SMJK loopback). The H2TU-C Status LED also flashes yellow when the system is armed.



If the Arming code is not returned after 5 seconds, the system may be armed, but there is no active loopback.

- 4 Once armed, the H2TU-C can be looped back by sending Intelligent Office Repeater (IOR) LPBK activation code 1101-0011-1101-0011 (D3D3) for at least 5 seconds. You should observe the following activation response pattern in the order presented:
 - a 2 seconds of AIS (all ones pattern)
 - b 2 seconds of returning data pattern
 - c Logic errors (including the frame bit) occurring in the returned pattern comprising:
 - 231 errors, if IOR LPBK (H2TU-C) was sent
 - 20 errors, if ILR-2 (H2TU-R) was sent
 - d Normal looped data

This error pattern repeats every 20 seconds as long as the IOR loopback pattern is being sent. This also applies to ILR, Time-Out Override, and Query commands.

The H2TU-C is now in logic loopback if the IOR NLOC loopback command was sent. The Time-Out Override command or a Loopdown command can override the selection made for the loopback time-out (see [“Setting the Loopback Time-Out Option” on page 45](#)). If the Time-Out Override code 1101-0101-1101-0110 (D5D6) is received after activating a loopback, then the automatic timed expiration of the loopback is inhibited. If this Time-Out Override is sent, then the only way to loop the H2TU-C down is to do one of the following:

- Issue the Intelligent Repeater (IR) loopdown (LPDN) code 1001-0011-1001-0011 (9393).
- Issue the NI LPDN and Disarm inband code 11100 or the ESF-DL code (FF24).



The Time-Out Override function is only valid for the current active loopback. The automatic time-out timer is restored during subsequent loopback sessions.

- 5 Once the test is complete, do one of the following:
 - If the system is to loop down but remain Armed, send the IR LPDN code.
 - If all the equipment is to be looped down, disarmed, and returned to normal operation, send the disarm inband code 11100 or the ESF-DL code (FF24).



The Armed mode has an automatic time-out of 120 minutes, but this timer is reset to 120 for any of the following events:

- Loopback terminates (manually or time-out)
- Query
- Alternate query
- Far End activate
- Another ARM command

This timer is inhibited while any of the valid command codes are being sent. Once the codes are removed, the timer restarts at 120.

A3LB and A4LB Test Procedures

The H2TU-C can be looped back by sending the Addressable Office Repeater (AOR) LPBK activation code 1111-1111-0001-1110 (FF1E) for at least 5 seconds. This causes the H2TU-C to enter the NLOC state. The Loopback Time-Out setting (see “[Setting the Loopback Time-Out Option](#)” on page 45) determines the duration of this loopback unless it is overridden by the reception of a second identical 16-bit loopup command before the timer expires. When this time-out override state exists, the only way to loop the H2TU-C down is to issue one of the three loopdown commands listed in [Table 19](#). The automatic time-out mode is restored during subsequent loopback sessions.

[Table 19](#) summarizes the codes required to execute Addressable 3 (A3LB) and Addressable 4 (A4LB) repeater loopback commands. All code sequences must be present for at least 5 seconds.

Table 19. *Addressable Repeater Loopback Commands (A3LB and A4LB)*

Name	Binary Code ^(a) (Hexadecimal Equivalent)	Description
NLOC	1111-1111-0001-1110 (FF1E)	H2TU-C loopup from NI
CREM	0011-1111-0001-1110 (3F1E)	H2TU-C loopup from CI
NREM	1111-1111-0000-0010 (FF02)	H2TU-R loopup from NI
CLOC	0011-1111-0000-0010 (3F02)	H2TU-R loopup from CI
SMJK	11000-11000-11000 ...	H2TU-R loopup from NI
SMJK	100000 100000 100000 ...	H2TU-R loopup from NI ^(b)
SMJK	1111-1111-0100-1000 (FF48)	H2TU-R loopup from NI (ESF-DL)
Loopdown	11100-11100-11100 ...	H2TU-C and H2TU-R loopdown from NI OR CI
Loopdown	100-100-100 ...	H2TU-C and H2TU-R loopdown from NI OR CI
Loopdown	1111-1111-0010-0100 (FF24)	H2TU-C and H2TU-R loopdown from NI OR CI (ESF-DL)

(a) The leftmost bit arrives first in all sequences. The detection algorithm functions reliably with a random 10^{-3} BER on the facility. The entire arming and loopback sequence can also be initiated at the remote H2TU-R location.

(b) Not supported by A4LB.

TESTING WITH H2TU-C BERT GENERATOR

The H2TU-C BERT Generator screen allows transmission of a selected test signal from the H2TU-C towards either the network (NET) or customer (CPE). Bit error rates are calculated and display on the Monitor screen.



It is not recommended using the Bit Error Rate Tester from the remote and line unit at the same time.

- 1 Press **C** to select the Config menu.
- 2 Use the **↑** and **↓** arrow keys to select **BERT Generator**, then press **ENTER**.
- 3 Use the arrow keys to select an option and press the **SPACEBAR** to cycle through the settings. Refer to [Table 20](#) for a list of BERT generator option settings.
- 4 Press **ENTER** to activate your choice.
- 5 To view BERT status, press **ESC** twice, then use the **←** arrow key to select the **Monitor** menu.
- 6 Press **ENTER**. You can exit the status screen while signal generation is active.

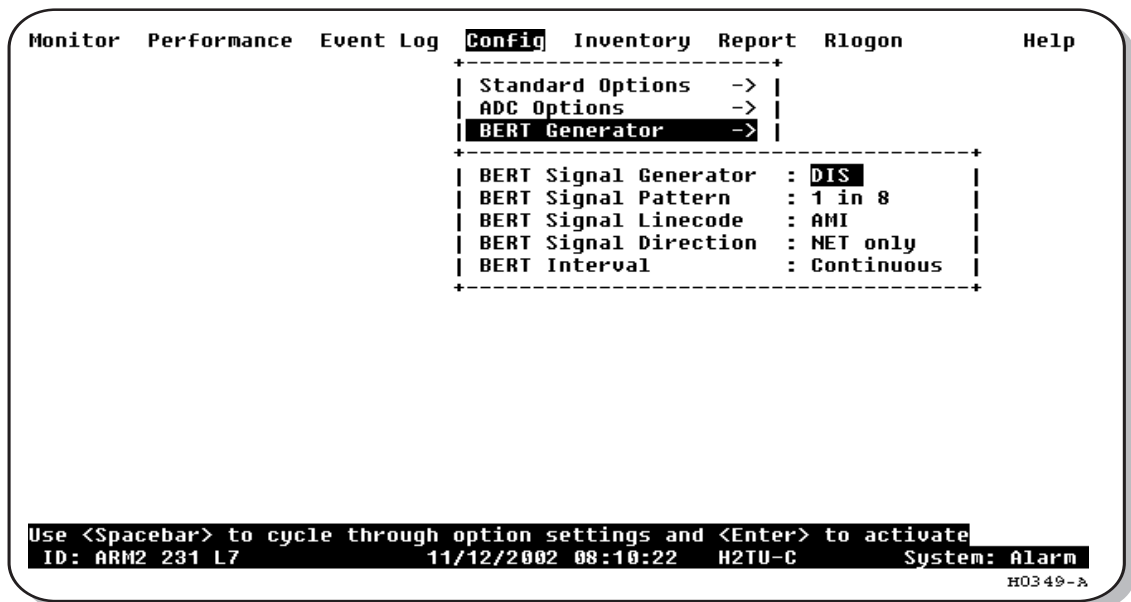

Figure 29. H2TU-C BERT Generator Screen

Table 20. BERT Signal Generator Option Settings

Option	Description ^(a)
BERT Signal Generator	Enabled (ENA) or Disabled (DIS)
BERT Signal Pattern	1:8 pattern, 2:8 pattern, 3:24 pattern, 2^{23-1} pseudo random, 2^{20-1} pseudo random, 2^{15-1} pseudo random
BERT Signal Linecode	AMI or B8ZS
BERT Signal Direction	Toward CPE or toward NET
BERT Interval	5 minutes, 60 minutes, Continuous (default)

(a) Default values are in bold.

TESTING WITH H2TU-R BERT GENERATOR

The H2TU-R BERT Generator screen allows transmission of a test signal from the H2TU-R towards either the network (NET) or customer (CPE). Bit error rates are calculated and display on the Monitor screen.

- 1 Press **R** to logon remotely, then press **C** to select the Config menu.
- 2 Use the **↑** and **↓** arrow keys to select **BERT Generator**, then press **ENTER**.
- 3 Use the arrow keys to select an option, then press the **SPACEBAR** to cycle through the settings. Refer to [Table 20 on page 51](#) for a list of BERT Generator option settings.
- 4 Press **ENTER** to activate your choice.
- 5 To view BERT status, press **ESC** twice, then, using the **←** arrow key to select the **Monitor** menu, press **ENTER**.
- 6 Press **R** to return to the H2TU-C logon screen. You can exit the status screen while signal generation is active.

```

Monitor Performance Event Log Config Inventory Report Rlogout Help
+-----+
| Standard Options -> |
| ADC Options -> |
| BERT Generator -> |
+-----+
| BERT Signal Generator : DIS |
| BERT Signal Pattern : 1 in 8 |
| BERT Signal Linecode : AMI |
| BERT Signal Direction : NET only |
| BERT Interval : Continuous |
+-----+

Use <Spacebar> to cycle through option settings and <Enter> to activate
ID: ARM2 231 L7 11/13/2002 08:20:13 H2TU-R System: OK
H0350-A

```

Figure 30. H2TU-R BERT Generator Screen



The test pattern is sent out from the remote unit towards the network (toward NET) or towards the customer (toward CPE). Both test payloads must be looped back so they can be returned to the unit for BER detection.

Tests done towards the NET must be looped at some point at or beyond the network. The test payload, for the NET direction, also passes back and forth over the HDSL2 link to the H2TU-R before it is analyzed for errors. Tests done towards the CPE should be looped back at some external point beyond the remote unit, or they can be looped back internally by a higher loopback, such as NREM.

APPENDIX A - SPECIFICATIONS

Power

HDSL2 Span Voltage	0 or -180 Vdc \pm 5 Vdc
CO Supply	-48 Vdc nominal (-42.5 Vdc to -56.5 Vdc) See "Power Consumption," "Maximum Power Dissipation," and "Maximum Current Drain" on page 54.
Electrical Protection	Secondary surge and power cross protection on HDSL2 ports. Requires external primary protection.
Fusing	Internal; connected to "FUSE ALARM" output on pin 32. See "Fuse Alarm" on page 56.

Environmental

Operating Temperature	-40°F to +149°F (-40°C to +65°C)
Operating Humidity	5% to 95% (non-condensing)

Physical

Height	5.9 in. (15.0 cm)
Width	1.4 in. (3.5 cm)
Depth	10 in. (25.4 cm)
Weight	0.5 lb (.23 kg)
Mounting	220 mechanics shelves

HDSL2

Line Rate	1.552 Mbps OPTIS
Transmission	Full duplex
Media	One non-loaded, copper, two-wire cable pair
Output	+16.8 dBm \pm 0.5 dBm at 135 Ω (0-450 kHz) at CO side +16.5 dBm \pm 0.5 dBm at 135 Ω (0-350 kHz) at remote side
Line Impedance	135 Ω
Maximum Insertion Loss	35 dB at 196 kHz
Maximum Loop Attenuation	28 dB
Start-up Time	30 sec. typical, 1 min. maximum per span

DSX-1

Line Rate	1.544 Mbps \pm 200bps
Line Format	AMI or B8ZS
Frame Format	ESF, SF, or UNFR
Line Impedance	100 Ω
Pulse Output	6 V ^{pk-pk} pre-equalized for 0-655 feet of ABAM cable
Input Level	+1.5 to -7.5 dB DSX

System

One-way DS1 Delay	<500 μ s per span
Wander (Looped)	Meets MTIE T1.101 requirements
Wideband Jitter (Looped)	0.2 UI maximum
Narrowband Jitter (Looped)	0.1 UI maximum

POWER CONSUMPTION

The three most important power parameters of an H2TU-C are its maximum power consumption, maximum power dissipation, and maximum current drain.

Table 21 lists these parameters for an H2TU-C providing line power on 9 kft, 26 AWG loops and those H2TU-C parameters when the remote unit (H2TU-R-402 List 7) is receiving local power.

Table 21. H2TU-C Power Parameters

Remote Unit Power Source	-48 Vdc Power Consumption (Watts) Maximum	Power Dissipation (Watts) Maximum	-42.5 Vdc Current (mA) Maximum
Line power	7.8	4.7	185
Local power (with sealing current)	6.5	4.5	140

MAXIMUM POWER DISSIPATION

Maximum power dissipation measures the amount of power converted into heat by a unit. This heat builds up within the unit and contributes to the total heat generated in the space around the unit. The maximum power dissipation determines the maximum number of fully loaded shelves per bay without exceeding the maximum allowable power dissipation density in watts per square foot to comply with GR-63.

In COs, the maximum power dissipation for open-faced, natural convection-cooled mountings is limited to 134.7 watts per square foot per GR-63-CORE. The footprint of a standard 28-slot, 23-inch HMS-317 shelf is 7.024 square feet. Therefore, the maximum bay dissipation is limited to 946 watts. Use this limit and the parameters in Table 21 to determine the maximum number of H2TU-C circuits that can occupy one CO bay.



The situation above assumes the entire CO is subjected to the maximum power density. In more favorable conditions, you can increase the number of shelves per bay without jeopardizing the thermal integrity of the CO.

The thermal loading limitations imposed when using the H2TU-C in a Controlled Environmental Vault (CEV) or other enclosures are determined by applying its power parameters to the manufacturer's requirements for each specific housing.

-48 Vdc is the maximum total power that the H2TU-C consumes or draws from the shelf power source. If the H2TU-C is in a location remote to the CO it is serving, you can use this parameter to determine the battery capacity required to maintain an 8-hour, standby battery reserve for emergency situations. The battery capacity, therefore, limits the maximum number of line units that can be installed in a remote enclosure. Use Table 21 and the battery capacity to determine the number of line units that can be installed.

MAXIMUM CURRENT DRAIN

The Maximum Current Drain is the maximum current drawn from the shelf power supply when it is at its minimum voltage (-42.5 Vdc). This determines the shelf fusing requirements. Use the -42.5 Vdc current data in Table 21 to determine the shelf fusing requirements for your particular H2TU-C applications.

LOOP ATTENUATION

Each loop has no more than 35 dB of loss at 196 kHz, with driving and terminating impedances of 135Ω as shown in [Table 22](#) below. This is equivalent to no more than 28 dB loop attenuation.

Table 22. HDSL2 Reach Chart

Cable Gauge	Insertion Loss ^(a) at 196 kHz (dB/kft)	Loop Attenuation (dB/kft)	Maximum Reach (kft)	Ω per kft
26/0.4 mm	3.88	3.1	9	83
24/0.51 mm	2.84	2.2	12	52
22/0.61 mm	2.18	1.7	16	32
19/0.91 mm	1.54	1.2	23	16

(a) Insertion Loss = 1.25 times loop attenuation

CARD-EDGE CONNECTOR

[Figure 31 on page 56](#) shows the pin assignments of the card-edge connector on the H2TU-C card. Active pins are shown in black.

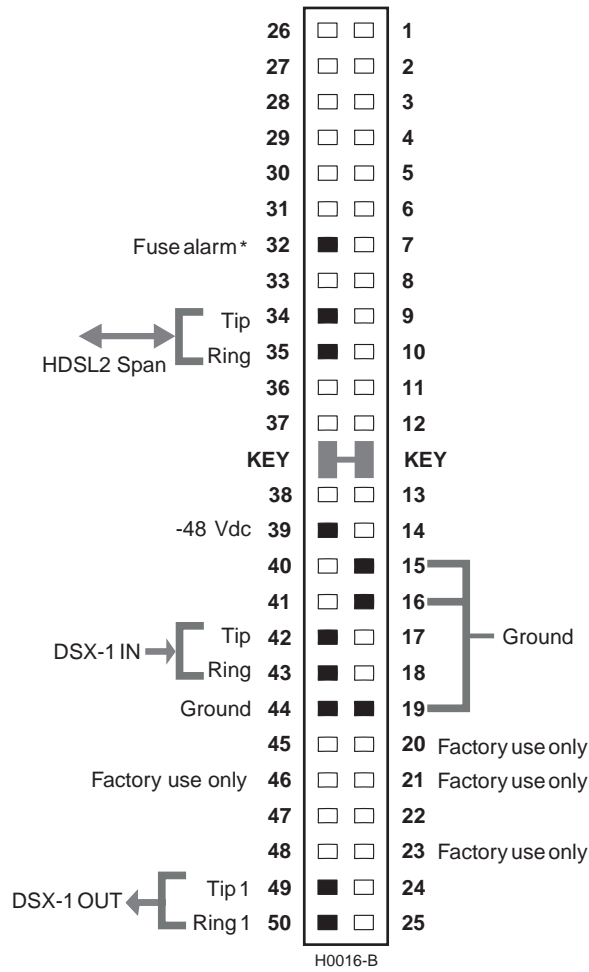

* Fuse alarm is normally floating and at -48 Vdc when activated.
 ** Active pins are solid black.

Figure 31. Card-Edge Connector

Fuse Alarm

Pin 32 on the card-edge connector (Figure 31) is a fuse alarm that is driven to -48Vdc through a diode whenever its onboard fuse opens.

CRAFT PORT

Figure 32 shows the pinout for the craft port connector and its connection to a DB-9 or DB-25 connector on a maintenance terminal.

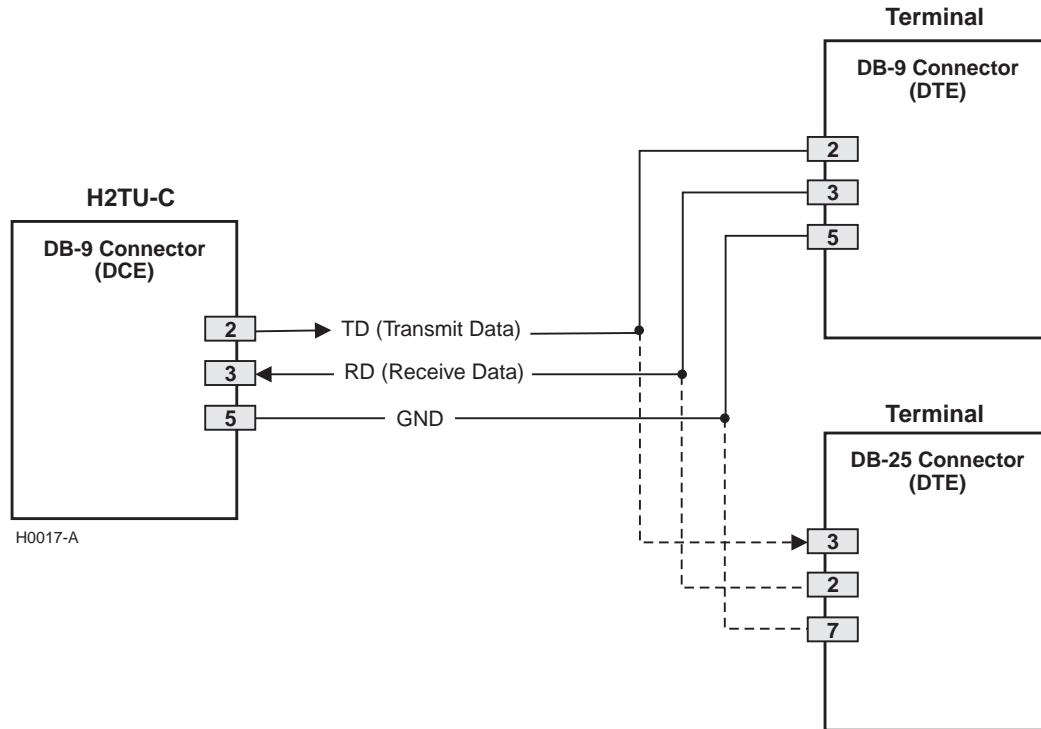
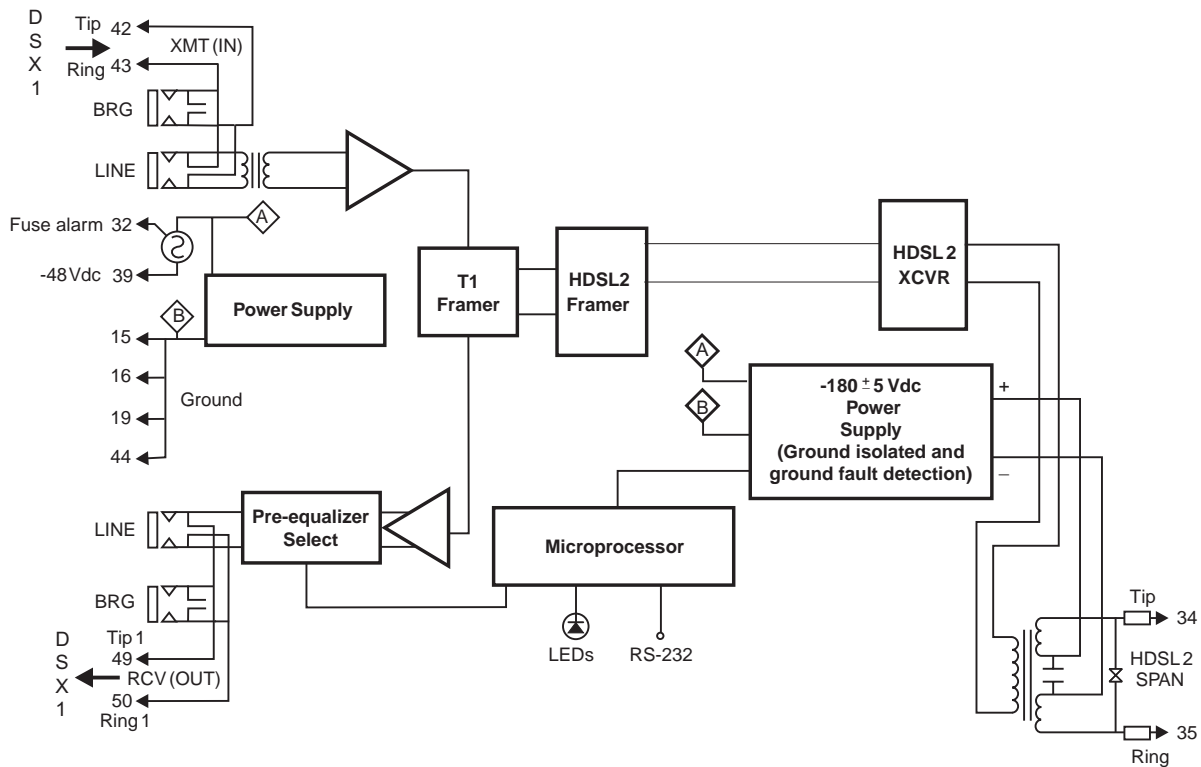

Figure 32. RS-232 Craft Port Pinouts

APPENDIX B - FUNCTIONAL OPERATION

ADC HDSL2 technology provides full-duplex services at standard DS1 rates over copper wires between an H2TU-C and an H2TU-R, which comprises one HiGain HDSL2 system. HiGain HDSL2 systems use ADC Overlapped Pulse Amplitude Modulation (PAM) Transmission with Interlocking Spectra (OPTIS) transceiver systems to establish full-duplex, 1.552 kbps data channels between the H2TU-C and a remotely located H2TU-R.

Figure 33 shows a block diagram of the H2TU-C. The H2TU-C receives a 1.544 Mbps DSX-1 data stream from the DSX-1 digital cross connect interface. The H2TU-C contains a DS1 frame synchronizer controlled by a 16-bit microprocessor that determines the type of framing on the DS1 stream and synchronizes to it. The H2TU-C recognizes Superframe (SF), including D4 or Extended Superframe (ESF) framing.



H0348-A

Figure 33. H2TU-C Block Diagram

TIMING

The low loop wander (0.3 UI max) of an H2TU-C, when used with compatible remote units, allows the circuit to be used in all critical timing applications, including transporting Stratum 1 timing.

GROUND FAULT DETECTION

The H2TU-C has a Ground Fault Detection (GFD) circuit which detects a ground or a resistive path to ground on any wire of the HDSL2 loop. This makes the product compliant with the Class A2 requirements of GR-1089.

APPENDIX C - COMPATIBILITY

The HiGain system uses HDSL2 transmission technology as recommended by ANSI committee in compliance with the ANSI T1.418-2000 HDSL2 standards. HiGain HDSL2 complies with GR-63-CORE, GR-499-CORE, and GR-1089-CORE.

The H2TU-C-231 List 7 is compatible with the following DS1 repeater shelves and associated equipment:

- HiGain Card Shelf HCS-417 (23" shelf)
- HCS-418 (19" shelf)
- HCS-402 (2-slot)
- AT&T 220 Office Repeater Bay (ORB)
- AT&T Small Cross-Section Shelf (SXSS)
- Kentrox 220 (The ALM option must be disabled (DIS) to resolve a conflict between the H2TU-C alarm relay output and the Kentrox external equalizer output. Both use pins 20 and 21.)
- Wescom® 342-30

APPENDIX D - PRODUCT SUPPORT

ADC Customer Service Group provides expert pre-sales and post-sales support and training for all its products. Technical support is available 24 hours a day, 7 days a week by contacting the ADC Technical Assistance Center.

Sales Assistance

800.366.3891 extension 73000
(USA and Canada)
952.917.3000
Fax: 952.917.3237

- Quotation Proposals
- Ordering and Delivery
- General Product Information

Systems Integration

800.366.3891, extension 73000
(USA and Canada)
952.917.3000

- Complete Solutions (from concept to installation)
- Network Design and Integration Testing
- System Turn-Up and Testing
- Network Monitoring (upstream or downstream)
- Power Monitoring and Remote Surveillance
- Service/Maintenance Agreements
- Systems Operation

ADC Technical Assistance Center

800.366.3891 ext. 73223
952.917.3223
Fax: 952.917.3244
Email: wsd_support@adc.com

- Technical Information
- System/Network Configuration
- Product Specification and Application
- Training (product-specific)
- Installation and Operation Assistance
- Troubleshooting and Repair/Field Assistance

Online Technical Support

- www.adc.com/technicalsupport

Online Technical Publications

- www.adc.com/documentationlibrary/technicalpublications

Product Return Department

800.366.3891 ext. 73748 or
952.917.3748
Fax: 952.917.3237
Email: repair&return@adc.com

- ADC Return Material Authorization (RMA) number and instructions must be obtained before returning products.

All telephone numbers with an 800 prefix are toll-free in the USA and Canada.

APPENDIX E - ABBREVIATIONS

A

ACO: Alarm Cutoff
ACQ: Acquisition
AIS: Alarm Indication Signal
ALRM: Alarm Condition
AMI: Alternate Mark Inversion
AOR: Addressable Office Repeater
AUTO: Auto-Framing Mode
AWG: American Wire Gauge

B

B8ZS: Bipolar with 8-Zero Substitution
BPV: Bipolar Violation
BPVT: Bipolar Violation Transparency

C

CLOC: Customer Local Loopback
CPE: Customer Premises Equipment

D

DBER: DS1 Bit Error Rate
DLC: Digital Loop Carrier
DSX-1: DS1 Cross-Connect Frame

E

EQL: Equalization
ESD: Electrostatic Discharge
ESF: Extended SuperFrame
EXZ: The occurrence of 8 consecutive zeroes for B8ZS or 16 for AMI

F

FERR: Framing Bit Error
FLDL: Flash Download

G

GFD: Ground Fault Detect

H

HBER: HDSL2 Block Error Rate
HCDS: High Capacity Digital Service
HG: HiGain

I

ILR: Intelligent Line Repeater
IOR: Intelligent Office Repeater
IR: Intelligent Repeater

L

LAIS: Line Alarm Indication Signal
LATT: Loop Attenuation
LED: Light Emitting Diode
LLOS: Local Loss of Signal
LOS: Loss of Signal
LOSW: Loss of Sync Word
LPDN: Loopdown
LPF: Line Power Feed
LRAI: Line RAI

M

M: HDSL4 Margin
MAL: Margin Alarm
MSEC: Monitored Seconds

N

NID: Network Interface Device
NLOC: Network Local Loopback
NREM: Network Remote Loopback

O

OPTIS: Overlapped PAM Transmission with Interlocking Spectra

P

PAM: Pulse Amplitude Modulation

PBOC: Power Back Off - Customer
PBON: Power Back Off - Network
PL: Payload
PRMF: Performance Report Messaging - Far End
PRMN: Performance Report Messaging - Near End

R

RAIS: Remote Alarm Indication Signal
RDA: Remote Disconnect Alarm
RLOS: Remote Loss of Signal
RRAI: Remote Alarm Indication

S

SF: SuperFrame
SMJK: SmartJack Loopback
SNET: Southern New England Telephone
SPLB: Special Loopback

T

TUC: Transmission Unit Central Office
TUR: Transmission Unit Remote End

U

UNFR: Unframed

CERTIFICATION AND WARRANTY

FCC CLASS A COMPLIANCE

This equipment has been tested and found to comply with the limits for a Class A digital device, pursuant to Part 15 of the FCC Rules. These limits are designed to provide reasonable protection against harmful interference when the equipment is operated in a commercial environment. This equipment generates, uses, and can radiate radio frequency energy and, if not installed and used in accordance with the instruction manual, may cause harmful interference to radio communications. Operation of this equipment in a residential area is likely to cause harmful interference in which case the user will be required to correct the interference at his own expense.

LIMITED WARRANTY

Product warranty is determined by your service agreement. Contact your sales representative or Customer Service for details.

SAFETY STANDARDS COMPLIANCE

This equipment has been tested and verified to comply with the applicable sections of the following safety standards:

- GR 63-CORE - Network Equipment-Building System (NEBS) Requirements
- GR 1089-CORE - Electromagnetic Compatibility and Electrical Safety
- Binational Standard, UL-60950/CSA-C22.2 No. 60950-00, Third Edition

For technical assistance, refer to [“Appendix D - Product Support”](#) on page 60.

ADC DSL Systems, Inc.

14402 Franklin Avenue
Tustin, CA 92780-7013

Tel: 714.832.9922

Fax: 714.832.9924

Technical Assistance

Tel: 800.366.3891 ext. 73223

Tel: 952.917.3223

Fax: 952.917.3244

DOCUMENT: LTPH-UM-1181-01



1250701