

# USER MANUAL

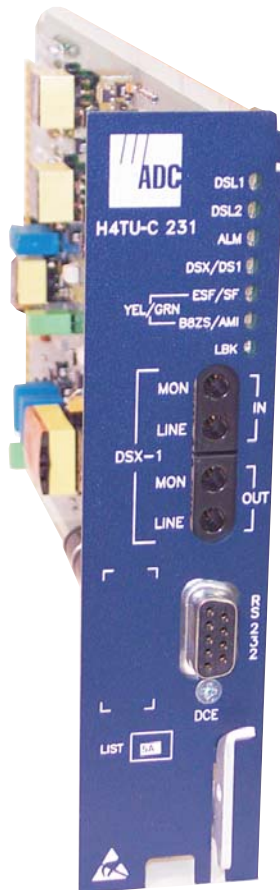

**HiGain H4TU-C-231 List 5A Line Unit**  
Product Catalog: H4TU-C-231-L5A  
CLEI: VACKMFKA



## Revision History of This Manual

To order copies of this manual, use document catalog number LTPH-UM-1253-01.

Issue	Release Date	Revisions Made
1	October 15, 2003	Initial release

## Copyright

October 15, 2003

© 2003 ADC Telecommunications, Inc. All rights reserved.

## Trademark Information

ADC is a registered trademark of ADC Telecommunications, Inc.

HiGain is a registered trademark of ADC DSL Systems, Inc. No right, license, or interest to such trademarks is granted hereunder, and you agree that no such right, license, or interest shall be asserted by you with respect to such trademark.

Other product names mentioned in this document are used for identification purposes only and may be trademarks or registered trademarks of their respective companies.

## Disclaimer of Liability

Information contained in this document is company private to ADC DSL Systems, Inc., and shall not be modified, used, copied, reproduced or disclosed in whole or in part without the written consent of ADC.

Contents herein are current as of the date of publication. ADC reserves the right to change the contents without prior notice. In no event shall ADC be liable for any damages resulting from loss of data, loss of use, or loss of profits, and ADC further disclaims any and all liability for indirect, incidental, special, consequential or other similar damages. This disclaimer of liability applies to all products, publications and services during and after the warranty period.

## USING THIS MANUAL

The following conventions are used in this manual:

- Monospace type indicates screen text.
- Keys you press are indicated by small icons such as **Y** or **ENTER**. Key combinations to be pressed simultaneously are indicated with a plus sign as follows: **CTRL** + **ESC**.
- Items you select are in **bold**.
- Three types of messages, identified by icons, appear in text.



**Notes contain information about special circumstances.**



**Cautions indicate the possibility of personal injury or equipment damage.**



**The Electrostatic Discharge (ESD) symbol indicates that a device or assembly is susceptible to damage from electrostatic discharge.**

For a list of abbreviations used in this document, refer to [“Appendix D - Abbreviations”](#) on page 60.

## INSPECTING SHIPMENT

Upon receipt of the equipment:

- Unpack each container and inspect the contents for signs of damage. If the equipment has been damaged in transit, immediately report the extent of damage to the transportation company and to ADC DSL Systems, Inc. Order replacement equipment, if necessary.
- Check the packing list to ensure complete and accurate shipment of each listed item. If the shipment is short or irregular, contact ADC DSL Systems, Inc. as described in [“Appendix C - Product Support”](#) on page 59. If you must store the equipment for a prolonged period, store the equipment in its original container.



# TABLE OF CONTENTS

<b>Overview</b> .....	<b>1</b>
Features .....	1
Applications .....	2
<b>Front Panel</b> .....	<b>3</b>
<b>Installation</b> .....	<b>6</b>
Verification .....	7
<b>Provisioning</b> .....	<b>8</b>
Accessing the Provisioning Screens .....	8
Connecting to a Maintenance Terminal.....	8
Logon Screen .....	8
Provisioning Tasks .....	11
Setting Date and Time .....	11
Setting Circuit ID Numbers .....	12
Configuring the System .....	13
Resetting to Factory Defaults .....	19
Clearing the History, Alarm, and Event Log Screens .....	20
<b>Monitoring System Activity and Performance</b> .....	<b>22</b>
Using the Monitor Screen to View System Activity.....	22
Using the Performance Screens to View Performance Data.....	24
Performance History at the DS1 Interface.....	24
Performance History at the HDSL4 Interface .....	27
Using the Performance Screens to View Alarm Data.....	30
Alarm History at the DS1 Interface .....	30
Alarm History at the HDSL4 Interface.....	33
Using the System Event Log to Track Events .....	34
Event Log Messages .....	35
Origin Tags .....	36
Using the Report Menu .....	37
<b>Testing</b> .....	<b>39</b>
System Alarms .....	39
Alarm Option for Digital Loop Carrier (DLC) Feed.....	40
Remote LOS and AIS Response.....	41
OCT55 Test Pattern with AMI Line Code.....	41
Loopback Operation.....	42
Generic Loopback Commands .....	43
A3LB and A5LB Loopback Commands .....	43

Loopback Test Procedures .....	44
General Troubleshooting Tips .....	44
Setting the Loopback Time-Out Option.....	44
GNLB Test Procedures .....	44
A3LB Test Procedures .....	47
A5LB Test Procedures .....	48
Loopback Testing Using a Maintenance Terminal .....	50
Loopback Testing Using Remote Unit Front-Panel Pushbuttons .....	50
Programmable DSX-1 Test Jacks .....	50
<b>Appendix A - Specifications</b> .....	<b>52</b>
Power Consumption .....	53
Maximum Power Dissipation .....	53
Maximum Current Drain .....	54
Loop Attenuation, Insertion Loss, and Reach .....	54
H4TU-C Card-Edge Connector.....	55
Fuse Alarm.....	55
.....	55
Craft Port .....	56
<b>Appendix B - Functional Operation</b> .....	<b>57</b>
Timing .....	57
Ground Fault Detection.....	57
Spectrum Issues.....	58
Compatibility .....	58
<b>Appendix C - Product Support</b> .....	<b>59</b>
<b>Appendix D - Abbreviations</b> .....	<b>60</b>
<b>Certification and Warranty</b> .....	<b>Inside Back Cover</b>

## LIST OF FIGURES

1. H4TU-C Front Panel .....	3
2. Installing an H4TU-C into a Shelf.....	6
3. Logon Screen.....	9
4. Config Menu - Date and Time.....	11
5. Inventory Screen.....	12
6. Config Menu.....	13
7. Config Menu - Standard Options (defaults shown).....	14
8. Config Menu - ADC Options (defaults shown) .....	14
9. Config Menu - Set Factory Defaults .....	19
10. Config Menu - Master Clear.....	21
11. Monitor Screen - Active Loopback with Alarms .....	22
12. H4TU-R DS1 31-Day Performance History .....	24
13. H4TU-C DS1 48-Hour Performance History .....	25
14. H4TU-R DS1 25-Hour Performance History .....	25
15. H4TU-R DS1 Current Statistics .....	26
16. H4TU-C DS1 Current Statistics .....	26
17. H4TU-C HDSL4 31-Day Performance History .....	28
18. H4TU-C HDSL4 48-Hour Performance History .....	28
19. H4TU-C HDSL4 25-Hour Performance History .....	29
20. H4TU-C HDSL4 Current Statistics.....	29
21. H4TU-C DS1 Alarm History Screen.....	31
22. H4TU-R DS1 Alarm History Screen.....	31
23. H4TU-C HDSL4 Alarm History Screen .....	33
24. System Event Log.....	34
25. Report Menu - Full Report .....	37
26. H4TU-R LOS and AIS Response Priorities .....	41
27. Loopback Summary.....	42
28. Loopback Modes .....	46
29. DSX-1 Testing Towards Customer .....	51
30. DSX-1 Testing Towards Network.....	51
31. DSX-1 Test Jack Screen .....	51
32. H4TU-C Card-Edge Connector.....	55
33. RS-232 Craft Port Pinouts .....	56
34. H4TU-C Block Diagram .....	57

## LIST OF TABLES

1. Front-Panel Description .....	4
2. LED Status and Functions .....	5
3. Navigational Keys for the Maintenance Terminal Screens .....	9
4. Logon Screen Menus .....	10
5. H4TU-C Standard Config Menu Options .....	15
6. H4TU-C ADC Config Menu Options.....	16
7. DS1 and DSX-1 24-Hour PM Threshold.....	18
8. Monitor Screen Descriptions .....	23
9. Error Acronyms Used on the DS1 Performance History Screens .....	27
10. Error Acronyms Used on the HDSL4 Performance History Screens.....	30
11. DS1 Alarm Descriptions .....	32
12. HDSL4 Alarm Descriptions.....	33
13. Event Log Entry Messages .....	35
14. Origin Tags .....	36
15. Report Types.....	38
16. System Alarms Displayed on Alarm History Screens .....	39
17. Summary of HDSL4 Generic Loopback Codes and Activation Methods.....	45
18. A3LB Addressable Repeater Loopback Commands .....	47
19. A5LB Addressable Repeater Loopback Commands .....	48
20. H4TU-C Power Parameters .....	53
21. HDSL4 Reach Chart .....	54



# OVERVIEW

The H4TU-C-231 List 5A (H4TU-C) line unit is the Central Office (CO) side of a T1 transmission system. The four-wire HDSL4 product family is based on the HDSL4 standard ANSI T1.418 Issue 2.

The H4TU-C, when used with an H4TU-R remote unit, transmits a 1.544 Mbps payload a maximum distance of 12 kft. over two unconditioned copper pairs. The H4TU-C supports three powered spans to further expand reach.

The H4TU-C is designed to mount in standard 220 mechanics shelves. For a list of compatible shelves, see [“Compatibility” on page 58](#).



**This line unit requires HiGain Management Unit (HMU) firmware version 3.2 or later (L9 or L7A) for full feature TL1 management.**

## FEATURES

Standard features include:

- HDSL4 transmission features
  - Lightning and power cross-protection on HDSL4 interfaces
  - Full-duplex HDSL4 transmission on four wire at 1.568 Mbps
  - Ultra-low wander (Stratum 1 compliant)
  - Loop reversal detection on HDSL4 loop
  - Spectrum compatibility with Asymmetric Digital Subscriber Line (ADSL) services
  - Doubler (H4D) support for up to three spans
  - Sources sealing current when connected to any locally powered H4TU-R
- Front-panel features
  - DSX-1 access jacks
  - Seven Status Light Emitting Diodes (LEDs) for system status reporting
  - RS-232 craft port for connection to a maintenance terminal
- Digital Data Service (DDS) latching loopback
- Maintenance screens to provision, monitor, and troubleshoot HDSL4 system
  - DS1 and HDSL4 performance monitoring
  - Loop attenuation and insertion loss reporting
  - Non-volatile storage of performance monitoring parameters
  - Performance Report Messaging (PRM) support for Supplemental PRM (SPRM) and Network PRM (NPRM) at the H4TU-R
  - Payload (PL) and HDSL Generic (HG) loopback source identification
  - Margin Alarm (MAL) threshold
  - Report menu option for downloading status and performance monitoring data to a file
  - Remote provisioning through TL1 FDL

- Fractional T1 (FT1) maintenance
- Configuration options
  - Selectable DSX-1 pre-equalizer
  - Bipolar Violation Transparency (BPVT) options
  - Bit Error Rate (BER) alarm
  - Power Back Off Network (PBON) and Power Back Off Customer (PBOC) options for configuring HDSL4 transmit power levels
  - Loss of Signal/Alarm Indication Signal (LOS/AIS) payload alarm
  - Remote provisioning
  - Concurrent detection of all loopback activation codes
- Additional Loopback Timeout (LBTO) settings of 8 hours and 24 hours



**DS1 is used throughout this document to refer to either the remote unit's DS1 interface or the line unit's DSX-1 interface.**

## APPLICATIONS

HDSL4 systems provide a cost-effective, easy-to-deploy method for delivering T1 High Capacity Digital Service (HCDS) over two pair of wires. HDSL4 systems support a multitude of network connections.

- The service is deployed over two unconditioned, non-loaded copper pairs at 784 kbps per loop.
- Conventional, inline DS1 repeaters are no longer required.
- Cable pair conditioning, pair separation, and bridged tap removal are not required.

For Span 1, each loop has no more than 47 dB of insertion loss (INSL) at 196 kHz, with driving and terminating impedances of 135Ω; for Span 2 and Span 3, each loop has no more than 43 dB of insertion loss at 196 kHz. In general, HDSL4 systems:

- Operate effectively in the same cable binder group with other HDSL4 lines, HDSL, T1, ADSL, SDSL, POTS, DDS, and other transmission schemes.
- Can be used with customers requiring DS1 service on a temporary or permanent basis.
- Provide a means of quickly deploying service in advance of fiber-optic transmission systems.

# FRONT PANEL

Figure 1 shows the H4TU-C front panel. Table 1 on page 4 describes the front-panel components. For pinout diagrams of the H4TU-C card-edge connector and craft port, refer to “Appendix A - Specifications” on page 52.

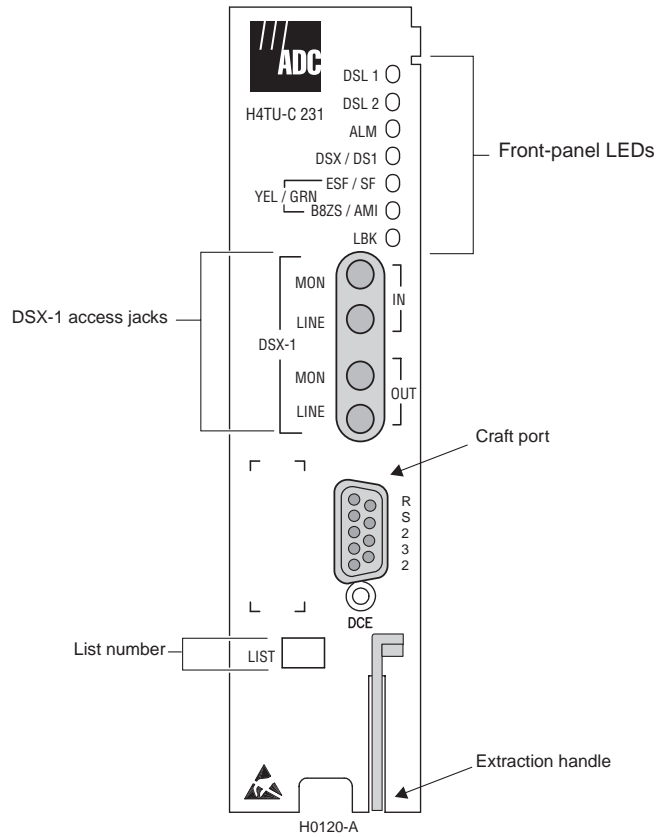

**Figure 1.** H4TU-C Front Panel

**Table 1. Front-Panel Description**

<b>Front-Panel Feature</b>	<b>Function</b>
List number	List number identifies the list number of the H4TU-C.
Front-panel LEDs	Display HDSL4 and DS1 Line, provisioning, and alarm status through front-panel LEDs. Refer to <a href="#">Table 2 on page 5</a> for a listing of the front-panel LEDs and their functions.
DSX-1 access jacks	
MON	Provides non-intrusive monitoring jack access to (IN) and from (OUT) the HDSL4 span at the DSX-1 interface. Allows the two DS1 payloads to be monitored.
LINE	Provides splitting jack access to (IN) and from (OUT) the HDSL4 span at the DSX-1 interface. Breaks the OUT and IN paths to permit test signal insertion and retrieval.
DB-9 craft port (RS-232 DCE connector)	Provides bidirectional communication between the unit and an external terminal to allow configuration and performance monitoring through the maintenance terminal screens.
CLEI and ECI bar code label	Provides the human-readable Common Language Equipment Identifier (CLEI) code number and the Equipment Catalog Item (ECI) bar code number.
Retaining latch	Retains the H4TU-C when in the upright position and releases the H4TU-C when depressed.

Table 2 lists the LED status and their functions. The H4TU-C reports the alarm type or loopback status on its front panel.

**Table 2. LED Status and Functions**

LED and Status	Function
<b>DSL1</b>	
Solid green	Loop 1 of the HDSL4 span connected to H4TU-C has synchronized without error.
Flashing red once every second	Loop 1 of the HDSL4 span connected to H4TU-C is in acquisition.
Solid red	Loop 1 of the HDSL4 span connected to H4TU-C has detected HBER, MARG alarm, or any Power Feed alarms.
<b>DSL2</b>	
Solid green	Loop 2 of the HDSL4 span connected to H4TU-C has synchronized without error.
Flashing red once every second	Loop 2 of the HDSL4 span connected to H4TU-C is in acquisition.
Solid red	Loop 2 of the HDSL4 span connected to H4TU-C has detected HBER, MARG alarm, or any Power Feed alarms.
<b>DSX/DS1</b>	
Solid green	DSX-1 signal at the H4TU-C is error-free.
Solid red	LLOS, BPV, frame error, or CRC is detected at H4TU-C. (LED updates once every second when error occurs.)
<b>ALM</b>	
OFF	DS1 signal is present at both the H4TU-R and H4TU-C.
Solid yellow	RLOS is present at the H4TU-R.
Solid red	LLOS is present at the H4TU-C.
<b>ESF/SF</b>	
OFF	Unframed DSX-1 is present at the H4TU-C or no DSX-1 is detected at the H4TU-C.
Solid yellow	ESF frame formatting is present at the H4TU-C.
Flashing yellow once every second	ESF frame formatting and frame error/CRC are present at the H4TU-C.
Solid green	SF frame formatting is present at the H4TU-C.
Flashing green once every second	SF frame formatting and frame error are present at the H4TU-C.
<b>B8ZS/AMI</b>	
OFF	No DSX-1 signal is present at the H4TU-C.
Solid yellow	B8ZS is provisioned at the H4TU-C.
Flashing yellow once every second	B8ZS and excess zeros string are present at the H4TU-C.
Solid green	AMI is provisioned at the H4TU-C.
Flashing green once every second	AMI and BPV are present at the H4TU-C.
<b>LBK</b>	
OFF	H4TU-C is not ARMED or in loopback.
Solid yellow	H4TU-C is in either NLOC or CREM (RLB).
Flashing yellow once every second	System is ARMED.

# INSTALLATION

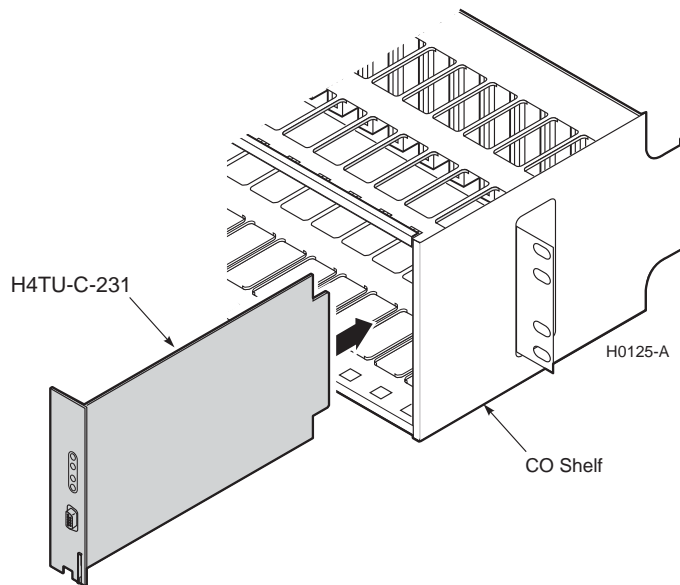

**Figure 2.** *Installing an H4TU-C into a Shelf*



Upon receipt of the equipment, inspect the contents for signs of damage. If the equipment has been damaged in transit, immediately report the extent of damage to the transportation company and to ADC.



When installing an H4TU-C in a chassis, be sure to wear an antistatic wrist strap. Avoid touching components on the circuit board.



To comply with the intrabuilding wiring requirements of GR-1089 CORE, Section 4.5.9, the shields of the ABAM-type cables that connect the H4TU-C DSX-1 output ports to the cross-connect panel must be grounded at both ends.

- 1 Align the H4TU-C with the enclosure slot guides, then push the unit in until it touches the backplane card-edge connector.
- 2 Place your thumbs on the H4TU-C front panel and push the H4TU-C firmly into the slot guides until the unit clicks into the backplane and is properly seated.

## VERIFICATION

Once the H4TU-C is installed, verify that it is operating properly. To do this, monitor the front-panel status LEDs.

- 1 Verify that as the H4TU-C powers up, it attempts to communicate with a remote unit as the DSL LED flashes red once every second. (Table 2 on page 5 lists the status messages.)
  - If the H4TU-C is unable to communicate with the H4TU-R, the DSL LED displays solid red, indicating HBER, MARG, or PWRF alarms.
  - If the H4TU-C is able to communicate with the H4TU-R, the DSL LED displays solid green, indicating that the HDSL4 spans are synchronized without error.
- 2 Verify the presence of a DS1 signal by confirming that the ALM LED is off (not lit). If the ALM LED displays red or yellow, a DS1 LOS condition exists. Refer to Table 2 on page 5 to locate the problem.
- 3 Verify error-free DS1 transmission by confirming that the DS1, framing (ESF/SF), and line code (B8ZS/AMI) LEDs display solid colors. Refer to Table 2 on page 5 to locate the problem if these LEDs are either flashing or display solid red.

# PROVISIONING

## ACCESSING THE PROVISIONING SCREENS

Use a maintenance terminal (ASCII terminal or a PC running terminal emulation software) connected to the H4TU-C craft port (or to an HMU craft port) to access the status, history, inventory, and provisioning screens (see [Figure 3 on page 9](#)).



**No dip switches or jumpers are required to provision the H4TU-C as it contains a non-volatile RAM (NVRAM) which stores the system option settings. System option settings are retained if shelf power is lost or the H4TU-C is unplugged.**

## Connecting to a Maintenance Terminal

The craft port on the front panel allows you to connect the H4TU-C to a maintenance terminal, such as an ASCII terminal or PC running a terminal emulation program. Once connected to a maintenance terminal, you can access the maintenance, provisioning, and performance screens.

To connect to a maintenance terminal:

- 1 Connect a standard 9-pin terminal cable to the RS-232 craft port on the H4TU-C front panel ([Figure 1 on page 3](#)).
- 2 Connect the other end of the cable to the serial port on the maintenance terminal.
- 3 Start a terminal emulation program such as Procomm (emulating a VT100 terminal).
- 4 Configure the maintenance terminal for the following communication settings:
  - 9600 baud
  - No parity
  - 8 data bits
  - 1 stop bit
  - Hardware flow control set to OFF
- 5 If necessary, press **CTRL** + **R** to refresh the HDSL4 logon screen.

## Logon Screen

The maintenance terminal screens allow you to monitor, provision, and troubleshoot an HDSL4 system.

To select a menu from the logon screen ([Figure 3 on page 9](#)), do one of the following:

- Press the underlined letter of the menu.
- Use **←** **→** to select the menu, then press **ENTER**.

[Table 3 on page 9](#) summarizes the navigational keys. They are also listed in the onscreen Help menu. [Table 4 on page 10](#) describes the logon screen menus.



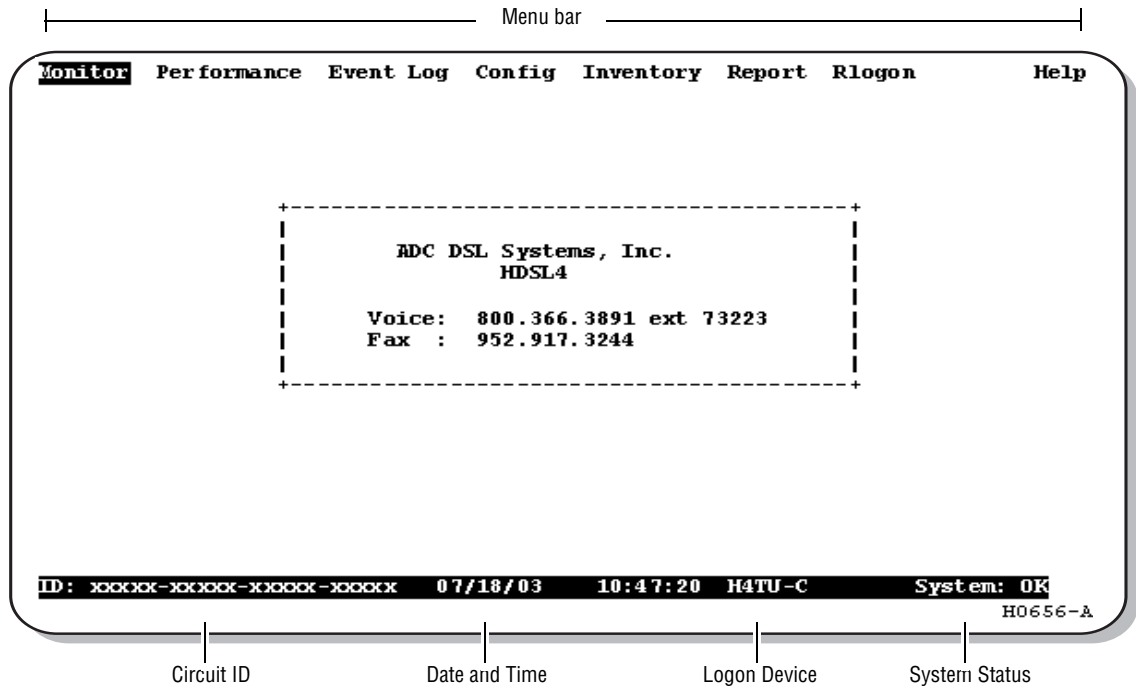

**Figure 3.** Logon Screen

**Table 3.** Navigational Keys for the Maintenance Terminal Screens

Key <sup>(a)</sup>	Function
<b>SPACEBAR</b>	Cycle through selections.
<b>ENTER</b>	Activate the current setting or choice, or display a menu.
<b>ESC</b> or <b>F11</b> (VT100 only)	Return to the parent menu.
<b>↑</b> or <b>CTRL + E</b>	Select the submenu or item above the current one, or return to the previous menu.
<b>↓</b> or <b>CTRL + X</b>	Select the submenu or item below the current one.
<b>→</b> or <b>CTRL + D</b>	Select the menu or item to the right of the current one.
<b>←</b> or <b>CTRL + S</b>	Select the menu or item to the left of the current one, or return to the previous menu.
<b>CTRL + R</b>	Refresh the screen.

(a) Legacy management units require use of control keys instead of arrow keys.



**Most VT100 emulation programs support a print screen option. For Windows-based programs, such as Procomm or HyperTerminal, see the Help menu for instructions.**

**Table 4.** Logon Screen Menus

<b>Press this key:</b>	<b>To access this menu:</b>	<b>Menu Functions</b>
<b>M</b>	Monitor	Monitors loopbacks and alarms, provides a graphical representation of circuit activity, including ES, UAS, SES, and line code.
<b>P</b>	Performance	Provides performance and alarm histories for current, 25-hour, 48-hour, or 31-day periods for either the DS1 or HDSL4 interface.
<b>E</b>	Event Log	Identifies the 100 most recent system events and reports the date and time of occurrence.
<b>C</b>	Config	Provides standard configuration options, ADC options, date and time setting, and a reset option (factory settings). Also provides a master clear option that clears all performance, alarm, and event log entries.
<b>I</b>	Inventory	Provides product information about the various devices that are in the system and lists circuit and device identifications.
<b>O</b>	Report	Provides four types of reports: Full Report, Short Report, System Information Report, and Event Report.
<b>R</b>	Rlogon/Rlogout	Remote logon can be performed from the H4TU-C or H4TU-R. The screen displays Rlogout when the H4TU-C or H4TU-R is remotely logged on to the other unit at the end of the circuit. To log off from the remote unit, press <b>R</b> . Rlogout changes to Rlogon. The unit is now locally logged on until <b>R</b> is pressed again to reinitiate the remote logon.
<b>H</b>	Help	Provides a glossary of terms used in the maintenance screens, a list of navigational keys, print guide, and ADC contact information.

## PROVISIONING TASKS

After the H4TU-C is successfully installed, perform these basic provisioning tasks:

- Set date and time (see “Setting Date and Time” on this page).
- Set circuit ID numbers (see “Setting Circuit ID Numbers” on page 12).
- Make any configuration changes (see “Configuring the System” on page 13).
- Clear history, alarm, and event log screens to remove miscellaneous data acquired during startup (see “Clearing the History, Alarm, and Event Log Screens” on page 20).

### Setting Date and Time

To set the date and time:

- 1 Press **C** to select the Config menu.
- 2 Use the **↑** and **↓** arrow keys to select **Date and Time**, then press **ENTER**.
- 3 Type the date in the format indicated (see Figure 4), then press **ENTER**.
- 4 Type the time in the format indicated (entering seconds is optional), then press **ENTER**.

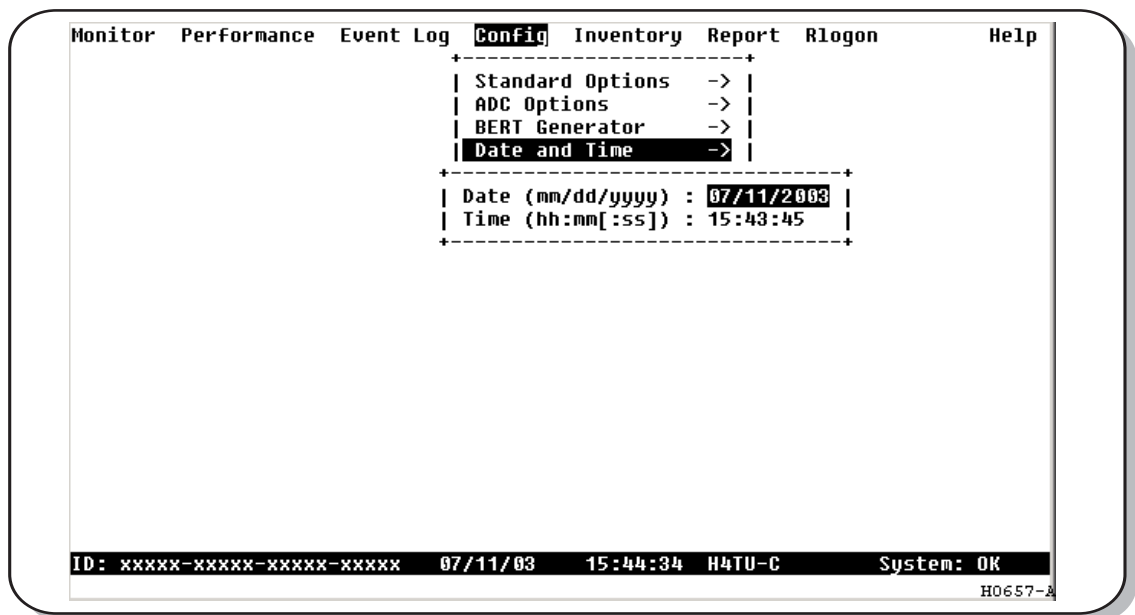

**Figure 4.** Config Menu - Date and Time

### Setting Circuit ID Numbers

The Inventory screen provides product information on all units in the system and allows setting of the circuit and unit identification numbers.

To set the circuit ID numbers:

- 1 Press **I** to select the Inventory screen.
- 2 Type the Circuit ID number in the field indicated (see [Figure 5](#)), then press **ENTER**.
- 3 Type the ID numbers of all other devices listed in the system, pressing **ENTER** after each entry.

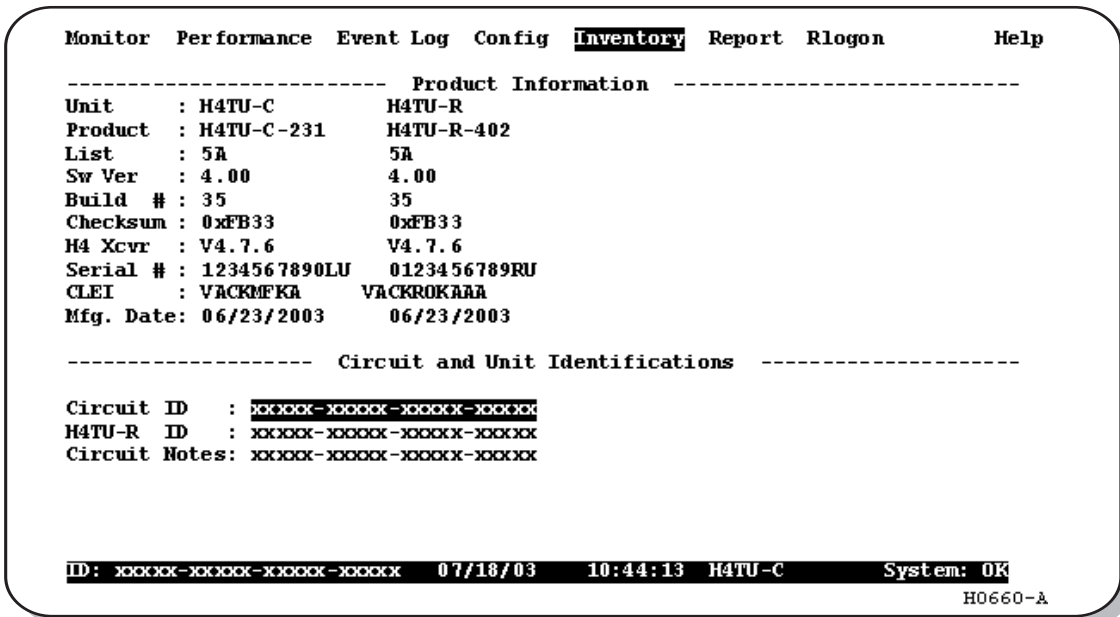
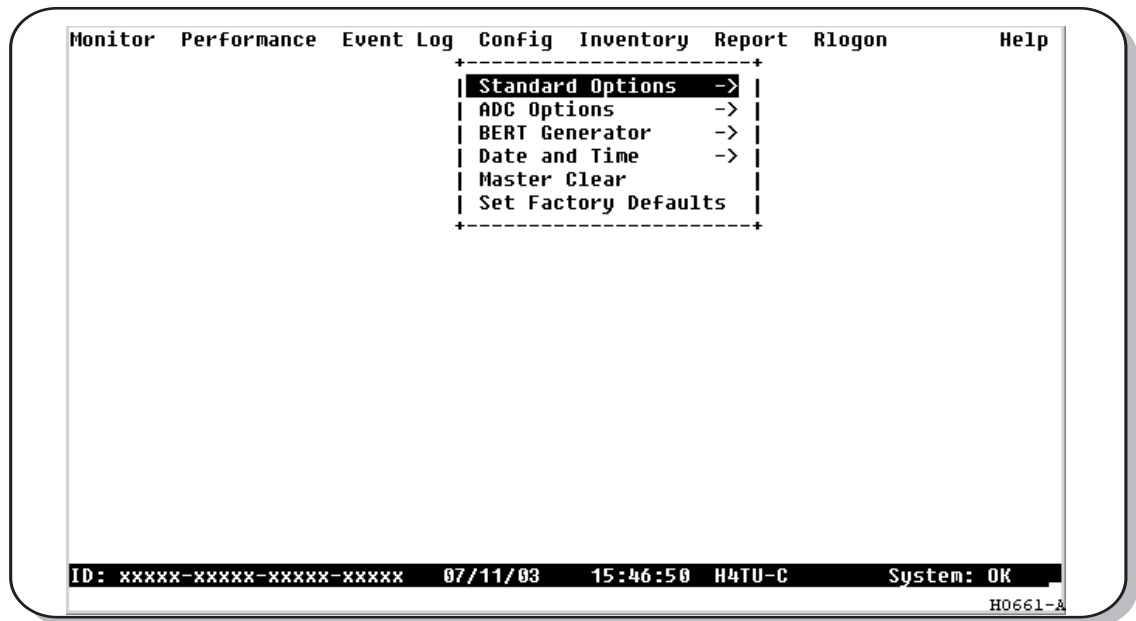

Figure 5. Inventory Screen

## Configuring the System

The Config menu (see [Figure 6](#)) allows you to make the following changes:

- Standard options (see [Figure 7](#) on page 14).
- ADC options (see [Figure 8](#) on page 14).
- Date and time (see “Setting Date and Time” on page 11).
- Master clear (see “Clearing the History, Alarm, and Event Log Screens” on page 20).
- Reset to factory default configuration (see “Resetting to Factory Defaults” on page 19).



*Figure 6. Config Menu*

### Making Changes to Standard and ADC Options

[Figure 7](#) on page 14 and [Figure 8](#) on page 14 show the Standard and ADC configuration options. Standard options are those supported by HiGain HD4SL4 units when connected to units from other vendors. ADC options are an extended set of options that are only available when using HiGain units exclusively.

[Table 5](#) on page 15 and [Table 6](#) on page 16 describe the Config menu options and the available settings for each option. The settings in bold type are the factory default settings.

To make changes to these options:

- 1 Press **C** to select the Config menu.
- 2 Use the **↑** and **↓** arrow keys to select **Standard Options** or **ADC Options**, then press **ENTER**.
- 3 Use the arrow keys to select an option.
- 4 Press the **SPACEBAR** to cycle through the settings for that option.
- 5 Press **ENTER** to activate your choice.

```

Monitor Performance Event Log Config Inventory Report Rlogon Help
+-----+
| Standard Options -> |
+-----+
| Loopback Timeout (LBT0) : 120 min |
| Loop Attenuation Threshold (LATT) [0-50]: 42 dB |
| Margin Threshold (MARG) [0-15]: 4 dB |
| DS1 Frame Formatting (FRMG) : ESF |
| DS1 Line coding (DSL) : B8ZS |
| H4TU-C Equalization (EQL) : EXT |
| H4TU-R Line Buildout (RLBO) : -7.5dB |
| Alarm Pattern (ALMP) : AIS |
| H4TU-R TLOS Loopback (TLOS) : DIS |
| Network Loopback Pattern (NLBP) : AIS |
| Power Back Off Network (PBON) : DEF |
| Power Back Off Customer (PBOC) : DEF |
+-----+

Use <Spacebar> to cycle through option settings and <Enter> to activate
ID: xxxxx-xxxxx-xxxxx-xxxxx 07/18/03 10:46:05 H4TU-C System: OK
H0662-A
    
```

Figure 7. Config Menu - Standard Options (defaults shown)

```

Monitor Performance Event Log Config Inventory Report Rlogon Help
+-----+
| Standard Options -> |
| ADC Options -> |
+-----+
| Line Power Feed (PWRP) : ON |
| Remote Provisioning (RTPV) : ENA |
| Bipolar Violation Transparency (BPVT) : DIS |
| DS1 BER (DBER) : DIS |
| HDSL4 BER Threshold (HBER) : DIS |
| Smartjack Loopback (LPBK) : ENA |
| Remote Disconnect Alarm (RDA) : DIS |
+-----+

Use <Spacebar> to cycle through option settings and <Enter> to activate
ID: xxxxx-xxxxx-xxxxx-xxxxx 07/15/03 14:38:17 H4TU-C System: OK
H0665-A
    
```

Figure 8. Config Menu - ADC Options (defaults shown)

**Table 5. H4TU-C Standard Config Menu Options**

<b>Standard Config Menu Options</b>	<b>Selection</b>	<b>Description</b>
Loopback Timeout (LBTO)	NONE	Disables automatic time-out cancellation of all loopbacks.
	20 min	Sets automatic cancellation of all loopbacks to 20 minutes after initiation.
	60 min	Sets automatic cancellation of all loopbacks to 60 minutes after initiation.
	<b>120 min</b>	Sets automatic cancellation of all loopbacks to 120 minutes after initiation.
	8 hr	Sets automatic cancellation of all loopbacks to 8 hours after initiation.
	24 hr	Sets automatic cancellation of all loopbacks to 24 hours after initiation.
Loop Attenuation Threshold (LATT)	0 through 50 dB	Determines the maximum loop attenuation before an alarm is declared. Zero disables the alarm. The loop attenuation threshold can only be set through the maintenance screens.
	<b>42 dB</b>	Default value.
Margin Threshold (MARG)	0 to 15 dB	Determines the minimum allowable margin below which a system alarm can occur. Zero disables the alarm. The Margin (Alarm) Threshold can only be set through the maintenance screens.
	<b>4 dB</b>	Default value.
DS1 Frame Formatting (FRMG)	AUTO	Configures the HDSL4 system to operate in an auto-framing (AUTO) mode in which it continuously searches the input DS1 bit stream for a valid SF or ESF frame pattern. Both line and path performance parameters are maintained. Unframed payloads will cause the ES-P and SES-P counters to increment.
	SF	Configures the HiGain HDSL4 system to search for the SF framing pattern at its DS1 input.
	<b>ESF</b>	Configures the HiGain HDSL4 system to search for the ESF framing pattern at its DS1 input.
	UNFR	Configures the HDSL4 system to operate in an unframed mode. This mode disables the auto framing process and forces the system to function as a transparent bit pipe. Only line parameters are considered when monitoring DS1 performance.
DS1 Line Coding (DS1)	<b>B8ZS</b>	Places both the H4TU-C and H4TU-R into their B8ZS modes.
	AMI	Places both the H4TU-C and H4TU-R into their AMI modes.
H4TU-C Equalization See "H4TU-C Equalization (EQL) Option." on page 17	<b>EXT</b>	Disable the HDSL4 internal equalizer, allowing connection of external equalizer hardware.
	0 ft	Sets the equalizer to DSX-1 for 0 to 132 feet.
	133 ft	Sets the equalizer to DSX-1 for 133 to 265 feet.
	266 ft	Sets the equalizer to DSX-1 for 266 to 398 feet.
	399 ft	Sets the equalizer to DSX-1 for 399 to 532 feet.
	533 ft	Sets the equalizer to DSX-1 for 533 to 655 feet.
H4TU-R Line Buildout (RLBO)		Sets the DS1 receive level output toward the Customer Interface (CI). H4TU-R Line Buildout can only be set through the maintenance screens.
	0 dB	Sets the DS1 RLBO level toward the CI to 0 dB.
	<b>-7.5 dB</b>	Sets the DS1 RLBO receive level toward the CI to -7.5 dB.
	-15.0 dB	Sets the DS1 RLBO receive level toward the CI to -15.0 dB.
Alarm Pattern (ALMP) See "Alarm Pattern (ALMP) Option." on page 17.	<b>AIS</b>	Enables the HDSL4 system to output an AIS payload at its DS1 ports for LOSW and DS1 LOS. For priority resolution, see <a href="#">Figure 26 on page 41</a> .
	LOS	Enables the HDSL4 system to output an LOS condition at its DS1 ports for LOSW and DS1 LOS.
H4TU-R TLOS Loopback (TLOS)	ENA	Enables a logic loopback at the H4TU-R when an LOS occurs at its DS1 input, if enabled at the H4TU-R. For priority resolution, see <a href="#">Figure 26 on page 41</a> .
	<b>DIS</b>	Disables Transmit Loss of Signal (TLOS) logic loopback.

*Continued*

**Table 5. H4TU-C Standard Config Menu Options (Continued)**

Standard Config Menu Options	Selection	Description
Network Loopback Pattern (NLBP)	<b>AIS</b>	Enables the H4TU-R to transmit an AIS toward CI for any network loopback. For priority resolution, see <a href="#">Figure 26 on page 41</a> .
	LOS	Enables the H4TU-R to transmit an LOS toward CI for any network loopback.
Power Back Off - Network (PBON) See “Power Back Off Customer (PBOC) and Power Back Off Network (PBON) Options” on page 17.	<b>DEF</b>	Configures the power output levels of the H4TU-C network unit toward the customer to comply with the Default template as defined in Section 6.1.4.2 of ANSI T1.418.
	ENH	Configures the power output levels of the H4TU-C network unit toward the customer to comply with the Enhanced template as defined in Section 6.1.4.2 of ANSI T1.418.
Power Back Off - Customer (PBOC) See “Power Back Off Customer (PBOC) and Power Back Off Network (PBON) Options” on page 17.	<b>DEF</b>	Configures the power output levels of the H4TU-R customer unit toward the network to comply with the Default template as defined in Section 6.1.4.2 of ANSI T1.418.
	ENH	Configures the power output levels of the H4TU-R customer unit toward the network to comply with the Enhanced template as defined in Section 6.1.4.2 of ANSI T1.418.

**Table 6. H4TU-C ADC Config Menu Options**

ADC Config Menu Options	Selection	Description
Line Power Feed (PWRF)	OFF	Disables powering to the HDSL4 pair.
	<b>ON</b>	Enables HDSL4 line power. <b>When ON, the output voltage is set at -185V.</b>
Remote Provisioning (RTPV)	<b>ENA</b>	Enables provisioning at the H4TU-R remote unit
	DIS	Disables provisioning at the H4TU-R remote unit
Bipolar Violation Transparency (BPVT) See “Bipolar Violation Transparency (BPVT) Option” on page 17.	ENA	Enables HDSL4 CRC and BPV errors at the DS1 input to be converted into DS1 BPVs at the DS1 output at the distant end. This makes HDSL4 transparent to BPVs.
	<b>DIS</b>	Disables BPV Transparency.
DS1 BER (DBER) See “DS1 BER (DBER) Option” on page 18.	ENA	1E-3, 1E-4, 1E-5, 1E-6, 1E-7, 1E-8, or 1E-9 = alarm activates when the DSX-1 BER alarm threshold exceeds the selected threshold.
	<b>DIS</b>	Prevents the generation of a system alarm due to DS1 BER.
HDSL4 BER Threshold (HBER) See “HDSL4 BER Threshold (HBER) Option” on page 18.	1E-6	Front-panel alarm is displayed and the Status LED flashes red when the Block Error Rate (BER) threshold exceeds $10^{-6}$ . BER is based on the definition of Bit Error Rate.
	1E-7	Front-panel alarm is displayed and the Status LED flashes red when the Block Error Rate (BER) threshold exceeds $10^{-7}$ .
	1E-8	Front-panel alarm is displayed and the Status LED flashes red when the Block Error Rate (BER) threshold exceeds $10^{-8}$ .
	1E-9	Front-panel alarm is displayed and the Status LED flashes red when the Block Error Rate (BER) threshold exceeds $10^{-9}$ .
	<b>DIS</b>	Prevents generation of a system alarm due to BER.
SmartJack Loopback (LPBK)	<b>ENA</b>	Enables the HDSL4 system to recognize all inband SmartJack (SMJK) loopback commands.
	DIS	Configures the HDSL4 system to ignore all inband SmartJack loopback commands.

*Continued*



**Table 6.** H4TU-C ADC Config Menu Options (Continued)

ADC Config Menu Options	Selection	Description
Remote Disconnect Alarm (RDA)	ENA	Enables a remote DS1 LOS condition at the input to the H4TU-R to generate an LOS alarm. AIS or LOS (depending on ALMP) is sent towards the network.
	DIS	Prevents a remote DS1 LOS condition at the input to the H4TU-R from causing an LOS alarm. The front-panel Status LED still flashes red and the ALRM RLOS message is displayed, but the alarm relay contacts do not close and LOS is sent towards the network from the H4TU-C instead of AIS.

**H4TU-C Equalization (EQL) Option.** The equalizer shapes the DS1 output signal of the H4TU-C to conform to a very specific pulse template when it arrives at the DSX-1 cross-connect point. The degree of pulse-shaping required is a function of the distance between the H4TU-C equipment bay and the DSX-1 panel. Thus, the equalizer has six discrete settings, in increments of 133 feet to cause the maximized separation of 655 feet.

**Alarm Pattern (ALMP) Option.** To improve HiGain HDSL4 compatibility with the switch-to-protect features used in Digital Loop Carrier (DLC) feeder applications, the H4TU-C has an Alarm Pattern (ALMP) option that allows you to select either an AIS or LOS DS1 output payload for the following alarms:

- LOSW on any loop
- LOS DS1

**Power Back Off Customer (PBOC) and Power Back Off Network (PBON) Options.** Power Back Off Customer (PBOC) and Power Back Off Network (PBON) allow the HDSL circuit to support two transmit power templates: default (DEF/higher level) and enhanced (ENH/lower level). These are defined in Section 6.1.4.2 of the ANSI T1E1.4 HDSL2 standard. Each HDSL4 receiver detects the level it is receiving during the start-up, pre-activation sequence. It then compares this level to the level it should be receiving according to the PBOC and PBON option settings (DEF or ENH). If the received level is outside the template limits, the receiver sends a message to the upstream HDSL4 transmitter requesting the proper level. These levels are adjusted only during the start-up routine or if the PBOC or PBON option settings are changed during normal operation. Since the ENH template levels are up to 15 dBm below those of the DEF template, the ENH setting can be used to reduce crosstalk levels into adjacent circuits. (For example, if crosstalk noise is being induced by the H4TU-R, set the PBOC option to its lower (ENH) level setting. Conversely, if the HDSL4 signal at the H4TU-R is being affected by crosstalk noise induced from adjacent pairs, set the PBOC option to its higher (DEF) level setting.



**Changing these Power Back Off option settings on a live circuit causes the HDSL4 loop to momentarily drop and then reacquire synchronization. This setting can also affect the operating margins.**

**Bipolar Violation Transparency (BPVT) Option.** The H4TU-C improves compatibility with Digital Loop Carrier (DLC) feeder applications because of its ability to transmit DS1 BPV occurrences between its DS1 interfaces. This feature is required to support protection switching in DLC applications. Each DLC terminal must be able to monitor the integrity of its Receive DS1 payload and then switch to the protect line when the integrity of the path drops below specific user selected limits. An essential requirement of this feature is the need for each DLC terminal to detect BPVs in its DS1 input. Standard HDSL systems correct DS1 BPVs at the input and, therefore, prevent them from being detected by the DLC terminals to which they are connected. The H4TU-C and its associated remote units remove this limitation and become BPV transparent by detecting and counting input BPVs at each end and then by replicating them at the DS1 output port of the distant end.

The BPV count is converted into BPVs at the distant end during the following second at a rate of 1 BPV every 128 DS1 bits up to a maximum of 12000 ( $BER = 7.7 \times 10^{-3}$ ). This maximum rate is more than adequate since it exceeds the maximum  $10^{-3}$  BER required by most DLC systems.

**DS1 BER (DBER) Option.** The DS1 BER alarm occurs when any of the DS1 or DSX-1 performance monitoring parameters listed in Table 7 exceed the counts shown for the 24-hour period between 12:00:00 AM through 11:59:59 PM. These thresholds correspond to a  $10^{-6}$  BER. All PM counters clear to zero at 12:00:00 AM or when Master Clear is selected.

*Table 7. DS1 and DSX-1 24-Hour PM Threshold*

Parameter	Threshold Count
CV-L (BPV)	133,400
ES-L, ES-P, PRM, PDVS-L	648
SES-L, SES-P	100
UAS-P, UAS-L	10

**HDSL4 BER Threshold (HBER) Option.** The HBER option permits the monitoring of loop integrity and reporting of alarms when excessive errors are detected. The PM primitive used for this purpose is the CRC checksum performed on the HDSL4 frame for both directions of transmission. It is, therefore, called a block error rate rather than the bit error rate associated with the DS1 interface. The CRC errors and counts are displayed on the Monitor screen for both the H4TU-C and H4TU-R. The HBER option allows an alarm to be generated if the total number of CRCs at either the H4TU-C or H4TU-R exceeds the selected BER threshold during the last 1-minute interval.

- HBER option = 1E-6. Alarm is generated if CRC > 93
- HBER option = 1E-7. Alarm is generated if CRC > 9

Once initiated, the HBER count clears when the CRC count drops below the selected threshold. Selecting NONE inhibits this alarm.

## Resetting to Factory Defaults

To reset the H4TU-C to its original factory defaults:

- 1 Press **C** to select the Config menu.
- 2 Use the **↑** and **↓** arrow keys to select **Set Factory Defaults** (see Figure 9), then press **ENTER**.
- 3 Press **Y** to reset the H4TU-C or press **N** to cancel this action.



Resetting the H4TU-C to its original factory settings may cause interruption of service.

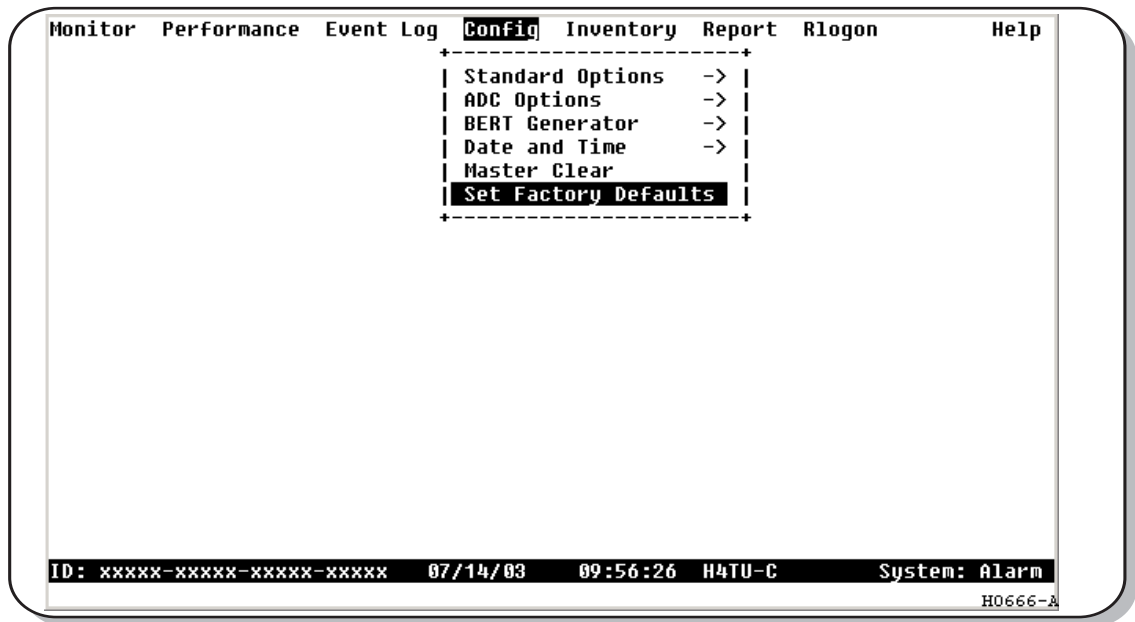

Figure 9. Config Menu - Set Factory Defaults

## Clearing the History, Alarm, and Event Log Screens

Select Master Clear to clear the History, Alarm, and Event Log screens after the system has been installed and is functioning properly. This removes miscellaneous data acquired during the start-up session and ensures that you have meaningful data thereafter.

To clear the Event Log, press **E** to select the Event Log screen, then press **L** to clear the screen.

To clear an individual history or alarm screen, do the following:

- 1 Press **P** to select the Performance screen.
- 2 Press the **SPACEBAR** to select either interface (**H4TU-C DS1**, **H4TU-R DS1**, **H4TU-C HDSL**, **H4DU-1 NET HDSL**, **H4DU-1 CPE HDSL**, **H4DU-2 NET HDSL**, **H4DU-2 CPE HDSL**, or **H4TU-R HDSL**), then press **ENTER**.
- 3 Press **↓** to select statistics.
- 4 Press the **SPACEBAR** to select the type of statistics (**Current**, **Alarm History**, **25-Hour History**, **48-Hour History**, or **31-Day History**), and press **ENTER** after your selection.
  - Selecting **31-Day History** allows you to clear the current, 25-hour, 48-hour, and 31-day performance history screens for the selected interface.
  - Selecting **Alarm History** allows you to clear the alarm history screen for the selected interface. For information about the DS1 and HDSL4 Alarm screens, see [Table 11 on page 32](#) and [Table 12 on page 33](#), respectively.
- 5 Press **L** to clear the screen.
- 6 Press **Y** to confirm.

To clear ALL history, alarm, and event log screens by this method:

- 1 Press **C** to select the Config screen.
- 2 Use the **↑** and **↓** arrow keys to select **Master Clear** (see [Figure 10](#)).
- 3 Press **ENTER** to activate.
- 4 Press **Y** to clear all screens.

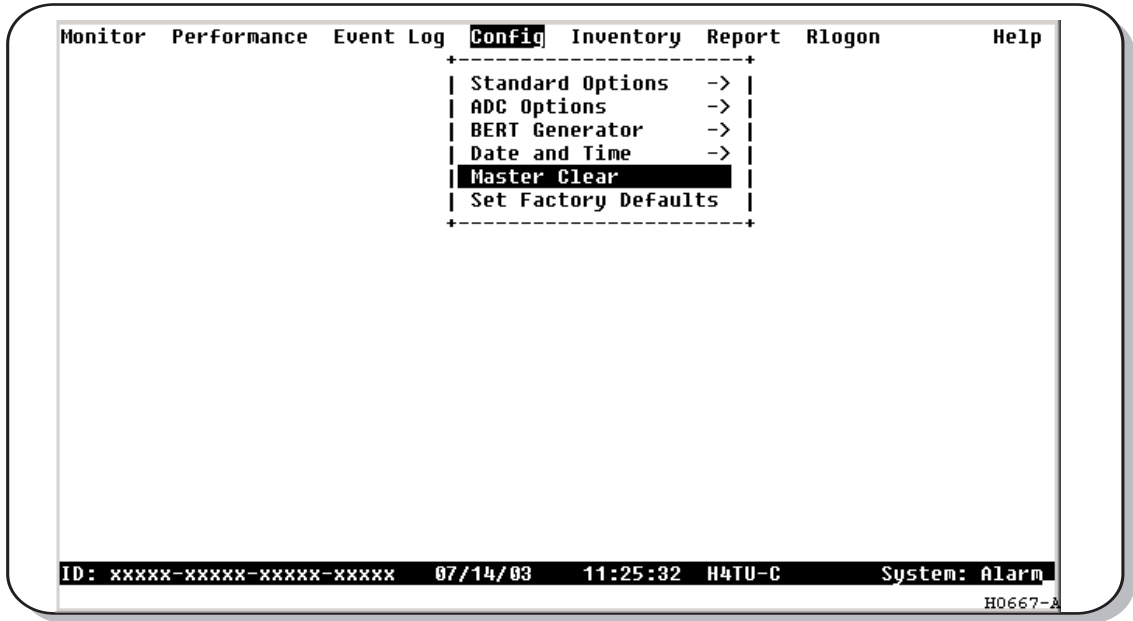

Figure 10. Config Menu - Master Clear

# MONITORING SYSTEM ACTIVITY AND PERFORMANCE

The HDSL4 system provides the following maintenance screens for monitoring system activity and assessing performance.

- The Monitor screen provides a graphical representation of circuit activity and allow initiation of loopbacks.
- The Performance screens provide current, 25-hour, 48-hour, and 31-day performance histories and a continuous alarm history.
- The Event Log provides a description of the 100 most recent events, which include their origin, time and date of occurrence, and message.

## USING THE MONITOR SCREEN TO VIEW SYSTEM ACTIVITY

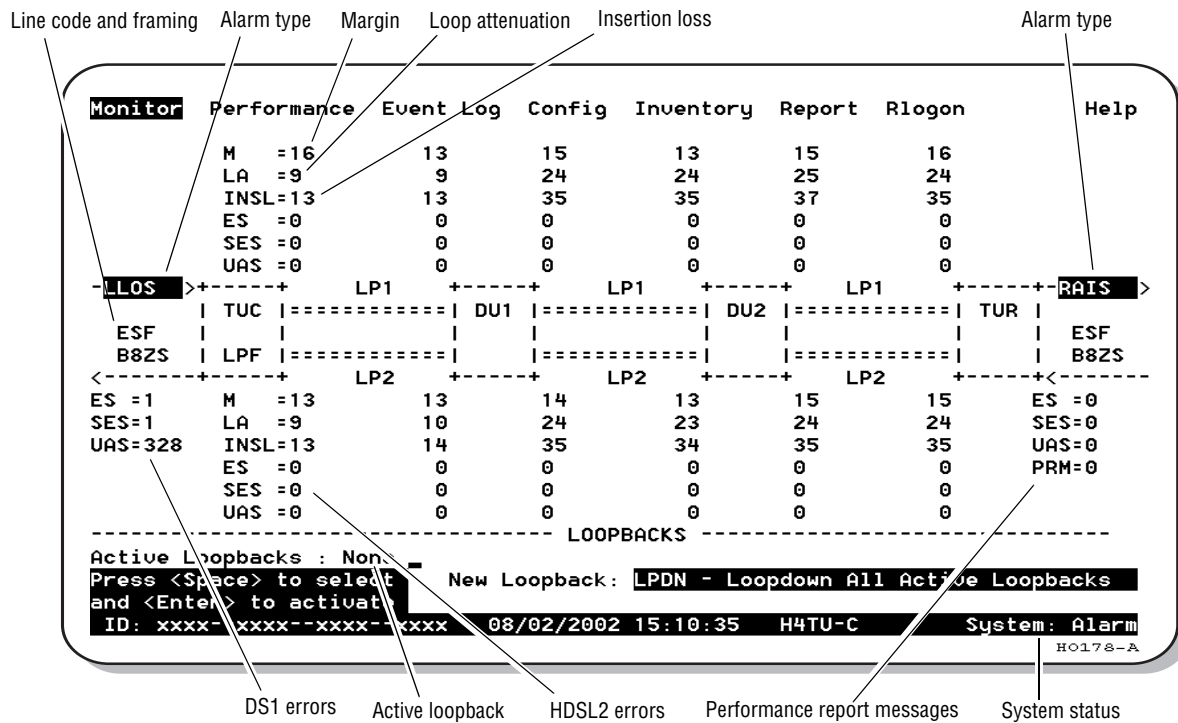

Figure 11. Monitor Screen - Active Loopback with Alarms

- 1 Press **M** to view the system diagram.  
 Figure 11 shows an armed circuit with an active loopback and alarms. Terms used on the system diagram are defined in the onscreen Help menu glossary. Abnormal situations are highlighted on the diagram. Table 8 on page 23 describes the screen fields.
- 2 To initiate a loopback, press **SPACEBAR** to cycle through the loopback choices. Press **ENTER** to make your choice.

When prompted with the message: Are you sure (Y/N)?, press **Y** to initiate the loopback or **N** to cancel. For more information about loopbacks, see "Testing" beginning on page 39.

- 3 To initiate a loopdown of all active loopbacks, press **SPACEBAR** to select **LPDN**, then press **ENTER**. When prompted with the message: Are you sure (Y/N)?, press **Y** to initiate the loopdown or **N** to cancel.

**Table 8. Monitor Screen Descriptions**

Field	Description
Active Loopback	An active loopback is indicated on the lower third of the Monitor screen. Available loopbacks are indicated by gray text. See <a href="#">Table 17 on page 45</a> for a summary of the HDSL4 generic loopback codes and activation methods.
Alarm Type	Indicates type of alarm.
Code Type	Type of DS1 line coding received or sent (B8ZS or AMI).
DS1 ES Count	Errored Seconds—The sum of the Errored Seconds-Line (ES-L) and Errored Seconds-Path (ES-P) counts detected on the DS1 input over a 24-hour period. Errors include DS1 frame errors, BPV, and ESF CRC errors.
DS1 SES Count	Severely Errored Seconds—The sum of the DS1 Severely Errored Seconds-Line (SES-L) and Severely Errored Seconds-Path (SES-P) counts over the last 24 hours.
DS1 UAS Count	Unavailable Seconds—The number of seconds during which the DS1 input signal was absent over a 24-hour period.
Frame Type	Type of DS1 framing detected at the input stream (SF, ESF, or UNFR).
HDSL4 ES Count	Errored Seconds—The number of 1-second intervals that contained at least one CRC or LOSW error. This value is a running total of the last 24 Hours.
HDSL4 SES Count	Severely Errored Seconds—The number of 1-second intervals that contain at least 50 CRC errors or one or more LOSW defects. An LOSW defect occurs when at least three consecutive HDSL frames contain one or more frame bit errors. This value is a running total of the last 24-hours.
HDSL4 UAS Count	Unavailable Seconds—The number of seconds the HDSL4 loop is unavailable. This occurs after 10 contiguous HDSL SES and is retired after 10 contiguous non-SES seconds. This value is a running total of the last 24 hours.
HG or (PL)	HG displays when the loopback was initiated from a HiGain (HG) front panel or by a maintenance terminal loopback command. PL displays when the loopback was initiated by a command embedded in the DS1 data path payload (PL).
ID	Circuit identification number.
INSL	Insertion Loss—The signal loss value for a 196 kHz signal over the cable.
LA	Loop Attenuation—Indicates the attenuation of the Overlapped Pulse Amplitude Modulation Transmission with Interlocking Spectra (OPTIS) pulse from the distant end. The value is related to insertion loss at 196 kHz and should be kept under 32 dB. This value differs from the insertion loss value of a conventional 196 kHz signal.
LPF	Line Power Feed—Indicates the HDSL4 line power is on.
M	Margin—The signal-to-noise ratio at all HDSL4 ports, relative to a 10 <sup>-7</sup> Bit Error Rate.
MAL	Margin Alarm—Indicates the margin on HDSL4 loop has dropped below the threshold (0 to 15 dB) set by the operator.
PRM	The sum of the Performance Report Messaging - Near End (PRM-NE) and Performance Report Messaging - Far End (PRM-FE) counts.
System Status	The presence or absence of an alarm condition is indicated on the lower right corner of all screens. <b>System: OK</b> indicates that there are no alarms present; <b>System: Alarm</b> indicates the presence of an alarm. Refer to <a href="#">“Using the Performance Screens to View Alarm Data” on page 30</a> .

## USING THE PERFORMANCE SCREENS TO VIEW PERFORMANCE DATA

The Performance screens display:

- CRC statistics for the HDSL4 or DS1 interface in 31-day, 48-hour, 25-hour, and current history reports.
- Alarm statistics for the DS1 interfaces (Figure 21 on page 31 and Figure 22 on page 31) or HDSL4 interfaces (Figure 23 on page 33) on a continuous basis.

To access the Performance history screens:

- 1 Press **P** to select the Performance screen.
- 2 Press **SPACEBAR** to select either interface (**H4TU-C DS1**, **H4TU-R DS1**, **H4TU-C HDSL**, **H4DU-1 NET HDSL**, **H4DU-1 CPE HDSL**, **H4DU-2 NET HDSL**, **H4DU-2 CPE HDSL**, or **H4TU-R HDSL**), then press **ENTER**.
- 3 Press **SPACEBAR** to select the type of statistics (**Current**, **Alarm History**, **25-Hour History**, **48-Hour History**, or **31-Day History**), then press **ENTER**.

### Performance History at the DS1 Interface

The Performance History for the DS1 Interface provides a 31-day, 48-hour, 25-hour, and current statistics screens for the H4TU-C and H4TU-R (as viewed from the H4TU-C). To gain access to the Blockage Indicator History screen, you must be logged on remotely. See “Using the Performance Screens to View Performance Data” on this page for logon procedures.

Figure 12 below and Figure 14 on page 25 are examples of DS1 performance history screens at the remote unit. Figure 13 on page 25 is an example of DS1 performance history screen at the line unit. Refer to Table 9 on page 27 for descriptions of the errors reported on DS1 interface screens. Asterisks indicate performance monitoring from the previous day.

Figure 15 on page 26 and Figure 16 on page 26 show statistics for the DS1 interface at the remote unit and line unit, respectively. These screens report 1-day, 1-hour, and 15-minute statistics.

```

Monitor  Performance  Event Log  Config  Inventory  Report  Rlogon  Help
-----
                H4TU-R DS1  31-Day History (Page 1 of 3)
-----
  Date      CU-L  ES-L  SES-L  UAS-L  PDUS-L  ES-P  SES-P  UAS-P  PRM-NE  PRM-FE
-----
  06/19      -    -    -    -    -    -    -    -    -    -
  06/20      -    -    -    -    -    -    -    -    -    -
  06/21      -    -    -    -    -    -    -    -    -    -
  06/22      -    -    -    -    -    -    -    -    -    -
  06/23      -    -    -    -    -    -    -    -    -    -
  06/24      -    -    -    -    -    -    -    -    -    -
  06/25      -    -    -    -    -    -    -    -    -    -
  06/26      -    -    -    -    -    -    -    -    -    -
  06/27      -    -    -    -    -    -    -    -    -    -
  06/28      -    -    -    -    -    -    -    -    -    -
  06/29      -    -    -    -    -    -    -    -    -    -
  06/30      -    -    -    -    -    -    -    -    -    -

-----
                Press: (N)ext Page, (P)revious Page, C(1)ear History
-----
Use <Space> to cycle through  Interface : H4TU-R DS1
choices and <Enter> to view  Statistics : 31-Day History
ID: xxxx-xxxx-xxxx-xxxx-xxxx 07/19/2002 11:55:45 H4TU-C System: Alarm
                                         H0179-A
  
```

Figure 12. H4TU-R DS1 31-Day Performance History



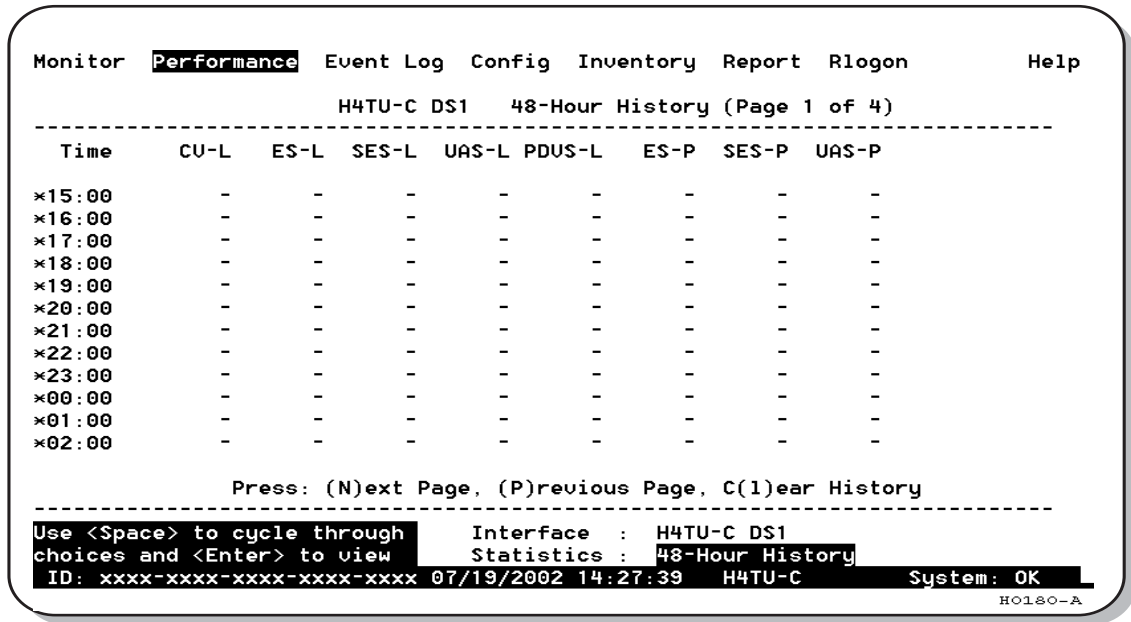

Figure 13. H4TU-C DS1 48-Hour Performance History

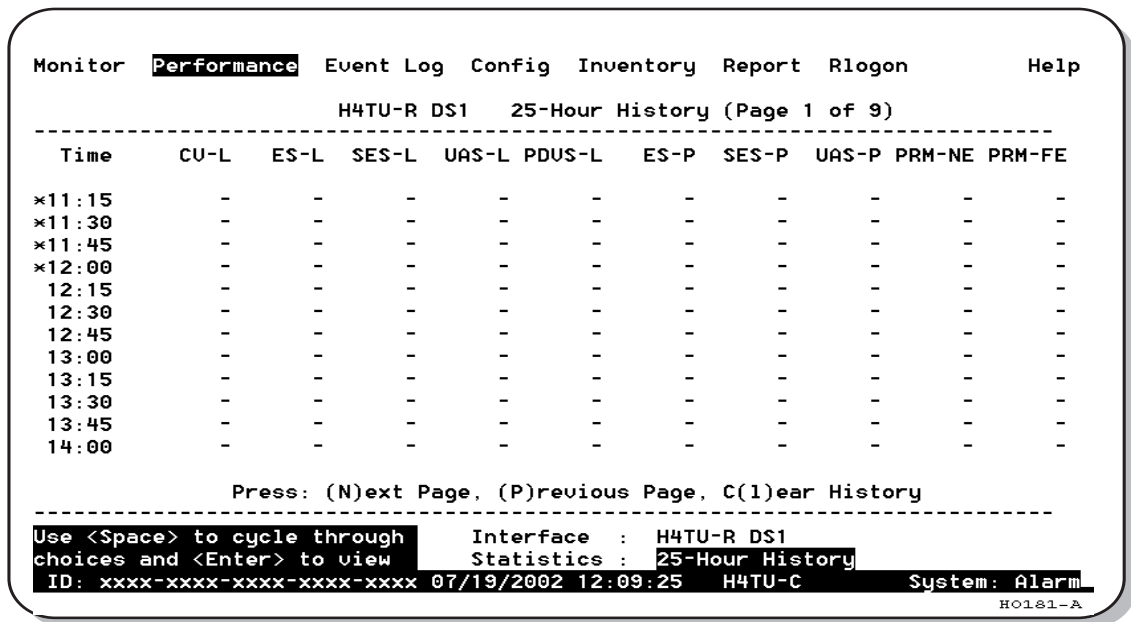

Figure 14. H4TU-R DS1 25-Hour Performance History

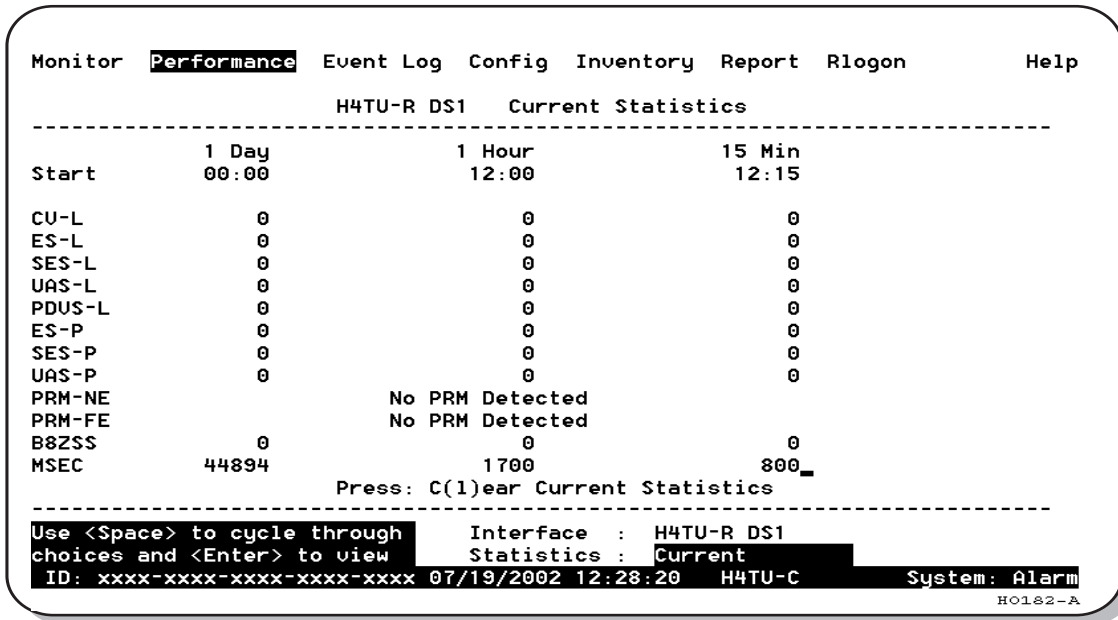

Figure 15. H4TU-R DS1 Current Statistics

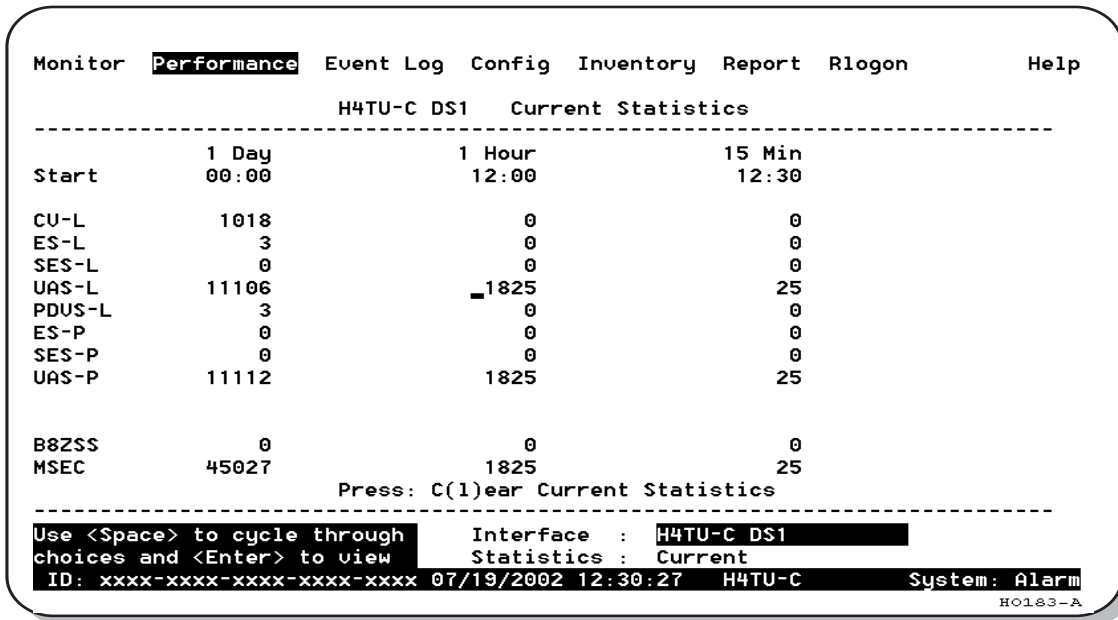

Figure 16. H4TU-C DS1 Current Statistics

**Table 9.** Error Acronyms Used on the DS1 Performance History Screens

Error Acronym	Description	Error Acronym	Description
CV-L	Code Violation - Line <sup>(a)</sup> Total BPV count.	SES-P	Severely Errored Seconds - Path Seconds with SES, CRC (ESF) $\geq 320$ , or FE <sup>(b)</sup> (SF) $\geq 8$ ( $F_T + F_S$ ).
ES-L	Errored Seconds - Line Seconds with BPV $\geq 1$ .	UAS-P	Unavailable Seconds - Path A second of unavailability based on SES-P or AIS $\geq 1$ .
SES-L	Severely Errored Seconds - Line Seconds with BPV plus EXZ $\geq 1544$ or LOS $\geq 1$ .	PRM-NE <sup>(c)</sup>	Performance Report Monitoring - Near End The PRM registers in the ESF/FDL from CPE indicate errors, and the signal received from the network at the remote is error-free.
UAS-L	Unavailable Seconds - Line Seconds with LOS $\geq 1$ .	PRM-FE <sup>(c)</sup>	Performance Report Monitoring - Far End The PRM registers in the ESF/FDL from the network indicate errors, and the signal received from the CPE is error-free.
PDVS-L	Pulse Density Violation Seconds - Line Seconds with excessive zeros (AMI = 16 zeros, B8ZS = 8 zeros).	B8ZSS <sup>(d)</sup>	B8ZS Monitored Seconds Seconds with B8ZS detection when AMI option is active.
ES-P	Errored Seconds - Path <sup>(e)</sup> Seconds with SEF <sup>(f)</sup> , CRC (ESF), or FE (SF) $\geq 1$ .	MSEC <sup>(d)</sup>	Monitored Seconds of the current (15-minute/1-hour/1-day) screen.

(a) Line (L) refers to the AMI DS1 line used to transport the payload.

(b) FE is a frame bit error.

(c) Appears on H4TU-R Performance History screens.

(d) Appears on the DS1 Current Statistics screens.

(e) Path (P) refers to the total framed payload being transported between two points.

(f) Severely Errored Frame—Two or more frame bit errors occurring in a 0.75 ms interval for SF or a 3 ms interval for ESF.

## Performance History at the HDSL4 Interface

The HDSL4 interface has 31-day, 48-hour, 25-hour, and current statistic screens for the H4TU-C. [Figure 17](#) and [Figure 18 on page 28](#) are examples of 31-day and 48-hour performance history screens. [Figure 19](#) and [Figure 20 on page 29](#) are examples of 25-hour and current statistics performance history screens. Refer to [Table 10 on page 30](#) for descriptions of the kinds of errors reported on all HDSL4 performance screens. Asterisks indicate performance monitoring from the previous day.

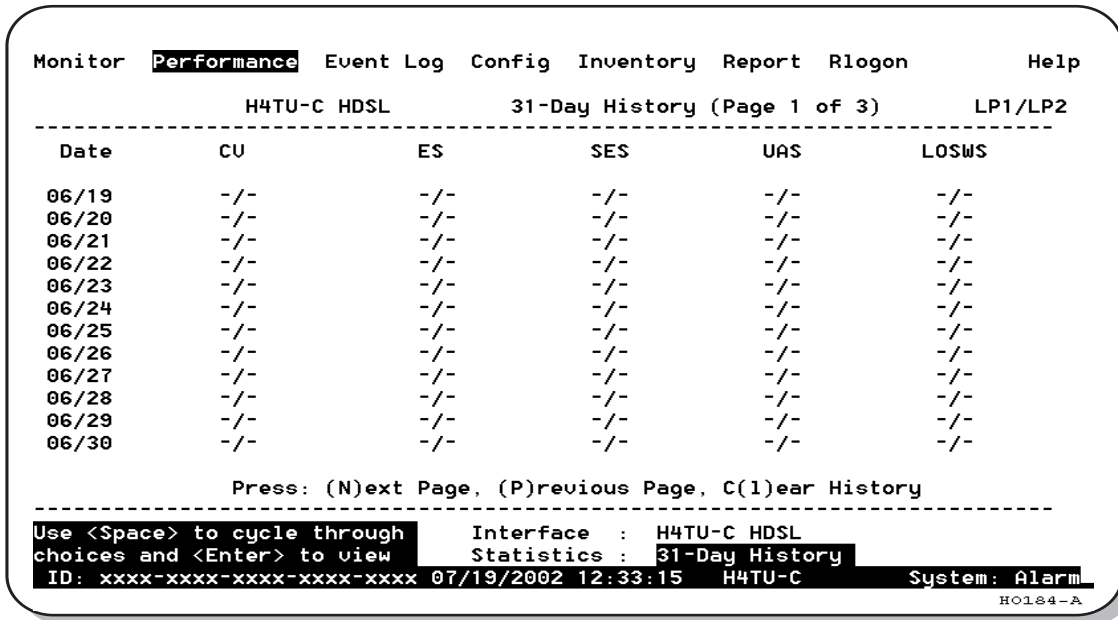

Figure 17. H4TU-C HDSL4 31-Day Performance History

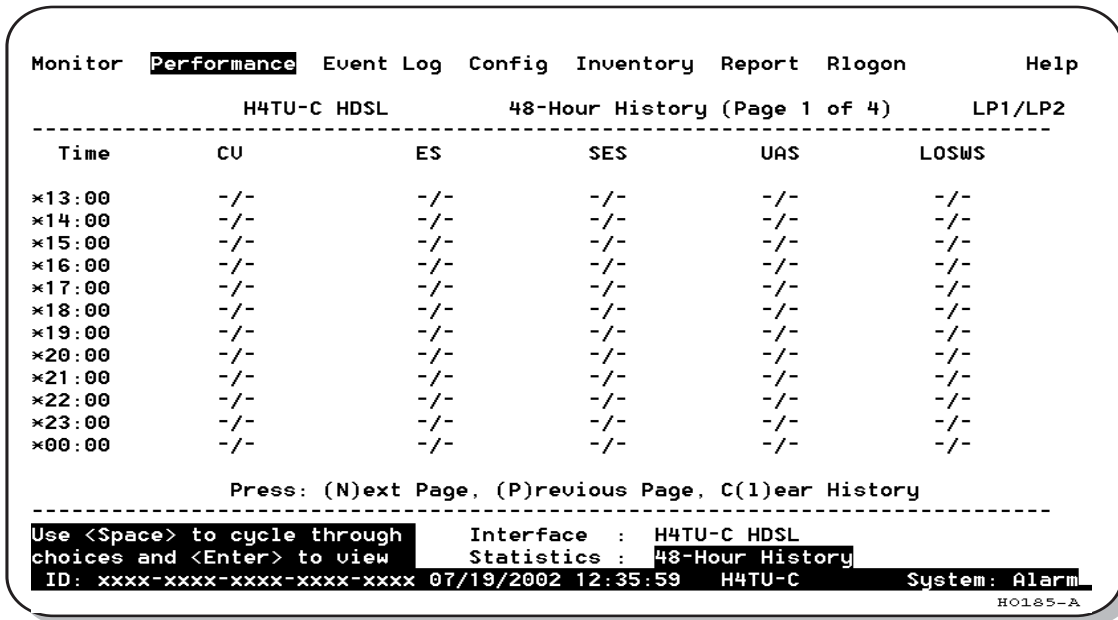

Figure 18. H4TU-C HDSL4 48-Hour Performance History

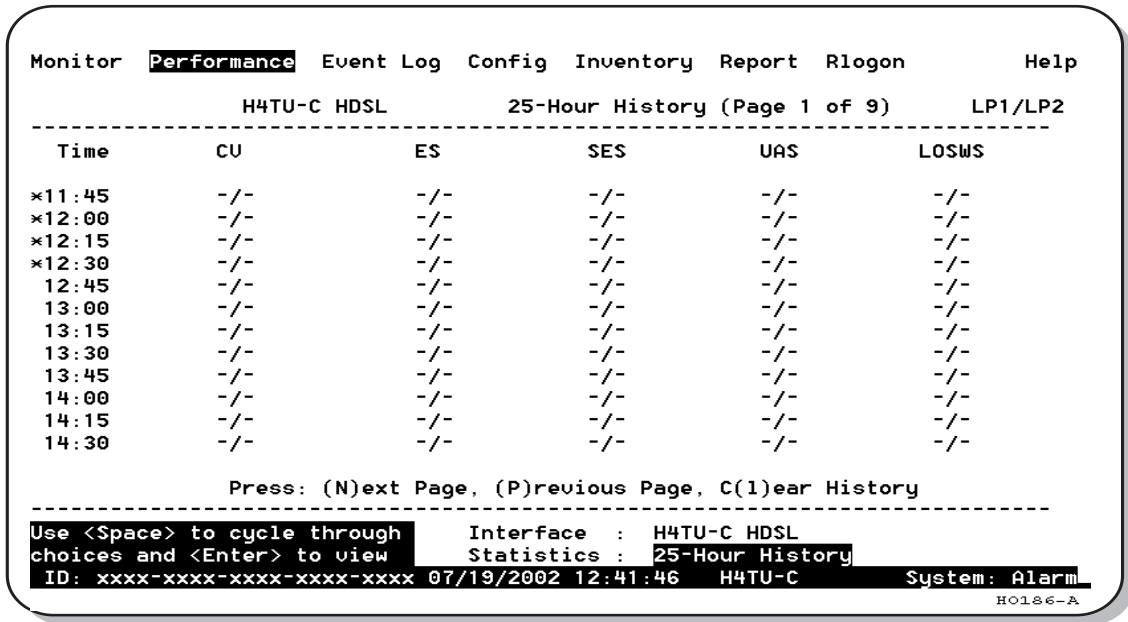

Figure 19. H4TU-C HDSL4 25-Hour Performance History

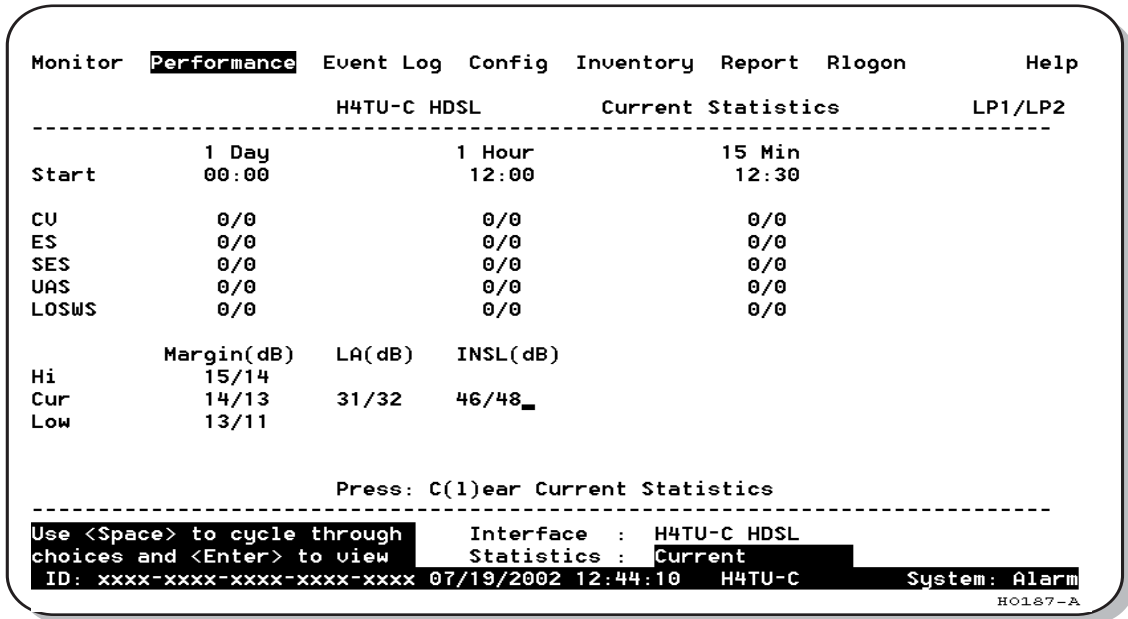

Figure 20. H4TU-C HDSL4 Current Statistics

**Table 10.** Error Acronyms Used on the HDSL4 Performance History Screens

Error Acronym	Description
CV	Code Violation Total count of HDSL4 CRC errors.
ES	Errored Seconds Seconds with HDSL4 CRC $\geq 1$ or LOSW $\geq 1$
SES	Severely Errored Seconds Seconds with HDSL4 CRC $\geq 50$ or LOSW $\geq 1$
UAS	Unavailable Seconds Based on 10 contiguous SES occurrences
LOSWS	Loss of Sync Word Second Seconds with LOSW $\geq 1$

## USING THE PERFORMANCE SCREENS TO VIEW ALARM DATA

To access the alarm history screens:

- 1 Press **P** to select the Performance screen.
- 2 Press **SPACEBAR** to select an interface (**H4TU-C DS1**, **H4TU-R DS1**, **H4TU-C HDSL**, or **H4TU-R HDSL**), then press **ENTER**.
- 3 Press **SPACEBAR** until **Alarm History** is selected, then press **ENTER**.
- 4 Press **N** or **P** to page through the alarm history screens.
- 5 Press **L** to clear the selected alarm history screen.

### Alarm History at the DS1 Interface

The Alarm History screen reports on a continuous basis the DS1 statistics for the H4TU-C (Figure 21 on page 31) and the H4TU-R (Figure 22 on page 31). The types of alarms reported are described in Table 10 on page 30. Current alarms are shown in reverse video.

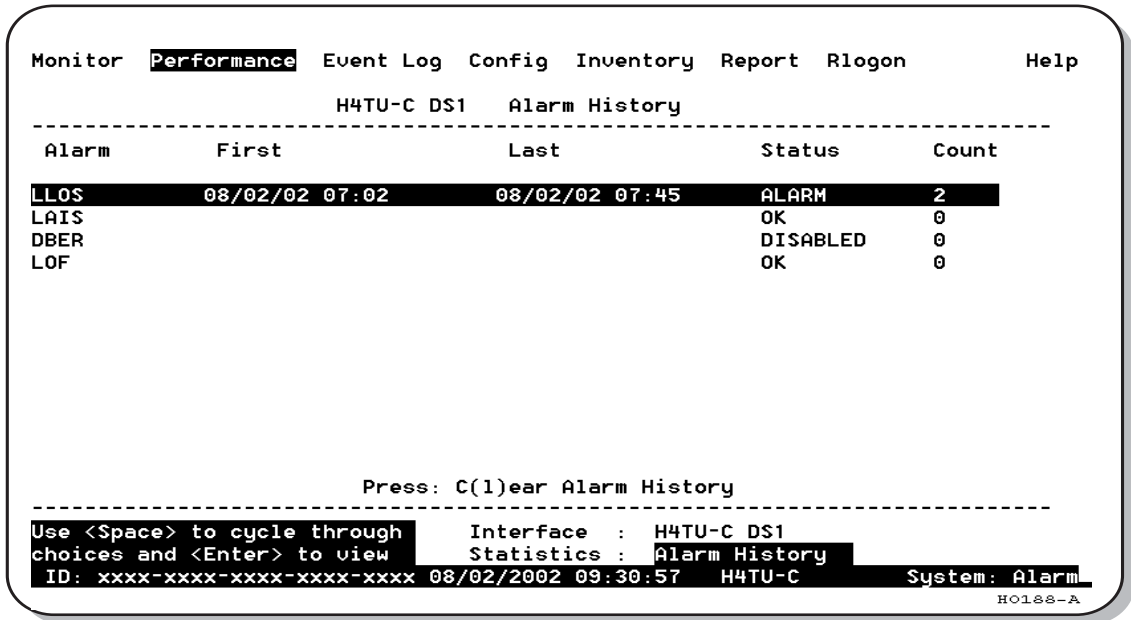

Figure 21. H4TU-C DS1 Alarm History Screen

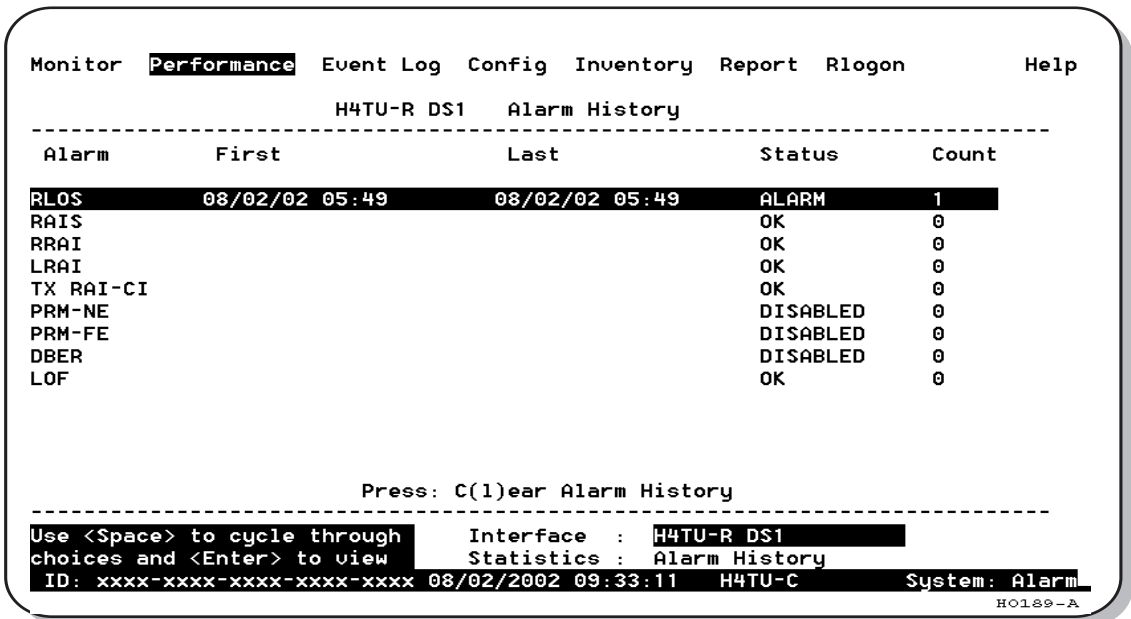

Figure 22. H4TU-R DS1 Alarm History Screen

**Table 11. DS1 Alarm Descriptions**

Message on Screen	Description
<b>H4TU-C DS1 Alarms (see Figure 21 on page 31)</b>	
LLOS	Line (Unit) Loss of Signal—Loss of the H4TU-C DSX-1 input signal.
LAIS	Line Alarm Indication Signal—Indicates an AIS (all ones) pattern is being transmitted from the local DS1 output port. The ALMP option determines whether AIS (default) or LOS is sent toward the CPE.
DBER	Bit Error Rate—The DS1 BER has exceeded the built-in 24-hour threshold limits of approximately $10^{-6}$ .
LOF	Loss of Frame—Indicates the incoming DS1 payload does not contain the specific frame pattern, ESF or SF, selected by the FRMG option. Only occurs if the FRMG option is set to SF or ESF.
<b>H4TU-R DS1 Alarms (see Figure 22 on page 31)</b>	
RLOS	Remote (Unit) Loss of Signal—Loss of the H4TU-R DS1 input signal.
RAIS	Remote Alarm Indication Signal—Indicates an AIS (all ones) pattern is being received at the H4TU-R DS1 input port. By default AIS-CI <sup>(a)</sup> is sent toward the network. See Figure 26 on page 41.
RRAI	Remote RAI - Remote Alarm Indication at the H4TU-R—Indicates an RAI alarm (yellow) from the CPE with errors from the line unit or network.
LRAI	Line Clear - Remote Alarm Indication at the H4TU-R—Indicates an RAI alarm (yellow) from the CPE with no errors from the line unit or network.
TX RAI-CI	Transmit RAI-CI - Remote Alarm Indication at the H4TU-R—Upon reception of an RAI (yellow) from the CPE, the H4TU-R sends an RAI-CI toward the network if the network signal received at the H4TU-R is clear. If the network signal is impaired (LOS, AIS, or LOF), then the RAI is passed on to the network unaltered. This is applicable to SF or ESF framing. In an all SF environment, RACI must be enabled to convert SF-RAI to SF-RAI-CI.
PRM-NE	Performance Report Monitoring - Near End—The count of the PRM-NE register at the H4TU-R exceeds the $10^{-6}$ BER threshold at 648 events since 12:00:00 AM.
PRM-FE	Performance Report Monitoring - Far End—The count of the PRM-FE register at the H4TU-R exceeds the $10^{-6}$ BER threshold at 648 events since 12:00:00 AM.
DBER	Bit Error Rate—The DS1 BER has exceeded the built-in 24-hour threshold limits of approximately $10^{-6}$ .
LOF	Loss of Frame—Indicates the incoming DS1 payload does not contain the specific frame pattern, ESF or SF, selected by the FRMG option. Only occurs if the FRMG option is set to SF or ESF.

(a) AIS-CI is a modified AIS alarm pattern. Equipment not suited to detect AIS-CI still detects this signal as an AIS. AIS-CI is sent toward the network indicating that an LOS (RLOS) or AIS (RAIS) has been received from the CPE.



## Alarm History at the HDSL4 Interface

The HDSL4 Alarm History screens report alarms at the H4TU-C and the H4TU-R. [Figure 23](#) shows the H4TU-C HDSL4 alarm history. [Table 12](#) describes the alarms that are reported at the H4TU-C or H4TU-R.

```

Monitor  Performance  Event Log  Config  Inventory  Report  Rlogon      Help
-----
                H4TU-C HDSL      Alarm History
-----
Alarm      First      Last      Status      Count
LOS W-LP1      OK      0
MAL -LP1      OK      0
LA -LP1      OK      0
HBER-LP1      OK      0
LOS W-LP2      OK      0
MAL -LP2      OK      0
LA -LP2      OK      0
HBER-LP2      OK      0
SHORT      OK      0
GND      OK      0
OPEN      OK      0

Press: C(1)ear Alarm History
-----
Use <Space> to cycle through  Interface : H4TU-C HDSL
choices and <Enter> to view  Statistics : Alarm History
ID: xxxx-xxxx-xxxx-xxxx-xxxx 07/19/2002 12:52:33 H4TU-C System: Alarm
H0190-A

```

*Figure 23. H4TU-C HDSL4 Alarm History Screen*

*Table 12. HDSL4 Alarm Descriptions*

Screen Alarm	Description
<b>HDSL4 Alarms at the H4TU-C and H4TU-R</b>	
LOS W-LP1 or LOS W-LP2	Loss of Sync Word—HDSL4 Loop 1 or Loop 2 has lost synchronization.
MAL-LP1 or MAL-LP2	Margin—The margin on HDSL4 Loop 1 or Loop 2 has dropped below the minimum threshold value set for the system.
LA-LP1 or LA-LP2	Loop Attenuation—The attenuation on HDSL4 Loop 1 or Loop 2 has exceeded the maximum value set for the HDSL4 loop attenuation threshold.
HBER-LP1 or HBER-LP2	Block Error Rate—The HDSL4 BER on Loop 1 or Loop 2 has exceeded the set threshold limits of $10^{-6}$ or $10^{-7}$ .
<b>HDSL4 Alarms at the H4TU-C only</b>	
SHORT	A short between the Tip and Ring of HDSL4 Loop 1 or Loop 2 is present.
GND	The HDSL4 Loop 1 or Loop 2 is grounded.
OPEN	A line power open condition is present.

## USING THE SYSTEM EVENT LOG TO TRACK EVENTS

The System Event Log screen (Figure 24) displays 100 of the most recent events (most recent event displayed first) and provides the following information:

- Origin tags to identify the source of a Write entry (see “Origin Tags” on page 36)
- Date and time
- Event log messages (see Table 13 on page 35)

To view a running log of system events, press **E** to select the Event Log.

- Press **N** or **P** to page through the event log.
- Press **T** to return to the top of the log.
- Press **L** to clear the event log.

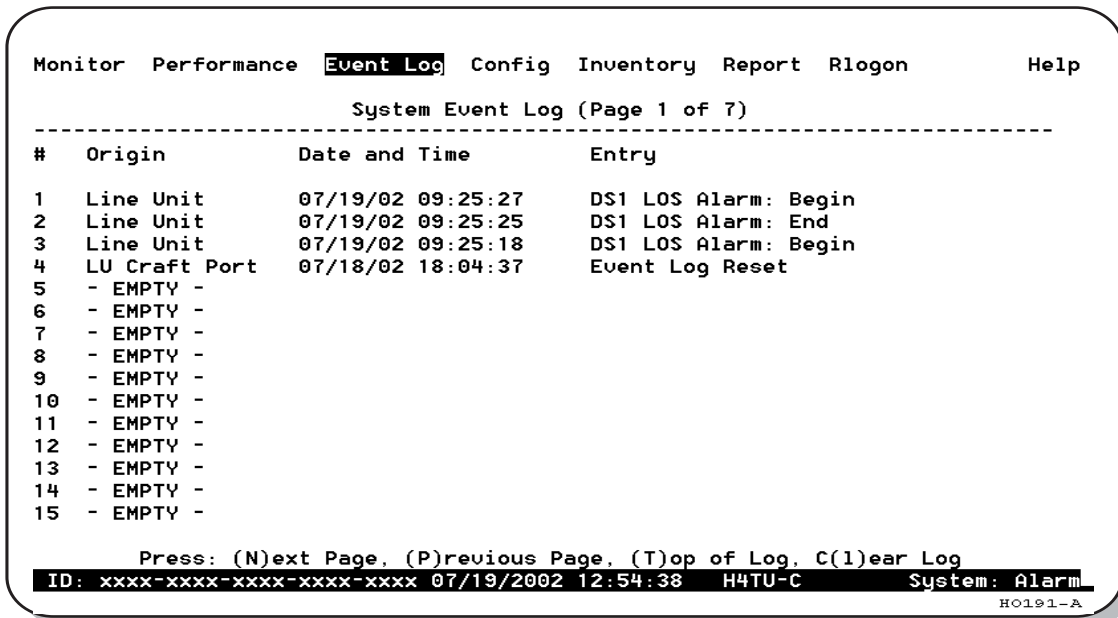

Figure 24. System Event Log

## Event Log Messages

Table 13 lists all the possible messages that can be displayed by the System Event Log screen.

**Table 13.** *Event Log Entry Messages*

Any DS1 Alarm History reset
Any DS1 PM register reset
Any HDSL4 Alarm History reset
Any HDSL4 PM register reset
Any Loop Down (any segment)
Any Loop Up (any segment)
Any provisioning option change: <provisioning mnemonic>: changed from <old> to <new>
CPE DBER alarm (1-day threshold crossed of any PM data except PRM-NE or PRM-FE)
CPE DS1 AIS begins/ends
CPE DS1 LOS begins/ends
CPE PRM-NE BER alarm ( <i>at the remote only</i> . 1-day threshold crossed of PRM-NE: trouble on CPE receive)
Current statistics reset
Event Log reset
H4TU-C Power up/down
H4TU-R Power up/down
HDSL4 DC pair open begins/ends on any segment
HDSL4 Ground fault begins/ends on any segment
HDSL4 HBER alarm (threshold crossed) on any segment.
HDSL4 loop attenuation (threshold crossed) on any HDSL4 interface
HDSL4 margin alarm (threshold crossed) on any HDSL4 interface
HDSL4 unavailability begins/ends on any segment
Master zero reset
NTWK DBER alarm (1-day threshold crossed of any PM data)
NTWK DS1 LOS begins/ends
NTWK PRM-FE BER alarm ( <i>at the remote only</i> . 1-day threshold crossed of PRM-FE: trouble on NTWK far end)
NTWK DS1 AIS begins/ends
Power Feed Open begins/ends
Power Feed Short begins/ends
RAI begins/ends
TX RAI-CI begins/ends (RAI-CI sent from the remote towards the network)

## Origin Tags

The origin tags identify the source of all Write entries and how an event occurred. The exact meaning is dependent on the type of event and the unit reporting the event. A Write entry changes a system parameter or an option setting, but it does not affect circuit status changes, such as alarms. Table 14 lists the various origin tags and their definitions.

**Table 14.** *Origin Tags*

Origin Tag	Description
<b>Provisioning changes initiated at the line unit (logged on to the line unit)</b>	
LU Craft Port	Event was initiated from the RS-232 craft port located on the H4TU-C front panel.
Management Host	Event was initiated from a host management unit, such as an H4TU-319, that sent a command over the management bus on the H4TU-C shelf backplane.
<b>Provisioning changes initiated at the line unit (logged on to the remote unit)</b>	
Line Unit	This generic origin tag can only occur when viewing the Event Log screen at the remote unit. It is a general indication that the event was initiated at the line unit. The Event Log screen must then be viewed at the line unit (through an <b>R</b> logon command) for more specific origin information.
<b>Provisioning changes initiated at the remote unit (logged on to the remote unit)</b>	
RU Front Panel	Event was initiated from the front-panel pushbutton(s) on the H4TU-R.
RU Craft Port	Event was initiated from the RS-232 craft port located on the H4TU-R front panel.
TL1 Command	Event was initiated by a non-intrusive TL1 command embedded in the FDL of the ESF DS1 signal received by the HDSL4 circuit.
<b>Provisioning changes initiated at the remote unit (logged on to the line unit)</b>	
Remote Unit	This generic origin tag can only occur when viewing the Event Log screen at the line unit. It is a general indication that the event was initiated at the remote unit. The Event Log screen must then be viewed at the remote unit (through an <b>R</b> logon command) for more specific origin information.
<b>Loopback commands</b>	
Remote Unit	Implies that the loopback command was initiated at the remote unit by the front-panel pushbuttons, craft port, or in the remote unit's DS1 input payload. A loopback initiated from a terminal would have a Remote Unit tag if the initiating terminal is in a remote logon session.
Line Unit	Implies that the loopback command was initiated at the line unit by the craft port or in the line unit's DSX-1 input payload.
<b>Alarms</b>	
Remote Unit	Indicates that the alarm occurred at the remote unit.
Line Unit	Indicates that the alarm occurred at the line unit. LOSW, SHORT, GND, and OPEN are always tagged as line unit alarms.

## USING THE REPORT MENU

The Report menu (Figure 25) provides screens containing status and performance monitoring data for line and remote units which can be downloaded to a file for analysis or future reference. Table 15 on page 38 describes the four types of reports provided by the Report menu.

To select each individual report, do the following:

- 1 Press **O** to select Report menu.
- 2 Press **SPACEBAR** to select a report type and print mode.
  - Continuous Print Mode generates a non-stop version of the report.
  - Page Mode generates a page-by-page version of the report for easy viewing on the screen.
- 3 Use your terminal emulation software (HyperTerminal or Procomm) to capture the selected report to your printer. Press **ENTER** to generate. (If Page Mode is selected, press **SPACEBAR** to continue or **ESC** to quit.)
- 4 End the captured report.
- 5 Press **CTRL + R** to refresh the Report menu screen.

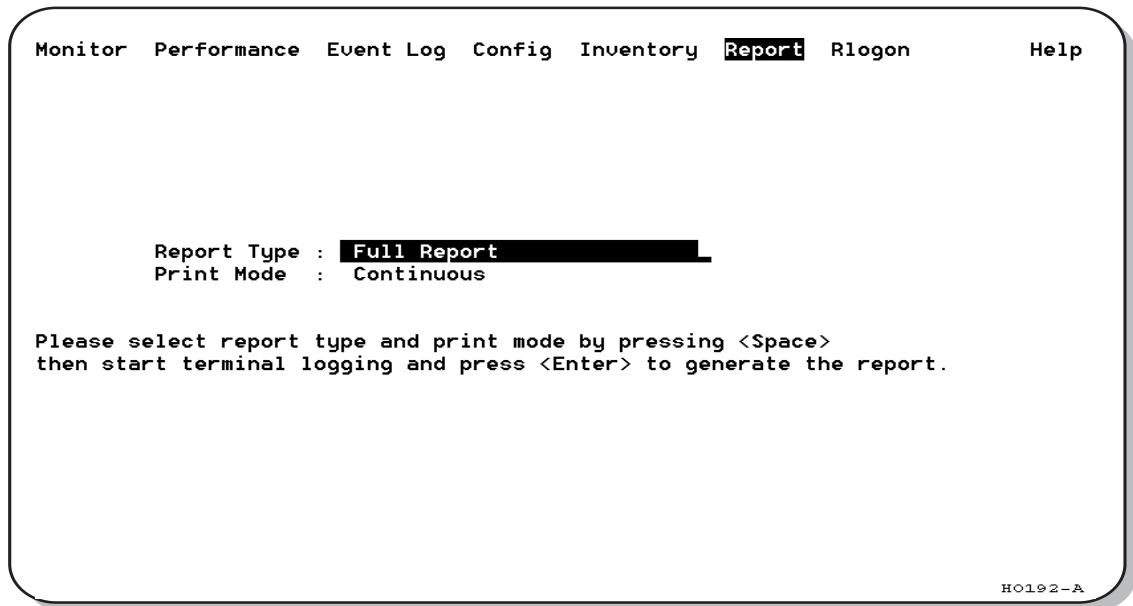

Figure 25. Report Menu - Full Report

**Table 15. Report Types**

<b>Type</b>	<b>Contains the following information:</b>
Full Report	<ul style="list-style-type: none"><li>• Circuit and unit identifications</li><li>• Product information</li><li>• System configuration</li><li>• Current performance statistics</li><li>• Alarm history</li><li>• Performance history</li><li>• System event log</li></ul>
Short Report	<ul style="list-style-type: none"><li>• Product information</li><li>• System configuration</li><li>• Current performance statistics</li><li>• Circuit and unit identification</li></ul>
System Information Report	<ul style="list-style-type: none"><li>• Circuit and unit identifications</li><li>• Product information</li><li>• System configuration</li></ul>
Event Report	<ul style="list-style-type: none"><li>• Circuit and unit identifications</li><li>• Product information</li><li>• System event log</li></ul>

# TESTING

This section provides information about system alarms, LOS and AIS response, OCT55 test procedure, and loopback testing.

## SYSTEM ALARMS

Table 16 provides a summary of the system alarms displayed on the H4TU-C, H4D doubler, and H4TU-R alarm history screens (see “Using the Performance Screens to View Alarm Data” on page 30).

**Table 16.** System Alarms Displayed on Alarm History Screens

Message on Screen	Alarm	Description	To Enable:
SHORT	Power Feed Short	A short exists between HDSL4 Loop 1 and Loop 2.	Always enabled.
GND	Power Feed Ground	One of the HDSL4 loops is grounded.	Always enabled.
OPEN	Power Feed Open	A line power open condition exists.	Always enabled.
LOSW-LP1 or LOSW-LP2	Loop( <i>n</i> )-Loss of Sync Word	HDSL4 Loop 1 or Loop 2 has lost synchronization. The span closest to the network has highest priority.	Always enabled.
LLOS	Line (Unit) Loss of Signal	Loss of the DSX-1 input signal at the H4TU-C.	Always enabled.
RLOS	Remote (Unit) Loss of Signal	Loss of the DS1 input signal at the H4TU-R.	Always enabled.
LAIS	Line Alarm Indication Signal	Indicates an AIS (unframed all ones) pattern is being received at the H4TU-C DS1 input port.	Always enabled.
RAIS	Remote Alarm Indication Signal	Indicates an AIS (unframed all ones) pattern is being received at the H4TU-R DS1 input port.	Always enabled.
LRAI	Line RAI—Remote Alarm Indication at the H4TU-R (Net signal does not have errors.)	Indicates an RAI alarm (yellow) from the CPE with an error-free signal from the line unit or network. RAI signal is transmitted towards the network.	Select DIS for the RACI option.
RRAI	Remote RAI—Remote Alarm Indication at the H4TU-R (Net signal has errors.)	Indicates an RAI alarm (yellow) from the CPE with errors from the line unit or network.	Always enabled.
TX RAI-CI	Transmit RAI-CI—Remote Alarm Indication at the H4TU-R	Upon reception of an RAI (yellow) from the CPE, the H4TU-R sends an RAI-CI toward the network if the network signal received at the H4TU-R is clear. If the network signal is impaired (LOS, AIS, or LOF), then the RAI is passed on to the network unaltered.	Select ENA for the RACI option.
DBER	DS1 Bit Error Rate	The DS1 BER has exceeded the set 24-hour threshold limit of approximately $10^{-6}$	Select ENA for the DBER system option.
LOF	Loss of Frame	The DS1 input does not contain the ESF or SF frame pattern setting of the FRMG option.	Change FRMG option to SF or ESF.

*Continued*

**Table 16.** System Alarms Displayed on Alarm History Screens (Continued)

Message on Screen	Alarm	Description	To Enable:
PRM-NE	Performance Report Messaging - Near End	H4TU-R PRM-NE BER threshold has been exceeded.	Set DBER threshold to ENA.
PRM-FE	Performance Report Messaging - Far End	H4TU-R PRM-FE BER threshold has been exceeded.	Set DBER threshold to ENA.
HBER-LP1 or HBER-LP2 <sup>(a)</sup>	HDSL4 Block Error Rate	The BER on Loop 1 or Loop 2 has exceeded the set threshold limits of $10^{-6}$ or $10^{-7}$ .	Select 1E-6 or 1E-7 for the HBER system option.
MAL-LP1 or MAL-LP2 <sup>(a)</sup>	Margin Alarm	The margin on HDSL4 Loop 1 or Loop 2 has dropped below the minimum threshold value set for the system.	User selectable; set the Margin Alarm Threshold option to >0.
LA-LP1 or LA-LP2 <sup>(a)</sup>	Loop Attenuation	The attenuation on Loop 1 or Loop 2 has exceeded the maximum value set for the HDSL4 loop attenuation threshold.	User selectable; set the HDSL4 Loop Attenuation Threshold option to >0.

(a) Only these alarms assert the System Alarm bus on pin H of the card-edge connector, if the ALM option is set to enabled.

### Alarm Option for Digital Loop Carrier (DLC) Feed

To improve compatibility with the switch-to-protect features used in DLC feeder applications, the H4TU-C-231 List 5A has an Alarm Pattern (ALMP) option that allows you to select either an AIS or LOS DS1 output payload for the following alarms:

- LOSW on any loop
- LOS DS1



## Remote LOS and AIS Response

Figure 26 shows the different ways the H4TU-R can respond to the network, depending on the setting of the NLBP, TLOS, RDA, and ALMP configuration options described in Table 5 on page 15 and Table 6 on page 16.

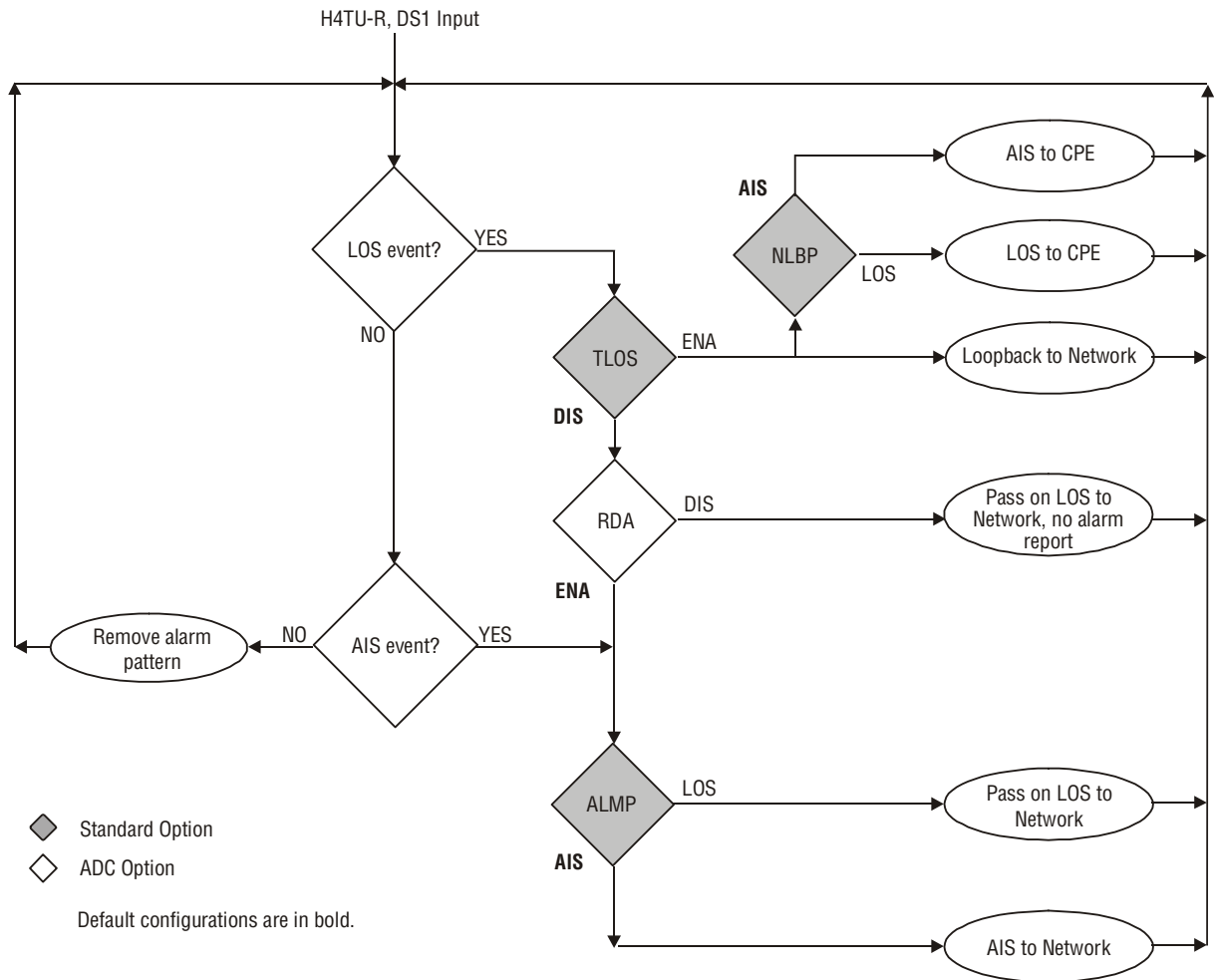

Figure 26. H4TU-R LOS and AIS Response Priorities

## OCT55 TEST PATTERN WITH AMI LINE CODE

The OCT55 test pattern can be used in unframed mode to stress the system and verify data integrity. In an SF or ESF framing mode, excessive zero anomalies may occur, which causes the H4TU-C to report ES, SES, and UAS errors according to ANSI T1.231-1997.

## LOOPBACK OPERATION

HiGain HDSL4 has a family of loopback options for analyzing circuit functionality. The loopback signal is transmitted and returned to the sending device for comparison. This allows you to verify the integrity of the HDSL4 channels to the H4TU-R remote unit and H4D doublers (if present), the H4TU-C DSX-1 interface, and the H4TU-R DS1 channels to the customer.

The HDSL4 system is enhanced to support a multiple set of loopback commands without changing any loopback configuration setting. The following three sets of loopback commands can be initiated simultaneously:

- Generic Loopback (GNLB) commands, including the SmartJack (SMJK) loopback commands (see [Table 17 on page 45](#))
- A3LB Addressable Repeater Loopback commands (see [Table 18 on page 47](#))
- A5LB Addressable Repeater Loopback commands (see [Table 19 on page 48](#))

Loopback commands can be initiated by:

- Entering the loopback code into the test equipment connected to the H4TU-C or H4TU-R.
- Selecting and activating the loopback type from the Monitor menu when connected to the craft port of the H4TU-C or H4TU-R (see “[Loopback Testing Using a Maintenance Terminal](#)” on page 50).
- Using the loopback pushbuttons (LLB and RLB) on the H2TU-R (see “[Loopback Testing Using Remote Unit Front-Panel Pushbuttons](#)” on page 50).



**HiGain supports multiple loopbacks, but a single loopback is the preferred method. HDSL4 automatically rejects activation of closed loop loopbacks. For example, an NREM and CREM cannot be activated at the same time.**

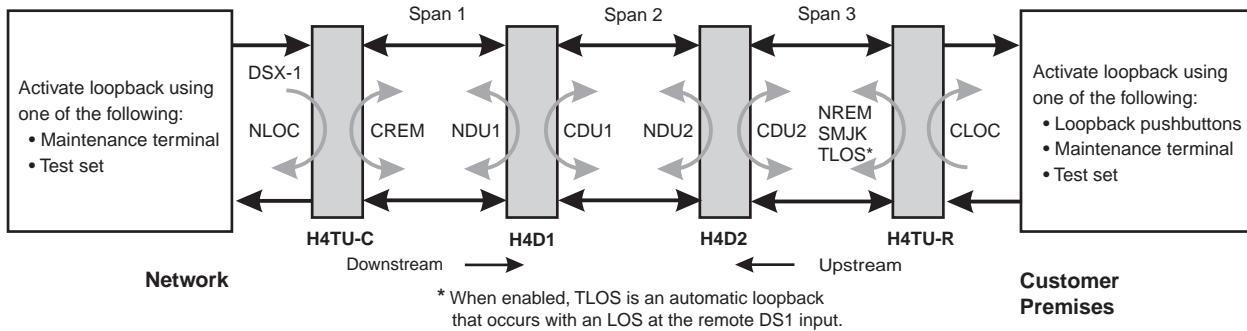

*Figure 27. Loopback Summary*

## Generic Loopback Commands

The HDSL4 Generic Loopback (GNLB) commands allows the use of inband codes to loop up either NLOC (4-in-7) or NREM (3-in-7) towards the network. Additionally, these inband codes loop up CREM (6-in-7) or CLOC (5-in-7) towards the customer. Either loopup condition can be terminated (looped down) with the 3-in-5, SMJK loopdown code. All inband codes must be present for at least 5 seconds before the HDSL4 system responds. TLOS is a logic loopback caused by loss of the DS1 input from the CI.

Figure 27 summarizes the available loopbacks in the system, and Table 17 on page 45 summarizes the HDSL4 generic loopback commands. See “GNLB Test Procedures” on page 44 for the test procedures that apply when using the GNLB mode.



**HiGain systems feature the SmartJack option which can emulate a Network Interface Device (NID) for loopback testing of the HDSL4 circuit. SMJK and NREM loopbacks perform the same functions, but their initiation differs. SMJK indicates that the loopback was initiated by the 2-in-5 inband command. Conversely, NREM is initiated by the 3-in-7 inband command, or by a command issued from the maintenance terminal.**

**Use the inband commands to enable or disable the SMJK loopback options. The HDSL4 system setting is normally enabled to recognize all inband SmartJack loopback commands.**

## A3LB and A5LB Loopback Commands

A3LB and A5LB loopback commands can be sent by a test set connected to the H4TU-C or H4TU-R. See Table 18 on page 47 and Table 19 on page 48 for a list of the commands.

A3LB and A5LB are special, addressable, repeater loopback modes which are supported by the H4TU-C. These loopback modes provide the HDSL4 system with sophisticated maintenance and troubleshooting tools. A3LB and A5LB are patterned after the Westell addressable T1 repeater loopbacks.

The A5LB loopback selection complies with that proposed for HDSL4 systems in the T1E1.4/92 loopback recommendation with the following additions:

- Query loopback
- IOR (Intelligent Office Repeater) power-down
- Four loopback time-out choices
- Initiation from either end
- Repeating bit error signatures
- Alternate query loopback

A5LB does not block the arming code from exiting the H4TU-C into the network. Since A5LB never blocks the arming code from exiting the H4TU-C, the Far-End Activate code is not available in A5LB. A3LB supports the additional (1-in-6) SMJK loopback command.



**SMJK loopback commands are activated only by inband commands.**

## LOOPBACK TEST PROCEDURES

The following sections provide step-by-step test procedures for verifying the integrity of the HDSL4 channels at every module location as well as the DS1 channels to the customer and the local DSX-1 interface.

### General Troubleshooting Tips

If trouble is encountered on the DSX-1 interfaces of the H4TU-C, verify that the:

- H4TU-C is making a positive connection with its mounting assembly (shelf) connector.
- H4TU-C internal equalizer is set to the correct distance range per [Table 5 on page 15](#). All equalizers should be set to the distance from the DSX-1 to the shelf.

### Setting the Loopback Time-Out Option

Before activating a manual loopback, verify that the Loopback Time-Out option is set to the desired value. [Table 5 on page 15](#) describes this option.

- 1 Log on to the maintenance terminal.
- 2 Press **ESC** to clear the screen, then press **C** to select the Config menu.
- 3 Select **Standard Options**, then **LBTO**.
- 4 Press the **SPACEBAR** to select the LBTO, then press **ENTER**.

### GNLB Test Procedures

[Figure 28 on page 46](#) is a graphical representation of the various loopback configurations with the associated GNLB commands shown. See [Table 17 on page 45](#) for a description of these commands.

To perform the GNLB loopback test procedure:

- 1 Have the CO tester send the NREM (3-in-7) inband loopup code for 5 seconds. Observe the NREM message on the front-panel display. The RLB/LLB LED on the H4TU-R front panel should be green, and the loopback mode should also be identified on the Monitor screen.
- 2 Have the CO tester transmit a DS1 test signal toward the H4TU-C and verify that the returned (looped) signal to the test set is error-free.
- 3 If [Step 2](#) fails, have the CO tester transmit the (3-in-5) inband loopdown code.
- 4 Have the CO tester send the NLOC (4-in-7) inband loopup for 5 seconds. Observe the NLOC message on the front-panel display. The LBK LED on the H4TU-C front panel should be yellow, and the loopback mode should also be identified on the Monitor screen.
- 5 Repeat [Step 2](#). If the test passes, the problem is in the downstream direction. If it fails, the problem is in the upstream direction.

**Table 17.** Summary of HDSL4 Generic Loopback Codes and Activation Methods

Loopback	Code	Description	Method of Activation	
			Test Set	Craft Port
NLOC	1111000 4-in-7	DSX-1 signal is looped back to the network at the H4TU-C.	X	X
NREM	1110000 3-in-7	DSX-1 signal is looped back to the network at the H4TU-R.	X	X
NDU1	110000 2-in-6	Signal is looped back to the network at H4D1.	X	X
CDU1	111100 4-in-6	DS1 signal from customer is looped back to the customer at H4D1.	X	X
NDU2	111000 3-in-6	Signal is looped back to the network at H4D2.	X	X
CDU2	111110 5-in-6	DS1 signal from customer is looped back to the customer at H4D2.	X	X
CLOC	1111100 5-in-7	DS1 signal from the customer is looped back to the customer at the H4TU-R.	X	X
CREM	1111110 6-in-7	DS1 signal from the customer is looped back to the customer at the H4TU-C.	X	X
SMJK LpUp (PL) <sup>(a)</sup>	11000 2-in-5	SmartJack Loopup or NID payload (PL) code. Invokes H4TU-R loopback towards network.	X	
SMJK LpUp (ESF-DL) <sup>(a)</sup>	1111-1111-0100-1000	SmartJack Loopup or NID (ESF-DL) code. Invokes H4TU-R loopback towards network.	X	
SMJK LpDn (PL)	11100 3-in-5	SmartJack Loopdown or NID payload (PL) code. Removes SMJK, NLOC, NREM, CLOC, and CREM.	X	
SMJK LpDn (ESF-DL)	1111-1111-0010-0100	SmartJack Loopdown or NID (ESF-DL) code. Removes SMJK, NLOC, NREM, CLOC, and CREM.	X	
SMJK LpUp <sup>(a)</sup>	100000 (1-in-6)	SmartJack Loopup code from the network. Invokes H2TU-R loopback towards network.	X	
SMJK LpDn	100 (1-in-3)	SmartJack Loopdown code from the network or customer interfaces. Removes any loopback in the system.	X	

(a) This loopback command is valid only when the SmartJack Loopback option (LPBK) is ENABLED.

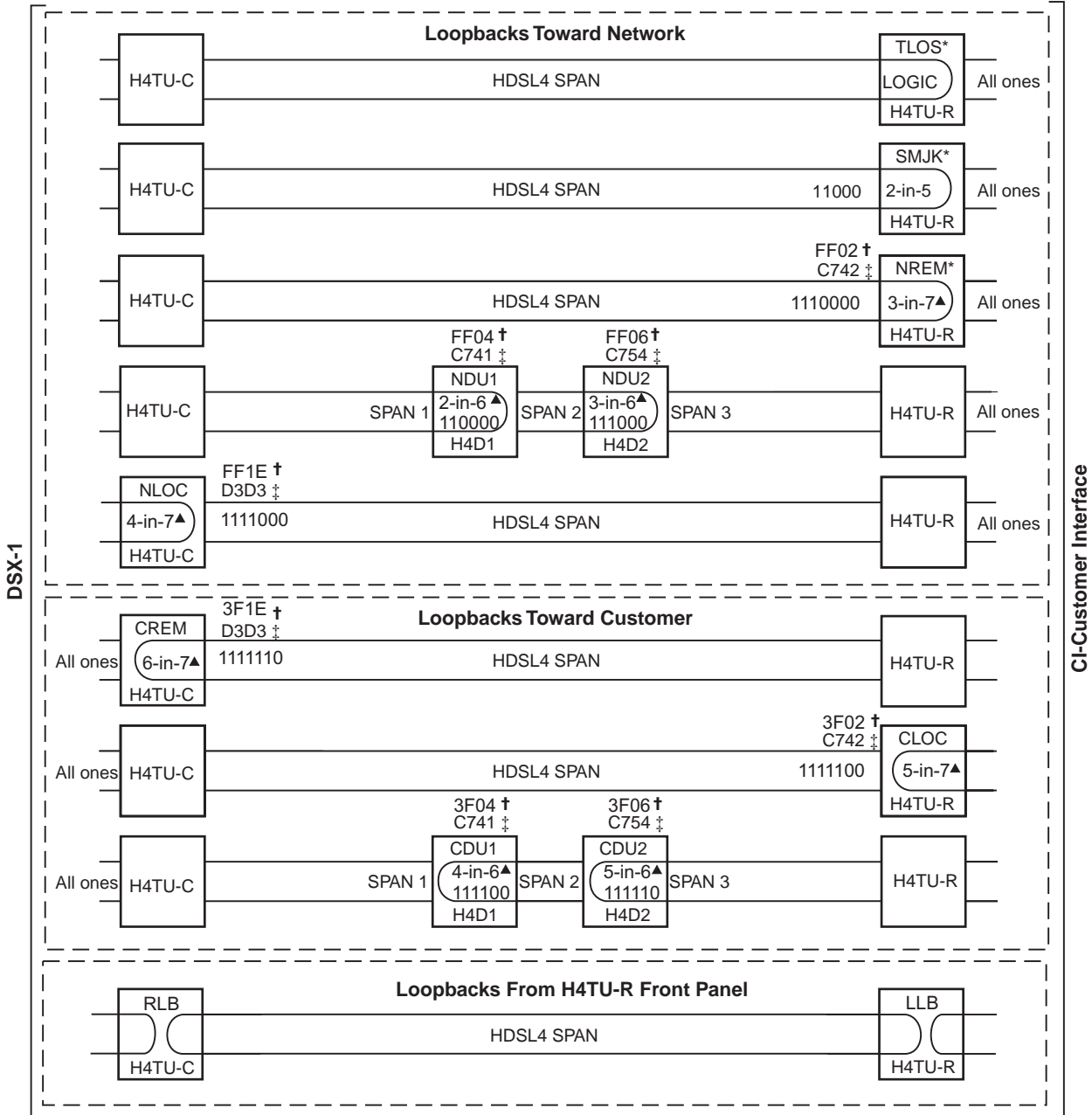

\* Set the NLBP option to AIS to send AIS (indicated by an all ones pattern) for any network loopback.

† A3LB loopback codes.

‡ A5LB loopback codes.

▲ GNLB loopback codes.

H0197-A

Figure 28. Loopback Modes



The H4TU-C is enhanced to respond to the IR Query LPBK code (D5D5) when a SMJK loopback is activated.

## A3LB Test Procedures

The H4TU-C can be looped back by sending the Addressable Office Repeater (AOR) LPBK activation code 1111-1111-0001-1110 (FF1E) for at least 5 seconds. This causes the H4TU-C to enter the NLOC state. The Loopback Time-Out setting determines the duration of this loopback unless it is overridden by the reception of a second identical 16-bit loopup command before the timer expires. When this time-out override state exists, the only method to loop the H4TU-C down is to issue one of the three loopdown commands listed in Table 18. The automatic time-out mode is restored during subsequent loopback sessions.

Table 18 summarizes the codes required to execute Addressable 3 (A3LB) repeater loopback commands. All code sequences must be present for at least 5 seconds.

**Table 18.** A3LB Addressable Repeater Loopback Commands

Name	Binary Code <sup>(a)</sup> (Hexadecimal Equivalent)	Description
NLOC	1111-1111-0001-1110 (FF1E)	H4TU-C loopup from NI.
CREM	0011-1111-0001-1110 (3F1E)	H4TU-C loopup from CI.
NREM	1111-1111-0000-0010 (FF02)	H4TU-R loopup from NI.
NDU1	1111-1111-0000-0100 (FF04)	Signal is looped back to the network at H4D1.
CDU1	0011-1111-0000-0100 (3F04)	DS1 signal from customer is looped back to the customer at H4D1.
NDU2	1111-1111-0000-0110 (FF06)	Signal is looped back to the network at H4D2.
CDU2	0011-1111-0000-0110 (3F06)	DS1 signal from customer is looped back tot he customer at H4D2.
CLOC	0011-1111-0000-0010 (3F02)	H4TU-R loopup from CI.
SMJK <sup>(b)</sup>	11000-11000-11000 ...	H4TU-R loopup from NI.
SMJK <sup>(b)</sup>	100000 100000 100000 ...	H4TU-R loopup from NI.
SMJK <sup>(b)</sup>	1111-1111-0100-1000 (FF48)	H4TU-R loopup from NI (ESF-DL).
Loopdown	11100-11100-11100 ...	H4TU-C and H4TU-R loopdown from NI OR CI.
Loopdown	100-100-100 ...	H4TU-C and H4TU-R loopdown from NI OR CI.
Loopdown	1111-1111-0010-0100 (FF24)	H4TU-C and H4TU-R loopdown from NI OR CI (ESF-DL).

(a) The leftmost bit arrives first in all sequences. The detection algorithm functions reliably with a random  $10^{-3}$  Bit Error Ratio (BER) on the facility. The entire arming and loopback sequence can also be initiated at the remote H4TU-R location.

(b) This command is valid only when the SMJK loopback option (LBPK) is enabled.

## A5LB Test Procedures

Using the codes listed in [Table 19](#), a network tester can activate NLOC or NREM loopbacks (or SMJK, if enabled). A tester at the customer premises can activate CLOC or CREM loopbacks. Information specific to doublers is shown in bold type.

**Table 19.** A5LB Addressable Repeater Loopback Commands

Name	Binary Code <sup>(a)</sup> (Hexadecimal Equivalent)	Description
ARMING or NI LPBK (inband)	11000-11000 ...	Arming code
ARMING or NI LPBK (ESF Data Link)	1111-1111-0100-1000 (FF48)	Arming code
IR LPDN or DISARM (inband)	11100-11100 ...	Disarming code
IR LPDN or DISARM (ESF Data Link)	1111-1111-0010-0100 (FF24)	Disarming code
IOR LPBK (NLOC or CREM) 230-232 bit errors 229-231 bit errors <sup>(b)</sup>	1101-0011-1101-0011 (D3D3)	H4TU-C loopup
ILR-1 LPBK (NDU1 and CDU1 10 bit errors)	1100-0111-0100-0001 (C741)	Doubler-1 loopup
ILR-20 LPBK (NDU2 and CDU2 200 bit errors)	1100-0111-0101-0100 (C754)	Doubler-2 loopup
ILR-2 LPBK (NREM and CLOC 20 bit errors)	1100-0111-0100-0010 (C742)	H4TU-R loopup
ILR-2 LPBK (NREM or CLOC) 20 bit errors <sup>(c)</sup>	NREM—DSX-1 signal is looped back to the network at the H4TU-R. CLOC—DS1 signal from customer is looped back to the customer at the H4TU-R.	1100-0111-0100-0010 (C742)
IR LPDN	1001-0011-1001-0011 (9393)	Loopdown (H4TU-C or H4TU-R)
IR QUERY LPBK	1101-0101-1101-0101 (D5D5)	Query loopback
IR ALTERNATE QUERY LPBK	1101-0101-1110-1010 (D5EA)	Alternate query loopback
TIME-OUT OVERRIDE	1101-0101-1101-0110 (D5D6)	Loopback time-out override
IOR POWER DOWN (H4TU-C) <sup>(d)</sup>	0110-0111-0110-0111 (6767)	Removes HDSL4 line power

- (a) The leftmost bit arrives first in all sequences. The detection algorithm functions reliably with a random  $10^{-3}$  BER on the facility. The entire arming and loopback sequence can also be initiated at the remote H4TU-R location.
- (b) The H4TU-R identifies CREM (and the H4TU-C identifies NLOC) with 231 bit errors, including the frame bits. When framed data is being sent in the Auto framing mode, the number of the 231 bit errors detected by the test set varies from 229 to 231, depending on whether or not the test set counts frame errors as bit errors, and on the number of frame bits contained in the block of 231 error bits. The H4TU-R and H4TU-C generate this bit pattern in a series of discontinuous bursts containing 20-bit errors each, including frame bits. Those test sets that do not count frame error bits as data bit errors will indicate fewer bits than the H4TU-R and H4TU-C transmit for a CI and NI loopback.
- (c) The H4TU-R is assigned the ILR-2 loopback code. It responds with 20 bit errors (excluding the frame bits).
- (d) The IOR Power Down code must remain present for the duration of the power down mode. When this code is removed, the system returns to its normal unlooped and unarmed state.



To perform the A5LB test procedures:

- 1 Send the inband Arming and NI LPBK code 11000 to the H4TU-C for at least 5 seconds.
- 2 Monitor the output of the H4TU-C for the return of the pattern. Return of the pattern indicates one of the following:
  - The H4TU-R has looped up (if the SMJK Loopback option is enabled).
  - An external NID has looped up (if the SMJK Loopback option is disabled), and the H4TU-C and H4TU-R have been armed.
- 3 Verify, if possible, that the H4TU-R Loopback LED is either flashing yellow at four times per second (indicating that the system is armed), or is a steady green (indicating that it is in SMJK loopback). The H4TU-C LBK LED also flashes yellow when the system is armed.



**If the Arming code is not returned after 5 seconds, the system may be armed, but there is no active loopback.**

- 4 Once armed, the H4TU-C can be looped back by sending Intelligent Office Repeater (IOR) LPBK activation code 1101-0011-1101-0011 (D3D3) for at least 5 seconds. You should observe the following activation response pattern in the order presented:
  - 2 seconds of AIS (all ones pattern)
  - 2 seconds of returning data pattern
  - Logic errors (including the frame bit) occurring in the returned pattern comprising:
    - 231 errors, if IOR LPBK (H4TU-C) was sent
    - 20 errors, if ILR-2 (H4TU-R) was sent
    - 20 errors, if ILR-2 (H4TU-R) was sent
  - Normal looped data

This error pattern repeats every 20 seconds as long as the IOR loopback pattern is being sent. This also applies to ILR, Time-Out Override, and Query commands.



**Some Intelligent Repeater (IR) test sets do not count frame errors as bit errors when the test pattern is framed and the H4TU-C-231 List 5A is set to the Auto framing mode. To improve compatibility with those test sets, the H4TU-C generates 231 (NLOC and CREM) ID bit errors. As a result, the H4TU-C may indicate one more or one less bit error, depending on the test set type and the number of frame bits contained in the block of errored bits. To avoid this uncertainty, ADC recommends sending unframed IR commands.**

The H4TU-C is now in logic loopback if the IOR NLOC loopback command was sent. The Time-Out Override command or a Loopdown command can override the selection made for the loopback time-out (see [“Setting the Loopback Time-Out Option” on page 44](#)). If the Time-Out Override code 1101-0101-1101-0110 (D5D6) is received after activating a loopback, then the automatic timed expiration of the loopback is inhibited. If this Time-Out Override is sent, then the only way to loop the H4TU-C down is to do one of the following:

- Issue the IR (Intelligent Repeater) LPDN (loopdown) code 1001-0011-1001-0011 (9393).
- Issue the NI LPDN and Disarm inband code 11100 or the ESF-DL code (FF24).



**The Time-Out Override function is only valid for the current active loopback. The automatic time-out timer is restored during subsequent loopback sessions.**

- 5 Once the test is complete, do one of the following:
  - If the system is to loopdown but remain armed, send the IR (Intelligent Repeater) LPDN code (universal loopdown).
  - If all the equipment is to be looped down, disarmed and returned to normal operation, send the disarm inband code 11100 or the ESF-DL code (FF24).



**The Armed mode has an automatic time-out of 120 minutes, but this timer is reset to 120 for any of the following events:**

- **Loopback terminates (manually or time-out)**
- **Query**
- **Alternate query**
- **Far End activate**
- **Another ARM command**

**This timer is inhibited while any of the valid command codes are being sent. Once the codes are removed, the timer restarts at 120.**

## Loopback Testing Using a Maintenance Terminal

To activate a loopback session using a maintenance terminal:

- 1 Press **ESC** to clear the Config menu, then press **M** to select the Monitor screen.
- 2 Press the **SPACEBAR** to select the **NLOC**, **CREM**, **NDU1**, **CDU1**, **NDU2**, **CDU2**, **NREM**, or **CLOC** loopback, then press **ENTER** to activate the loopback. Press **Y** to confirm.
- 3 To manually terminate the loopback, press the **SPACEBAR** to select **LPDN**, then press **ENTER**. Press **Y** to confirm.

## Loopback Testing Using Remote Unit Front-Panel Pushbuttons

On the H4TU-R front panel, press the appropriate pushbutton for 5 or more seconds:

- **LLB** - to activate a dual loopback at the H4TU-R (NREM + CLOC).
- **RLB** - to activate a dual loopback at the H4TU-C (NLOC + CREM).

To loopdown any active loopback in the system, including SMJK and TLOS, press the LLB or RLB pushbutton for 5 or more seconds. To activate a dual loopback after a loopdown, again press the LLB or RLB pushbutton for 5 or more seconds.

## Programmable DSX-1 Test Jacks

The H4TU-C front panel DSX-1 LINE jacks can be configured for intrusive test access of the signal to/from the network or to/from the customer (default setting). The front panel DSX-1 MON jacks always provide non-intrusive monitoring of the DSX-1 signal to and from the customer.



**Use of the programmable DSX-1 LINE jacks will interrupt normal traffic flow.**

When performing intrusive testing to the customer, configure the DS1 Test Jack direction for "CPE." Connect the DS1 Test Equipment to the DSX-1 LINE jacks as shown in [Figure 29 on page 51](#). The signal from the network is disconnected and no DS1 signal is transmitted to the network.

When performing intrusive testing to the network, configure the DS1 Test Jack direction for "NET." Connect the DS1 Test Equipment to the DSX-1 LINE jacks as shown in [Figure 30 on page 51](#). An LLOS is reported at the H4TU-C and an AIS or LOS is sent to the customer.

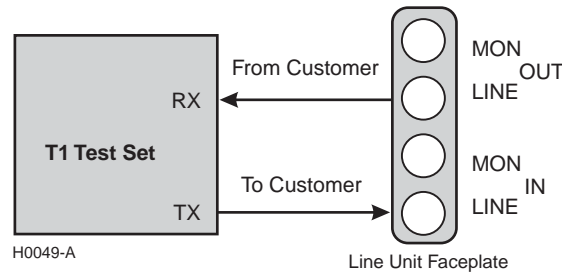

**Figure 29.** DSX-1 Testing Towards Customer

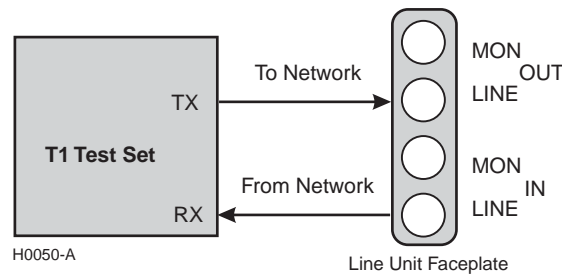

**Figure 30.** DSX-1 Testing Towards Network

To configure the DSX-1 LINE jacks for test access to the network or customer:

- 1 Press **C** to select the Config menu.
- 2 Use the **↑** and **↓** arrow keys to select **DS1 Test Jack** (Figure 31), then press **ENTER**.
- 3 Use the **SPACEBAR** to select network access (**NET**) or customer access (**CPE**), then press **ENTER**.

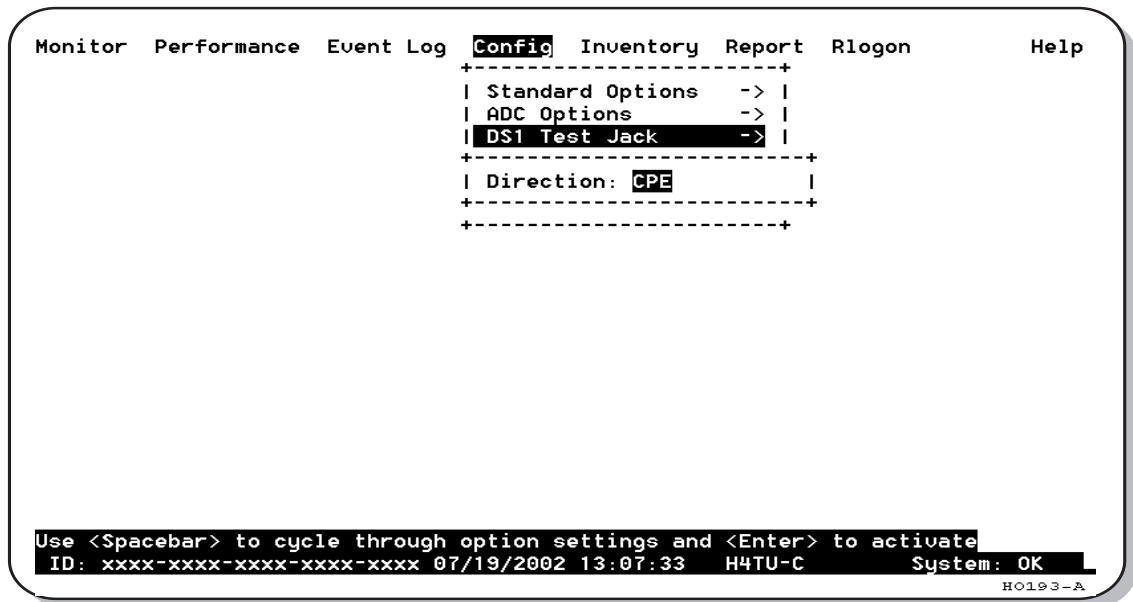

**Figure 31.** DSX-1 Test Jack Screen

# APPENDIX A - SPECIFICATIONS

## Power

HDSL4 Span Voltage	0 or -185 Vdc (voltage is applied across Loop 1 and Loop 2)
CO Supply	-48 Vdc nominal (-42.5 Vdc to -56.5 Vdc) See “Power Consumption” and “Maximum Power Dissipation” and “Maximum Current Drain” on page 54.
Electrical Protection	Secondary surge and power cross protection on HDSL4 ports. Requires external primary protection.
Fusing	Internal; connected to “FUSE ALARM” output on <a href="#">pin 32</a>

## Environmental

Operating Temperature	-40°F to +149°F (-40°C to +65°C)
Operating Humidity	5% to 95% (non-condensing)

## Physical

Height	5.9 in. (15.0 cm)
Width	1.4 in. (3.5 cm)
Depth	10 in. (25.4 cm)
Weight	0.5 lb (.23 kg)
Mounting	220 mechanics high-density shelves

## HDSL4

Line Rate	784 kbps Overlapped Pulse Amplitude Modulation (OPAM) transmission per HDSL4 standard in ANSI T1.418 Issue 2.
Transmission	Full duplex
Media	Two unconditioned copper pairs
Output	+14.1 dBm $\pm$ 0.5 dBm at 135 $\Omega$
Line Impedance	135 $\Omega$
Maximum Insertion Loss	Span 1 = 47 dB at 196 kHz Span 2 and Span 3 = 43 dB at 196kHz (for locally powered system)
Maximum Loop Attenuation	Span 1 = 31 dB Span 2 and Span 3 = 29 dB
Start-up Time	30 sec. (typical), 1 min. (maximum) per span

## DSX-1

Line Impedance	100 $\Omega$
Line Rate	1.544 Mbps $\pm$ 200 bps
Line Format	Alternate Mark Inversion (AMI) or Bipolar with 8-Zero Substitution (B8ZS)
Frame Format	Extended SuperFrame (ESF), SuperFrame (SF), or Unframed (UNFR)
Pulse Output	6 V <sup>pk-pk</sup> pre-equalized for 0 to 655 feet of ABAM cable
Input Level	+1.5 to -7.5 dB DSX

## System

One-way DS1 Delay	<700 $\mu$ s
Wander (Looped)	Meets MTIE T1.101 requirements
Wideband Jitter (Looped)	0.2 UI maximum
Narrowband Jitter (Looped)	0.1 UI maximum

## POWER CONSUMPTION

The three most important power parameters of an H4TU-C are its maximum power consumption, maximum power dissipation, and maximum current drain.

Table 20 describes line-powered and locally powered (remote) circuits on the maximum reach condition using 26 AWG wire.

Table 20. H4TU-C Power Parameters

Number of Doublers	Remote Power Source	-48 Vdc Power Consumption (Watts)		Heat Dissipation (Watts)		-42.5 Vdc Current (mA)	
		Typical	Maximum	Typical	Maximum	Typical	Maximum
None	Locally powered	7.6	8.4	5.9	6.4	179	197
None	Line-powered	11.0	12.1	6.2	6.8	259	285
1	Locally powered	14.6	16.1	6.6	7.2	344	378
1	Line-powered	20.0	22.0	7.1	7.8	471	518
2	Locally powered	26.7	29.4	8.4	9.2	628	691
2	Line-powered	32.9	36.2	9.3	10.3	774	852

## MAXIMUM POWER DISSIPATION

The maximum power dissipation measures the power that is converted into heat that builds up within the unit. It contributes to the total heat generated in the space around the unit. It is used to determine the maximum number of fully loaded shelves per bay that does not exceed the maximum allowable power dissipation density in watts per square foot to comply with GR-63.

In COs, the maximum power dissipation for open-faced, natural convection-cooled mountings is limited to 134.7 watts per square foot per GR-63-CORE. Use this limit and the parameters in Table 21 on page 54 to determine the maximum number of H4TU-C circuits that can occupy one CO bay.



**This is a worst case situation since it assumes the entire CO is subjected to the maximum power density. More favorable conditions would permit increasing the number of shelves per bay without jeopardizing the CO thermal integrity.**

The thermal loading limitations imposed when using the H4TU-C in a Controlled Environmental Vault (CEV) or other enclosures are determined by applying its power parameters to the manufacturer's requirements for each specific housing.

The -48 Vdc power consumption is the maximum total power that the H4TU-C consumes or draws from the shelf power source. This parameter is needed when the H4TU-C is in a location remote to the CO it is serving. It determines the battery capacity required to maintain an 8-hour, standby battery reserve for emergency situations. Battery capacity, therefore, limits the maximum number of line units which can be installed in a remote enclosure. Use the data in Table 20 on page 53 to perform this analysis.

## MAXIMUM CURRENT DRAIN

The maximum current drain is the maximum current drawn from the shelf power supply when its at its minimum voltage (-42.5 Vdc). This determines the shelf fusing requirements. Use the -42.5 Vdc current data in [Table 20](#) on [page 53](#) to determine the shelf fusing requirements for your particular H4TU-C applications.

## LOOP ATTENUATION, INSERTION LOSS, AND REACH

For Span 1, each loop has no more than 47 dB of insertion loss at 196 kHz, with driving and terminating impedances of 135 $\Omega$ , as shown in [Table 21](#) below. This is equivalent to no more than 31 dB loop attenuation.

For Span 2 and Span 3, each loop has no more than 43 dB of insertion loss at 196 kHz, with driving and terminating impedances of 135 $\Omega$ . This is equivalent to no more than 29 dB loop attenuation. The 3-span system should be locally powered to achieve this maximum reach.

*Table 21. HDSL4 Reach Chart*

Cable Gauge	Insertion Loss <sup>(a)</sup> at 196 kHz (dB/kft)	Loop Attenuation (dB/kft)	Maximum Reach (kft) Span 1	Maximum Reach (kft) Span 2 and Span 3	$\Omega$ per kft
26/0.4 mm	3.88	2.8	12	11.0	83
24/0.51 mm	2.84	2.0	16	15.0	52
22/0.61 mm	2.18	1.6	21	20.6	32
19/0.91 mm	1.54	1.1	29	27.8	16

(a) Insertion Loss = 1.5 times loop attenuation

# H4TU-C CARD-EDGE CONNECTOR

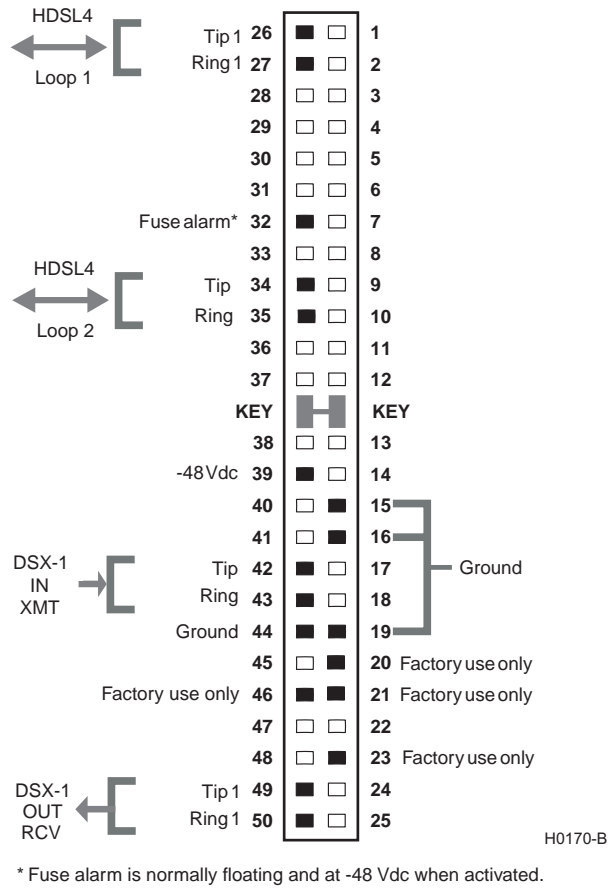

Figure 32. H4TU-C Card-Edge Connector

## Fuse Alarm

Figure 32 shows the pinout for the H4TU-C card-edge connector. Pin 32 on the card-edge connector is a Fuse Alarm that is driven to -48 Vdc whenever its onboard fuse opens.

# CRAFT PORT

Figure 33 shows the pinout for the craft port connector and its connection to a DB-9 or DB-25 connector on a maintenance terminal.

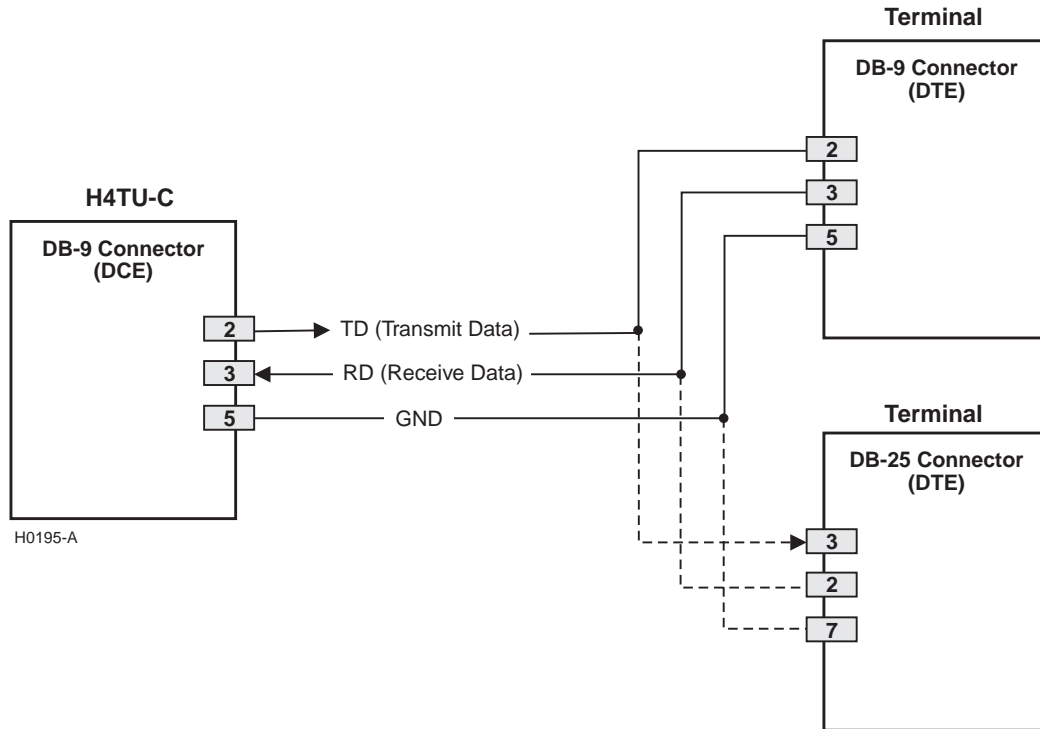

Figure 33. RS-232 Craft Port Pinouts



# APPENDIX B - FUNCTIONAL OPERATION

HDSL4 technology provides full-duplex services at standard T1 rates over two pairs of copper wire between an H4TU-C, H4Ds (if necessary), and an H4TU-R which comprise one ADC system. ADC systems use Overlapped Pulse Amplitude Modulation Transmission (OPAM) transceiver systems to establish two, full-duplex, 784 kbps data channels between the H4TU-C and a remotely located H4TU-R. This provides a total capacity of 1.568 Mbps between the two units.

A block diagram of the H4TU-C is shown in Figure 34. The H4TU-C receives a 1.544 Mbps DSX-1 data stream from the DSX-1 digital cross-connect interface. The H4TU-C contains a DS1 frame synchronizer controlled by an 8-bit microprocessor that determines the type of framing on the DS1 stream and synchronizes to it. The H4TU-C recognizes SuperFrame (SF), including D4, or Extended SuperFrame (ESF) framing. When the data is unframed, the H4TU-C arbitrarily defines a frame bit.

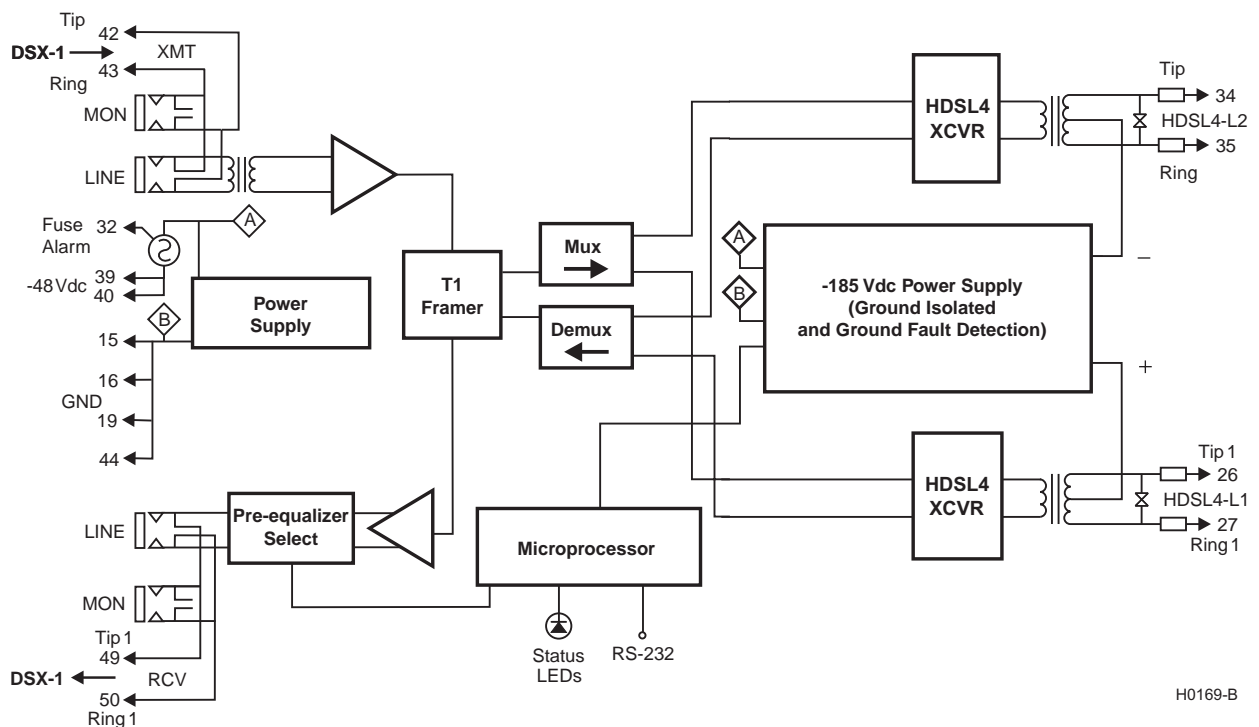

Figure 34. H4TU-C Block Diagram

## TIMING

The low loop wander (0.5 UI max) of an H4TU-C, when used with remote units, allows the circuit to be used in all critical timing applications, including those that are used to transport Stratum 1 timing.

## GROUND FAULT DETECTION

The H4TU-C has a Ground Fault Detection (GFD) circuit which detects a ground or a resistive path to ground on any wire of the HDSL4 loop. This makes the product compliant with the Class A2 requirements of GR-1089.

## SPECTRUM ISSUES

The asymmetric 776 kbps spectrum, defined in ANSI T1.418 Issue 2, allows the HDSL4 product to be spectrally compatible with ADSL services in adjacent pairs in the same binding groups for all non-doubler applications. A combination of asymmetric and symmetric spectrums is used for ADSL compatibility in doubler applications.

## COMPATIBILITY

The HiGain system uses HDSL4 transmission technology as recommended by ANSI committee in compliance with the ANSI T1.418-2000 HDSL4 standards. HiGain HDSL4 complies with GR-63-CORE, TR-TSY-000499, and GR-1089-CORE.

The H4TU-C is compatible with the following DS1 repeater shelves and associated equipment:

- ADC HiGain HCS-417 (23-inch shelf)
- ADC HiGain HCS-418 (19-inch shelf)
- ADC HiGain HCS-402 (2-slot)
- Lucent (ORB)
- Lucent (SXSS)
- Kentrox 220 (The ALM option must be Disabled (DIS) to resolve a conflict between the H2TU-C alarm relay output and the Kentrox external equalizer output. Both use pins 20 and 21.)
- Charles/Wescom 342-30

# APPENDIX C - PRODUCT SUPPORT

ADC Customer Service Group provides expert pre-sales and post-sales support and training for all its products. Technical support is available 24 hours a day, 7 days a week by contacting the ADC Technical Assistance Center.

## **Sales Assistance**

800.366.3891

- Quotation Proposals
- Ordering and Delivery
- General Product Information

## **Systems Integration**

800.366.3891

- Complete Solutions (from concept to installation)
- Network Design and Integration Testing
- System Turn-Up and Testing
- Network Monitoring (upstream or downstream)
- Power Monitoring and Remote Surveillance
- Service/Maintenance Agreements
- Systems Operation

## **ADC Technical Assistance Center**

800.366.3891

Email: [wsd\\_support@adc.com](mailto:wsd_support@adc.com)

- Technical Information
- System/Network Configuration
- Product Specification and Application
- Training (product-specific)
- Installation and Operation Assistance
- Troubleshooting and Repair/Field Assistance

## **Online Technical Support**

- [www.adc.com/Knowledge\\_Base/index.jsp](http://www.adc.com/Knowledge_Base/index.jsp)

## **Online Technical Publications**

- [www.adc.com/documentationlibrary/technicalpublications/](http://www.adc.com/documentationlibrary/technicalpublications/)

## **Product Return Department**

800.366.3891

Email: [rma@adc.com](mailto:rma@adc.com)

- ADC Return Material Authorization (RMA) number and instructions must be obtained before returning products.

All telephone numbers with an 800 prefix are toll-free in the USA and Canada.

# APPENDIX D - ABBREVIATIONS

## A

**ACO:** Alarm Cutoff  
**ADSL:** Asymmetric Digital Subscriber Line  
**AIS:** Alarm Indication Signal  
**ALM:** Alarm  
**ALMP:** Alarm Pattern  
**AMI:** Alternate Mark Inversion  
**AOR:** Addressable Office Repeater  
**ARM:** Armed  
**ASCII:** American Standard Code for Information Interchange  
**AWG:** American Wire Gauge

## B

**B8ZS:** Bipolar with 8-Zero Substitution  
**BER:** Bit Error Rate  
**BERT:** Bit Error Rate Tester  
**BPV:** Bipolar Violation  
**BPVT:** Bipolar Violation Transparency  
**BRG:** Bridge

## C

**CEV:** Controlled Environmental Vault  
**CI:** Customer Installation  
**CLEI:** Common Language Equipment Identifier  
**CLOC:** Customer Local Loopback  
**CO:** Central Office  
**COLB:** Central Office Loopback  
**CPE:** Customer Premises Equipment  
**CRC:** Cyclical Redundancy Check  
**CREM:** Customer Remote Loopback  
**CSA:** Carrier Service Area  
**CV:** Code Violation  
**CV-L:** Code Violation - Line  
**CV-P:** Code Violation - Path

## D

**DBER:** DS1 Bit Error Rate  
**DL:** Data Link  
**DLC:** Digital Loop Carrier  
**DS1:** Digital Signal, Level 1  
**DSX-1:** Digital Signal Cross-Connect, Level 1

## E

**ECI:** Equipment Catalog Item  
**EQL:** Equalization  
**ESD:** Electrostatic Discharge  
**ESF:** Extended SuperFrame  
**ES-L:** Errored Seconds - Line  
**ES-P:** Errored Seconds - Path

## F

**FE:** Far End  
**FRMG:** Framing

## H

**H4TU-C:** HDSL4 Line Unit  
**H4TU-R:** HDSL4 Remote Unit  
**HBER:** HDSL4 Block Error Rate  
**HCDS:** High Capacity Digital Service  
**HDSL:** High-bit-rate Digital Subscriber Line  
**HG:** HDSL Generic  
**HMU:** HiGain Management Unit

## I

**ID:** Identification  
**ILR:** Intelligent Repeater Loop  
**IN:** Transmit  
**INSL:** Insertion Loss  
**IOR:** Intelligent Office Repeater

## L

**LA:** Loop Attenuation

**LAIS:** Line Alarm Indication Signal  
**LATT:** Loop Attenuation  
**LBPV:** Local Bipolar Violation  
**LBTO:** Loopback Timeout  
**LED:** Light Emitting Diode  
**LLOS:** Line (Unit) Loss of Signal  
**LOF:** Loss of Frame  
**LOSW:** Loss of Sync Word  
**LPDN:** Loopdown  
**LPF:** Line Power Feed  
**LRAI:** Line (Clear) Remote Alarm Indication

**M**

**M:** HDSL4 Margin  
**MAL:** Margin Alarm  
**MARG:** Margin  
**MNGD:** Managed  
**MSEC:** Monitored Seconds

**N**

**NE:** Near End  
**NI:** Network Interface  
**NID:** Network Interface Device  
**NLBP:** Network Loopback Pattern  
**NLOC:** Network Local Loopback  
**NMA:** Network Management and Administration  
**NREM:** Network Remote Loopback

**O**

**OPAM:** Overlapped Pulse Amplitude Modulation  
**OUT:** Receive

**P**

**PBOC:** Power Back Off - Customer  
**PBON:** Power Back Off - Network  
**PL:** Payload  
**POTS:** Plain Old Telephone Service  
**PRM:** Performance Report Messaging  
**PRM-FE:** Performance Report Messaging - Far End

**PWRF:** Power Feed

**R**

**RAI:** Remote Alarm Indication  
**RAIS:** Remote Alarm Indication Signal  
**RDA:** Remote Disconnect Alarm  
**RLOS:** Remote (Unit) Loss of Signal  
**RRAI:** Remote RAI  
**RTPV:** Remote Provisioning  
**RULB:** Remote Unit Loopback

**S**

**S/N:** Signal-to-Noise Ratio  
**SDSL:** Symmetrical Digital Subscriber Line  
**SES:** Severely Errored Seconds  
**SES-L:** Severely Errored Seconds - Line  
**SES-P:** Severely Errored Seconds - Path  
**SF:** SuperFrame  
**SMJK:** SmartJack

**T**

**TLOS:** Transmit Loss of Signal

**U**

**UAS :** Unavailable Seconds  
**UAS-L:** Unavailable Seconds - Line  
**UAS-P:** Unavailable Seconds - Path  
**UNFR:** Unframed



---

# CERTIFICATION AND WARRANTY

## FCC CLASS A COMPLIANCE

This equipment has been tested and found to comply with the limits for a Class A digital device, pursuant to Part 15 of the FCC Rules. These limits are designed to provide reasonable protection against harmful interference when the equipment is operated in a commercial environment. This equipment generates, uses, and can radiate radio frequency energy and, if not installed and used in accordance with the instruction manual, may cause harmful interference to radio communications. Operation of this equipment in a residential area is likely to cause harmful interference in which case the user will be required to correct the interference at his own expense.

## LIMITED WARRANTY

Product warranty is determined by your service agreement. Contact your sales representative or Customer Service for details.

## MODIFICATIONS

Any changes or modifications made to this device that are not expressly approved by ADC DSL Systems, Inc. voids the user's warranty. All wiring external to the products should follow the provisions of the current edition of the National Electrical Code.

## SAFETY STANDARDS COMPLIANCE

The equipment has been tested and verified to comply with the applicable sections of the following standards:

- GR 63-CORE - Network Equipment-Building System (NEBS) Requirements
- GR 1089-CORE - Electromagnetic Compatibility and Electrical Safety
- Binational standard, : Safety of Information Technology Equipment

For technical assistance, refer to [“Appendix C - Product Support”](#) on page 59.

---

**World Headquarters**

ADC Telecommunications, Inc.  
PO Box 1101  
Minneapolis, MN 55440-1101 USA

**For Technical Assistance**

Tel: 800.366.3891

DOCUMENT: LTPH-UM-1253-01



1267600