

WORLDDSL

USER MANUAL

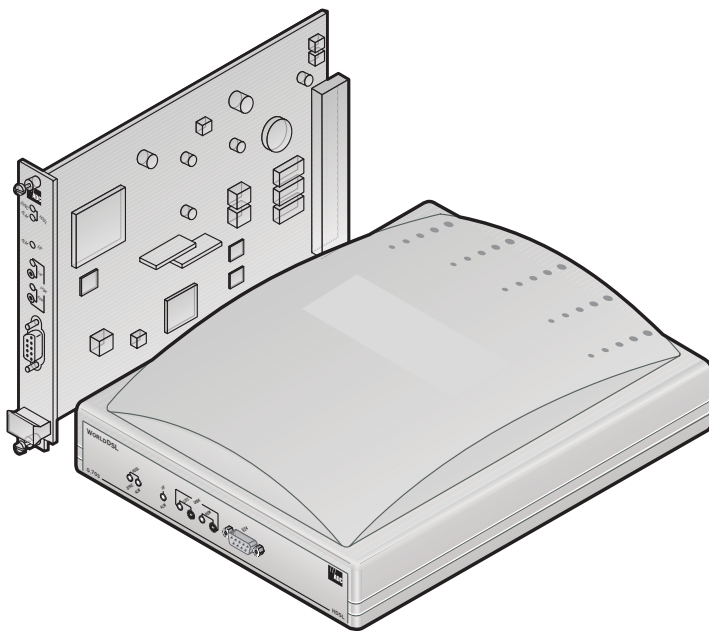

Rate Selectable HDSL Line and Desktop Units

UTU-702C List 1
Universal Termination Unit
Part Number: 150-1422-02C

ETU-752C List 1
ETSI Termination Unit
Part Number: 150-1432-12C



Revision History of This Manual

Revision	Release Date	Revisions Made
01	May 10, 1999	Initial Release
02	August 30, 2002	ADC Rebrand

Copyright

May 10, 1999

© 1999 ADC DSL Systems, Inc. All rights reserved.

Trademark Information

ADC and Soneplex are registered trademarks and WorldDSL is a trademark of ADC Telecommunications, Inc. HiGain is a registered trademark of ADC DSL Systems, Inc. No right, license, or interest to such trademarks is granted hereunder, and you agree that no such right, license, or interest shall be asserted by you with respect to such trademark.

Other product names mentioned in this document are used for identification purposes only and may be trademarks or registered trademarks of their respective companies.

Disclaimer of Liability

Information contained in this document is company private to ADC DSL Systems, Inc., and shall not be modified, used, copied, reproduced or disclosed in whole or in part without the written consent of ADC.

Contents herein are current as of the date of publication. ADC reserves the right to change the contents without prior notice. In no event shall ADC be liable for any damages resulting from loss of data, loss of use, or loss of profits, and ADC further disclaims any and all liability for indirect, incidental, special, consequential or other similar damages. This disclaimer of liability applies to all products, publications and services during and after the warranty period.

USING THIS TECHNICAL PRACTICE

Two types of messages, identified by icons, appear in the text.



Notes contain information about special circumstances.



Cautions indicate the possibility of equipment damage or the possibility of personal injury.

Warnungszeichen deuten darauf hin, dass Schaden am Gerät oder eine mögliche Körperverletzung riskiert wird, falls die Warnungen nicht beachtet werden.

TABLE OF CONTENTS

Overview	1
Rate Selectable HDSL Unit Firmware.....	1
EMU Firmware Compatibility	2
Application Interface.....	2
HDSL Technology	3
Transmission Ranges	3
Front and Rear Panel Components.....	4
WorldDSL Product Compatibility	8
Specifications	9
Functional Description	11
Major Components.....	11
Nx64k Serial Data Port.....	12
HDSL Interface.....	12
System Timing Circuits	12
Processor.....	13
On-Board Power Supply Modules.....	14
Single Pair Rate Selectable Applications.....	14
Hot Swapping.....	15
Performance Monitoring and History	15
Alarms.....	16
Loopbacks	16
BER Testing	18
Inspection, Safety, and Equipment Repair	19
Inspection.....	19
Safety	19
Equipment Repair	19
Installation and Startup	20
UTU-702C Line Unit Installation	20
ETU-752C Desktop Unit Installation	21
HDSL Startup and Synchronization.....	21
System Configuration	22
Maintenance Terminal Connection.....	22
Modem Connection.....	23
Logging On	24
Console Screen Menu Structure.....	25
Reading and Navigating Menus.....	27

Config Menu Options	29
Configure Terminal Settings	30
Configure Date and Time	31
Change Password	32
Configure Circuit ID	33
Configure System Settings	34
Configure LTU and NTU Interfaces	36
Configure Alarms	38
Set to Factory Defaults	41
Logging Off	42
Viewing Status	43
Main Console Screen	43
Monitor Menu	45
Monitor LTU Interface Screen	46
Monitor NTU Interface Screen	47
Monitor HDSL Span 1 Screen	48
History Menu	49
History LTU and NTU Interface Screens	50
HDSL Span Performance History Screens	52
Clear History Screens	55
Inventory Screen	55
Testing	57
Firmware Download Utility	59
Reference Information	61
ETU-752C Connector Pinouts	61
ECA-800 Connector Adapter (DB25M to M34F for V.35)	62
ECA-801 Connector Adapter (DB25M to DB15F for X.21)	63
ECA-802 Connector Adapter (DB9M to RJ-45)	64
ECA-804 Connector Adapter (DB9M to Four-Position Terminal Block)	65
Product Support	66
Abbreviations	67
Certification and Warranty	Inside Back Cover

LIST OF FIGURES

1. Transport of Customer Video Service to an Nx64k Serial Network	2
2. UTU-702C Line Unit Front Panel	4
3. ETU-752C Desktop Unit Front Panel.....	4
4. ETU-752C Desktop Unit Rear Panel.....	7
5. Line and Desktop Unit Functional Block Diagram	11
6. Transmission of Serial Data in Manual Mode and Nx64k Auto Mode ^c	12
7. Data Port Transmit Timing	13
8. Single Pair Rate Selectable HDSL Video Conferencing Application	14
9. Single Pair Rate Selectable HDSL Frame Relay Application	15
10. Loopback Operations	17
11. Installing the UTU-702C Line Unit.....	20
12. UTU/ETU Console Port and Maintenance Terminal Connector Pinouts.....	22
13. Connecting a Maintenance Terminal to a Line Unit.....	23
14. Logon Password Screen.....	24
15. Console Screen Menu Bar	24
16. Console Screen Menu Structure	25
17. Items in Console Screen Status Bar.....	27
18. Console Screen Config Menu	29
19. Config Terminal Settings Menu	30
20. Config Date and Time Menu	31
21. Config Change Password Menu	32
22. Config Circuit ID Menu.....	33
23. Config System Settings Menu	34
24. Config LTU Interface Menu	36
25. Config NTU Interface Menu.....	36
26. Config Alarms Menu	38
27. Config Alarms LTU Interface Menu	39
28. Config Alarms NTU Interface Menu.....	39
29. Config Alarms HDSL Span 1 Menu.....	40
30. Set to Factory Defaults Screen.....	41
31. Main Console Screen	43
32. Monitor Menu	45
33. Monitor LTU Interface Screen	46
34. Monitor NTU Interface Screen	47
35. Monitor HDSL Span 1 Screen	48
36. History Menu	49

37. History LTU Interface Menu.....	50
38. History NTU Interface Menu	50
39. LTU Interface Alarm History Screen.....	51
40. History HDSL Span 1 Menu	52
41. 24 Hour History Screen for HDSL Span 1.....	52
42. 7 Day History Status Screen for HDSL Span 1	53
43. Alarm History Status Screen for HDSL Span 1	54
44. Inventory Screen	55
45. Test Menu Screen.....	57
46. ETSI Firmware Download Utility Menu	59
47. ECA-800 DB25M to M34F (V.35) Connector Adapter, Part Number 150-1470-01	62
48. ECA-801 D25M to DB15F (X.21) Connector Adapter, Part Number 150-1470-01	63
49. ECA-802 DB9M to RJ-45 Connector Adapter, Part Number 150-1472-01	64
50. ECA-804 DB9M to Four-Position Terminal Block Connector Adapter, Part Number 150-1474-01	65

LIST OF TABLES

1. Rate Selectable HDSL Unit Characteristics	2
2. Transmission Ranges with ETSI Noise	3
3. Line and Desktop Unit Front Panel Components	5
4. Line and Desktop Unit Front Panel LED Indications	6
5. ETU-752C Desktop Unit Rear-Panel Components	7
6. WorldDSL Product Compatibility	8
7. Monitored HDSL Transmission and Interface Performance Parameters	15
8. HDSL Transmission and Application Interface Alarms	16
9. Loopbacks Selected at Front Panel Pushbuttons and Console Screens	17
10. Loopback Equivalents.....	18
11. Console Screen Menus.....	26
12. Console Screen Status Bar Displays	27
13. Console Screen Navigation Keys	28
14. Config Menu Options and Recommended Order of System Configuration.....	29
15. Fields and Options in Config System Settings Menu	35
16. Fields and Options in Config LTU and Config NTU Interface Menus	37
17. V.35/V.36/X.21 Output Control Signal Operation	37
18. Fields in Config Alarms LTU and Config Alarms NTU Interface Menus	40
19. Fields in Config Alarms HDSL Span 1 Menu	41
20. Factory Default System Settings.....	42
21. Reading the Main Console Screen.....	43
22. Fields in Main Console Screen	44
23. Fields in Monitor LTU and Monitor NTU Interface Screens	46
24. Fields in Monitor HDSL Span 1 Screen	48
25. LTU Interface and NTU Interface Alarm History Data.....	51
26. HDSL Span Alarm History Data	54
27. Inventory Screen Data	56
28. Test Menu Options.....	58
29. BER Section of Test Menu	58
30. ETSI Firmware User Selectable Download Menu Options	60
31. Navigating the ETSI Firmware Download Menu.....	60
32. D9F HDSL Line Connector Pinouts	61
33. D25F Data Port Connector Pinouts	61
34. ECA-800 DB25M to M34F (V.35) Connector Adapter Pinouts	62
35. ECA-801 DB25M to DB15F (X.21) Connector Adapter Pinouts	63
36. ECA-802 DB9M to RJ-45 Connector Adapter Pinouts.....	64
37. ECA-804 DB9M to Four-Position Terminal Block Connector Adapter Pinouts	65

OVERVIEW

ADC® WorldDSL™ offers High-bit-rate Digital Subscriber Line (HDSL) Line Termination Units (LTUs), Network Termination Units (NTUs), Universal Termination Units (UTUs), and ETSI Termination Units (ETUs). The units are shelf and enclosure mounted, providing full-duplex transmission of up to 2.048 Mbps data over one or two twisted pairs of copper wire. Public carriers and private network providers can use these units to offer low-cost service with fiber-optic quality using the local copper loop without installing repeaters or conditioning the outside plant. The units comply with European Telecommunication Standards Institute (ETSI) specifications ETR152 and TS 101 135 for this type of system.

This practice describes the ADC WorldDSL RS UTU-702C List 1 and ETU-752C List 1 Rate Selectable HDSL line and desktop units. The terms for these units are defined as follows:

- LTU and NTU are defined by the European Telecommunication Standards Institute (ETSI) to distinguish between the two units in an HDSL system. An LTU is generally located at the Exchange Office end of the circuit and acts as the master unit. The NTU is located at the customer site and acts as the slave unit.
- UTU is defined by ADC. These are programmable HDSL line units that can be configured as an LTU (master) or an NTU (slave). The UTU default configuration is NTU (slave). The UTUs do not provide line power to other HDSL units. All other aspects of UTU functionality are identical to LTUs or NTUs. The UTU-702C has an Nx64k interface and must be locally powered from a -36 Vdc to -72 Vdc power supply.
- ETU is defined by ADC. These are programmable HDSL line units housed in plastic enclosures with interface and power connectors for convenient use as integrated desktop units. The ETUs can be configured as an LTU or an NTU. The ETU default configuration is NTU. The ETU-752C does not provide or receive line power; it must be locally powered. All other aspects of ETU functionality are identical to LTUs or NTUs. The ETU-752C has an Nx64k interface and contains a power supply that accepts 100 to 240 volt, 50 or 60 Hz, AC power.
- WorldDSL RS (rate selectable) is defined by ADC. WorldDSL RS is a single pair High-bit-rate Digital Subscriber Line (HDSL) solution that offers extended reach capabilities through the use of industry-leading multi-rate DSL technology. The UTU-702C and ETU-752C deploy HDSL in networks using a single pair of copper wire running at speeds between 64 kbps and 2.048 Mbps. The HDSL line rates are either menu selected in time slot increments of 64 kbps or derived automatically from the Terminal Transmission (TT) clock received at the Nx64k serial data port from the Network Data Terminal Equipment (DTE). Transmission ranges vary according to the rate selected. Depending on noise environment, ranges of up to 8.5 km (5.3 miles) are possible at the lowest-selectable HDSL line rates (64 and 128 kbps).

These HDSL units are configured as Data Communications Equipment (DCE) and respond to data, clock, and control signals from Data Terminal Equipment (DTE).



Unless otherwise specified:

- LTU refers to an LTU-configured UTU or ETU.
- NTU refers to an NTU-configured UTU or ETU.
- The term “line and desktop units” refers to UTUs and ETUs, respectively.

RATE SELECTABLE HDSL UNIT FIRMWARE

Version 4.0 is the current rate selectable HDSL unit firmware release.



Rate selectable units are not backward compatible with standard HDSL or management unit firmware. The installed firmware must be designed for rate selectable units.

Rate selectable units must have the same payload rates available. An LTU set for a rate of 768 kbps will not function with an NTU whose maximum available rate is 256 kbps.

EMU FIRMWARE COMPATIBILITY

The EMU-830 Management Unit firmware must be Version 3.30 or later to support rate selectable HDSL units.

APPLICATION INTERFACE

The application interface is a synchronous serial data port with two modes of operation, Manual and Nx64k Auto.

In the Nx64k Auto mode, the HDSL payload rate is determined by the frequency of the TT clock received at the Nx64k data port of the LTU-configured unit. In the Manual mode, the HDSL payload rate is user selected from the LTU console screen. The total available payload rate of 2.048 Mbps can be user selected in increments of 64 kbps. Each 64 kbps increment represents one time slot.

Time slots are mapped to the HDSL framer according to either the input clock frequency at the Nx64k data port (Nx64k Auto mode) or the rate selection made from the LTU console screen (Manual mode). The time slot configuration (HDSL rate) applied to the LTU determines the HDSL rate at the remote NTU.

The Nx64k serial data interface complies with the V.35, V.36, X.21, or RS-530 (RS-449) standard based on the selection from the console screen menus.

Table 1 lists the characteristics of the rate selectable HDSL line and desktop units covered in this practice.

Figure 1 illustrates an application of a single-pair Nx64k interface where video service is transported from the customer to an Nx64k serial network.

Table 1. Rate Selectable HDSL Unit Characteristics

Model	Interface	Selectable HDSL Rates (kbps)	LTU/NTU Configurable
UTU-702C	Nx64k	64 to 2048	Yes
ETU-752C	Nx64k	64 to 2048	Yes



See “Functional Description” on page 11 for more information on the Nx64k interface.

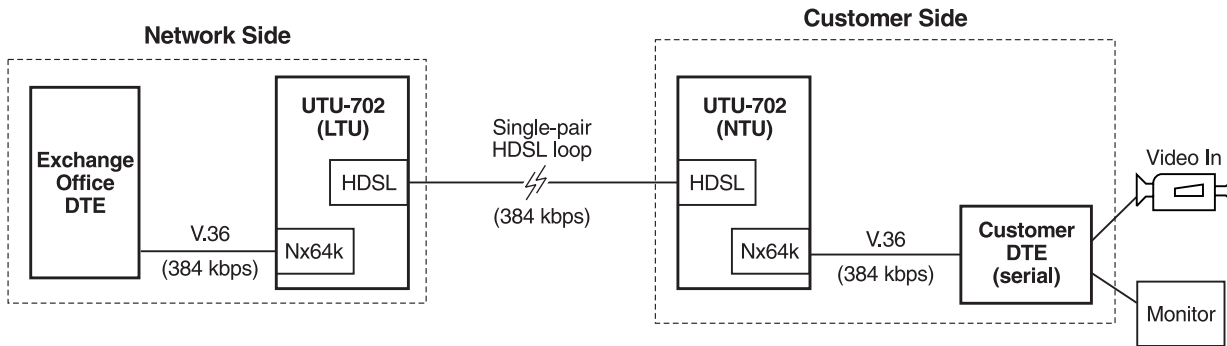

Figure 1. Transport of Customer Video Service to an Nx64k Serial Network

HDSL TECHNOLOGY

HDSL is the core technology for ADC's WorldDSL line of LTUs, UTUs, and ETUs. Rate selectable HDSL enables these units to transmit and receive digital data at various rates over various distances on one twisted-pair of copper wire. Both outbound and inbound signals are delivered on the same pair of wires by using echo cancellation techniques. The transmitted signal is canceled at the receiver by precisely predicting the amount of signal echo, then subtracting it from the overall input signal. ADC's market leading HDSL-based products tolerate crosstalk, and operate not only on continuous unobstructed pairs of wires, but also on cables with mixed wire gauges and bridged taps.

TRANSMISSION RANGES

Transmission ranges assume the presence of noise according to the ETSI model described in TS 101 135. The expected Bit Error Rate (BER) under this model is 1×10^{-7} . The transmission ranges in such a noise environment at the various HDSL line rates over one twisted-pair of 0.4 mm and 0.51 mm copper wire are listed in [Table 2](#). The no noise transmission ranges are listed in "[Specifications](#)" on [page 9](#).

Table 2. *Transmission Ranges with ETSI Noise*

HDSL Line Rate (kbps) ^(a)	Wire Size and Transmission Range (with ETSI Noise)	
	0.4 mm (26 AWG) Single Twisted-Pair Copper Wire	0.51 mm (24 AWG) Single Twisted-Pair Copper Wire
128	5.0 km (16,404 ft.)	6.3 km (20,669 ft.)
256	4.1 km (13,451 ft.)	5.1 km (16,732 ft.)
384	3.9 km (12,795 ft.)	4.7 km (15,420 ft.)
512	3.5 km (11,483 ft.)	4.5 km (14,764 ft.)
768	3.2 km (10,499 ft.)	4.2 km (13,779 ft.)
1152	2.6 km (8,530 ft.)	3.4 km (11,155 ft.)
1536	2.2 km (7,218 ft.)	2.9 km (9,514 ft.)
2048	1.9 km (6,234 ft.)	2.4 km (7,874 ft.)

(a) A selected HDSL line rate of 64 kbps is transmitted at 128 kbps.

FRONT AND REAR PANEL COMPONENTS

The line and desktop unit front panels are shown in Figure 2 and Figure 3, respectively. The components on these panels are described in Table 3 on page 5 and in Table 4 on page 6.

The ETU-752C desktop unit rear panel is shown in Figure 4 on page 7. The components on this panel are described in Table 5 on page 7. The pinouts for the desktop unit rear panel connectors are listed in Table 32 and Table 33 on page 61.

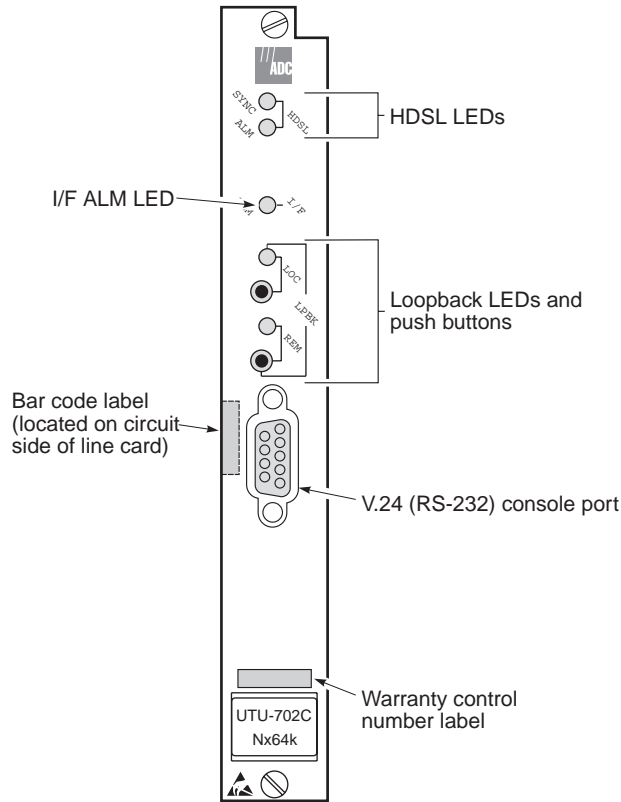

Figure 2. UTU-702C Line Unit Front Panel

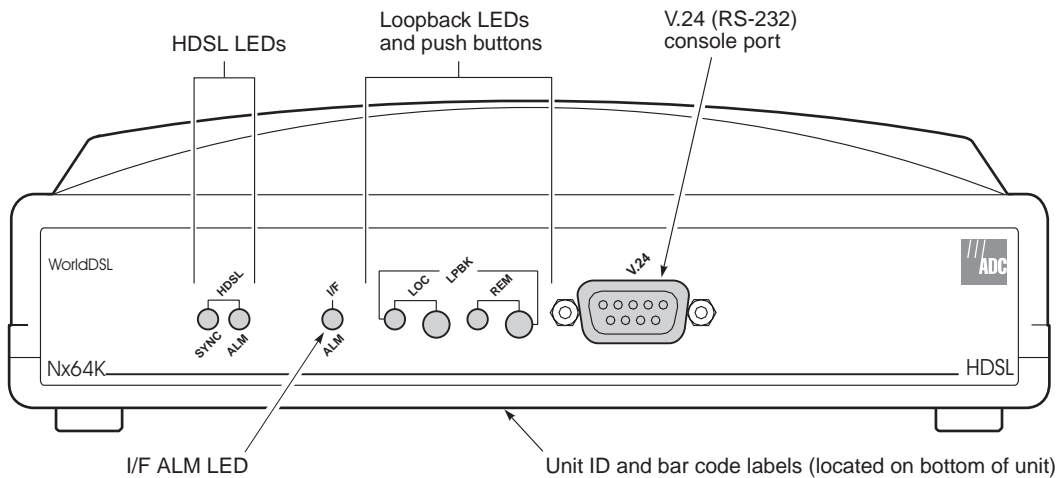

Figure 3. ETU-752C Desktop Unit Front Panel

Table 3. Line and Desktop Unit Front Panel Components

Name	Function
HDSL SYNC LED	Displays synchronization state for the HDSL loop.
HDSL ALM LED	Displays alarm state for the HDSL loop.
I/F ALM LED	Displays alarm state for the Nx64k serial data port.
LOC LPBK LED	Displays local (LOC) loopback state.
LOC LPBK Button	Activates the local HDSL analog loopback.
REM LPBK LED	Displays remote (REM) loopback state.
REM LPBK Button	Activates the remote interface loopback.
V.24 (RS-232) console port	Provides bi-directional communication between the unit and an external maintenance terminal through a V.24 (RS-232C) interface to allow configuration and performance monitoring through the console screen menus as described in “System Configuration” on page 22 . This connector can also be used to download new firmware to the line unit’s flash memory as described in “Firmware Download Utility” on page 59 . This port is configured as DCE (see “Maintenance Terminal Connection” on page 22 for pinouts).
Bar code label (all units)	Contains the serial number and part number of the unit, as indicated in both bar code and text format. Also contains the configuration number of the unit, as indicated by "CFG: Rnn," where <i>nn</i> is the configuration number. For example, CFG: R07 would indicate configuration number 07.
Warranty control number label (UTU-702C)	Indicates the beginning year and month of the line card warranty. Also indicates the line card revision number. For example, a warranty control number of "803R07" would indicate a warranty beginning in the year 1998 (8), during the month of March (03), and line card revision number R07.
Unit ID label (ETU-752C)	Identifies the model number, manufacturer, part number, and input voltage range of the ETU.

Table 4 defines the system states indicated by the front panel LEDs. When power is applied to the unit, one of the LEDs listed in Table 4 will always be on.

Table 4. *Line and Desktop Unit Front Panel LED Indications*

LED	Mode		Description
HDSL SYNC LED	Steady green		HDSL loop is ready to transmit and receive data across all spans.
	Slow blinking		HDSL loop acquisition is in progress for local span.
	Off		HDSL loop is not configured.
HDSL ALM LED	Steady red		Loss of sync word (LOSW); or the margin is below the set margin alarm threshold; or Errored Seconds (ES) count is above threshold on any span.
	Pulsing red		Pulses for every ES on any span.
	Off		Normal transmit or receive data is in progress.
I/F ALM LED	Steady red		Loss of Clock (LOC) alarm due to loss of TT clock (Nx64k timing) or external clock (EXT timing).
LPBK LEDs ^(a)	LOC	REM	
	Steady yellow	Off	Local HDSL analog loopback is active.
	Off	Off	No loopbacks are active.
	Blinking yellow	Off	Local interface loopback is active.
	Off	Steady yellow	Remote loopback is active.
Blinking yellow	Blinking yellow	A loopback away from the local equipment is active.	

(a) The LOC and REM LPBK LEDs are read in unison.

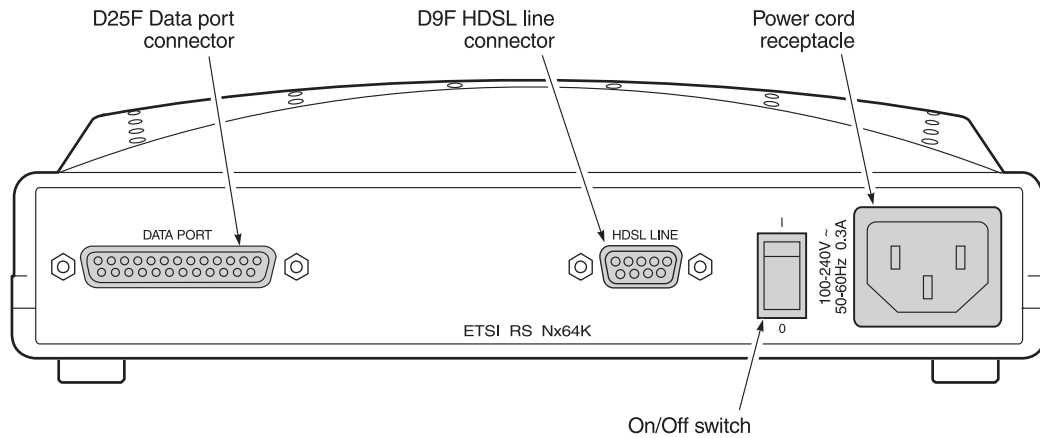

Figure 4. ETU-752C Desktop Unit Rear Panel

Table 5. ETU-752C Desktop Unit Rear-Panel Components

Item	Description
D25F data port connector	Connects Nx64k data circuits to the enclosure. See Table 33 on page 61 for the D25F data port connector pinouts.
D9F HDSL line connector	Connects the HDSL pairs to the enclosure. See Table 32 on page 61 for the D9F HDSL line connector pinouts.
Power cord receptacle	Connects an AC power cord to the enclosure.
On/Off switch	Rocker switch that allows you to turn the externally applied AC power on or off.

WORLDDSL PRODUCT COMPATIBILITY

The line and desktop units are compatible with the ADC WorldDSL products listed in [Table 6](#).

Table 6. *WorldDSL Product Compatibility*

Model	Description	Part Number
Rate Selectable HDSL Units		
UTU-712	Rate Selectable HDSL Line Unit, 64 to 768 kbps HDSL Line Rate	150-1422-12
UTU-722	Rate Selectable HDSL Line Unit, 64 to 256 kbps HDSL Line Rate	150-1422-22
ETU-762	Rate Selectable HDSL Desktop Unit, 64 to 768 kbps HDSL Line Rate	150-1432-12
ETU-772	Rate Selectable HDSL Desktop Unit, 64 to 256 kbps HDSL Line Rate	150-1432-22
Management Units		
EMU-830	Exchange office Management Unit List 1	150-1440-01
EMU-830	Exchange office Management Unit List 3	150-1440-03
Shelves and Enclosures for UTU-702C		
EMS-830	Exchange office Management Shelf, rear connector access	150-1400-01
EMS-831	Exchange office Management Shelf, front connector access	150-1401-01
EMS-832	Exchange office Management Shelf, front connector access	150-1402-01
ERE-810	Single slot remote enclosure	150-1410-01
ERE-811	Single slot remote enclosure with internal AC power supply	150-1411-01
ERE-821	Dual-slot enclosure with internal AC power supply	150-1416-01
ERE-826	Single slot remote enclosure	150-1412-01
Connector Adapters for ETU-752C		
ECA-800	D25M to M34F connector adapter (V.35)	150-1470-01
ECA-801	D25M to D15F connector adapter (X.21)	150-1471-01
ECA-802	DB9M to RJ-45 connector adapter (HDSL)	150-1472-01
ECA-804	DB9M to 4-position terminal block connector (HDSL)	150-1474-01
ECA-807	DB25M to DB37F connector adapter (RS-449)	150-1477-01



The ECA-80x series of connector adapters and their pinouts are listed in [Table 34](#) through [Table 37](#), beginning on [page 62](#).

SPECIFICATIONS

HDSL Interface

Line Code	2B1Q
Line Rate (selectable in increments of 64 kbps)	Up to 2048 kbps
Protection	K.20, K.21
Compliance	TS 101 135
Transmission Ranges (± 200 m):	

HDSL Line Rate (kbps)	Transmission Ranges with ETSI Noise		Transmission Ranges with No Noise	
	0.4 mm (26 AWG) Single Twisted-Pair Copper Wire	0.51 mm (24 AWG) Single Twisted-Pair Copper Wire	0.4 mm (26 AWG) Single Twisted-Pair Copper Wire	0.51 mm (24 AWG) Single Twisted-Pair Copper Wire
128	5.0 km (16,404 ft.)	6.3 km (20,669 ft.)	6.1 km (20,013 ft.)	8.5 km (27,887 ft.)
256	4.1 km (13,451 ft.)	5.1 km (16,732 ft.)	5.4 km (17,716 ft.)	7.1 km (23,293 ft.)
384	3.9 km (12,795 ft.)	4.7 km (15,420 ft.)	5.2 km (17,060 ft.)	6.7 km (21,982 ft.)
512	3.5 km (11,483 ft.)	4.5 km (14,764 ft.)	4.6 km (15,092 ft.)	6.3 km (20,669 ft.)
768	3.2 km (10,499 ft.)	4.2 km (13,779 ft.)	4.3 km (14,108 ft.)	5.9 km (19,357 ft.)
1152	2.6 km (8,530 ft.)	3.4 km (11,155 ft.)	3.9 km (12,795 ft.)	5.2 km (17,060 ft.)
1536	2.2 km (7,218 ft.)	2.9 km (9,514 ft.)	3.4 km (11,155 ft.)	4.7 km (15,420 ft.)
2048	1.9 km (6,234 ft.)	2.4 km (7,874 ft.)	3.0 km (9,842 ft.)	3.2 km (10,499 ft.)

Nx64k Serial Data Interface

Type	V.35, V.36, X.21, or RS-530 (RS-449)
Fractional	Nx64 kbps (where N equals 1 to 32)
Maximum Rate	2048 kbps
Control Signals	Request to Send (RTS) Data Terminal Ready (DTR) Local Loopback (LL) Remote Loopback (RL) Clear to Send (CTS) Data Set Ready (DSR) Received Line Signal Detector (RLSD) Test mode (TM)
Compliance	NET 2

Timing

Clock Source	Nx64k data port input clock, HDSL recovered clock, Internal Oscillator
Internal Oscillator	2.048 MHz \pm 50 ppm

Performance Monitoring and Diagnostics

HDSL	Noise margin, pulse attenuation, ES, UAS
Major Alarm Relay (UTU-702C only)	Form-C relay contacts (NO, NC, C). Fail-safe operation
Loopbacks	Local interface loopback, local HDSL loopback, remote loopback

Alarms

Can be individually set to Disabled, Minor, or Major (major alarms actuate the UTU-702C alarm relay)

Serial Dataport Interface	Loss of Clock (LOC)
External Clock	Loss of Clock (LOC)
HDSL	Margin, programmable threshold (MAR) Errored Seconds, programmable threshold (ES) Loss of Sync Word (LOSW)

History

HDSL Interface	24-Hour (15-minute intervals) and 7-Day (24-hour intervals) for ES and Unavailable Seconds (UAS)
Alarm	Time stamp of first and last occurrence, number of occurrences for all enabled alarms

Power Requirements

UTU-702C	
Local input voltage	-36 Vdc to -72 Vdc
Consumption (typical)	6 W
ETU-752C	
Local input voltage	100 to 240 volt, 50 or 60 Hz, AC power
Consumption (typical)	6 W

Environmental

Operating Temperature Range	0° C to +50° C
Humidity	Up to 95% non-condensing
Storage Temperature	-40° C to +70° C
Storage Humidity	5% to 95% non-condensing

Regulatory Approvals

Safety	EN 41003, EN 60950
EMC/EMI	EN 55022, EN 50082-1 (IEC 801-2/3/4), EN 61000-3-2

FUNCTIONAL DESCRIPTION

This section provides a functional description of the line and desktop units, including major components, single-pair application mode, alarms, and testing (including monitoring and loopbacks).

MAJOR COMPONENTS

The major components of the line and desktop units include:

- Nx64k serial data port (V.35, V.36, X.21, or RS-530)
- high-speed, rate selectable HDSL interface (including framing, transceiver, and line interface circuits)
- system timing circuits
- processor
- on-board power supply modules.

Figure 5 shows a functional block diagram of the line and desktop units.

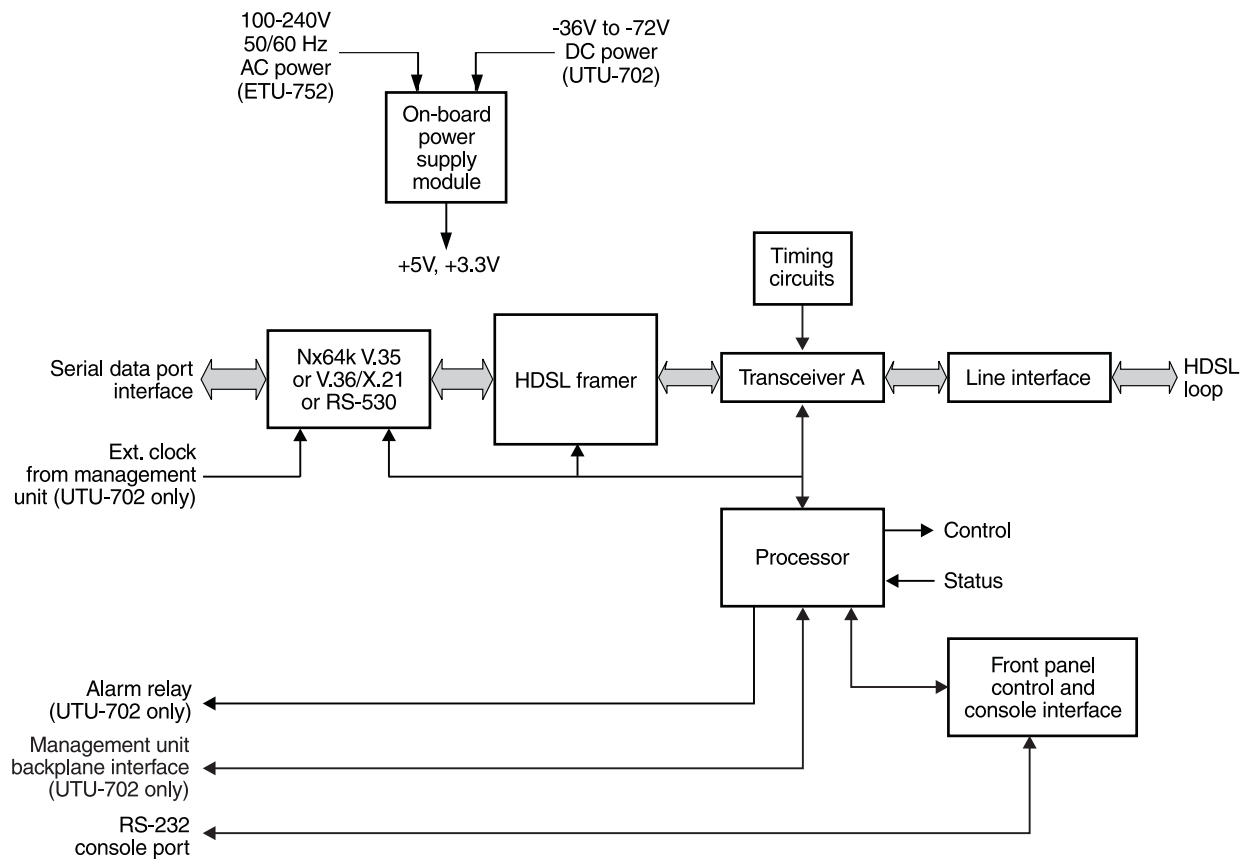

Figure 5. Line and Desktop Unit Functional Block Diagram

Nx64k Serial Data Port

In the Nx64k Auto mode, the LTU sets the HDSL line rate to the frequency of the TT clock received at its Nx64k serial data port. In the Manual mode, the LTU sets the HDSL line rate to the frequency selected in the LTU console screen. The TT clocks at the Network DTE and Customer DTE must be set to match the Manual mode selection. In Nx64k Auto mode, the TT clock at the Customer DTE must be set to match the TT clock at the Network DTE. [Figure 6](#) further defines each mode of serial data transmission. See “[System Configuration](#)” on [page 22](#) for more information on selecting the Manual and Nx64k Auto modes.

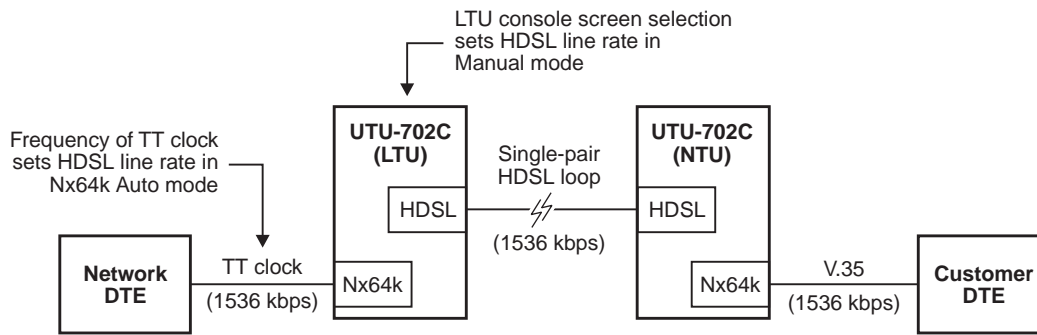

Figure 6. *Transmission of Serial Data in Manual Mode and Nx64k Auto Mode*

The line units provide a V.35, V.36, X.21, or RS-530 compliant connection at the serial data port connector (referred to as interface type). The appropriate interface type is configured as described in “[System Configuration](#)” on [page 22](#). ADC offers V.35 and X.21 connector adapters (ECA-800 and ECA-801, respectively) to convert the D25F data port connector on the shelves and enclosures to standard V.35 (M34F) and X.21 (D15F) connectors (see “[Reference Information](#)” on [page 61](#)).

Line units are always configured as DCE. Output control signals (CTS, DSR, RLSD) follow the interface standard or may be forced ON or OFF using the console screen menus. The HDSL cards can be set to respond to or ignore the input control signals, Local Loopback (LL) and Remote Loopback (RL), for loopback activation.

HDSL Interface

The HDSL interface includes the HDSL framer, which performs HDSL multiplexing and demultiplexing functions, the transceiver and line interface circuit for the single HDSL pair, and a firmware-controlled programmable clock, which sets the HDSL line rate at the interface output.

In the transmit direction, the HDSL framer accepts inputs from the serial data port as shown in [Figure 5](#). The data is placed on the HDSL pair along with the HDSL overhead bits for presentation to the transceiver. A clock representing the selected HDSL line rate is introduced to the transceiver, which outputs data on the single-pair HDSL line. In the HDSL receive direction, overhead bits are stripped and processed, and time slots are output to the Nx64k serial data interface.

Reversals of Tip and Ring wires are automatically detected and accommodated. The Monitor HDSL Span screen indicates if the Tip and Ring wires are reversed.

System Timing Circuits

The UTU and ETU units can synchronize to any one of the following timing sources:

- Nx64K: Serial-data port receive clock.
- INT: Internal oscillator.
- HDSL: Recovered clock from received HDSL data.
- EXT: External 2.048 MHz reference (available only for UTUs in a shelf with a management unit installed).

Timing for the signals transmitted over the HDSL link is nominally derived from the selected primary timing source. In case of failure of the primary timing source, the system utilizes the internal 2.048 MHz oscillator as the backup timing source.

The external reference clock option is available only for UTUs plugged into an Exchange Office Management Shelf (EMS-83x) with an Exchange Office Management Unit (EMU-830) installed in the same shelf.

The Transmit Clock option for the data port interface enables selection of the input clock source for the Transmit Data (SD) fed to the unit from the Data Terminal Equipment (DTE) device. The options are:

- INT RISING: Rising edge of the internal Send Timing (ST) clock.
- INT FALLING: Falling edge of the internal ST clock.
- EXT: External Terminal Timing (TT) clock from the DTE.

Figure 7 illustrates the Transmit Clock circuit function. When the data port has Nx64k selected as its primary timing source, the transmit clock is fixed to External.

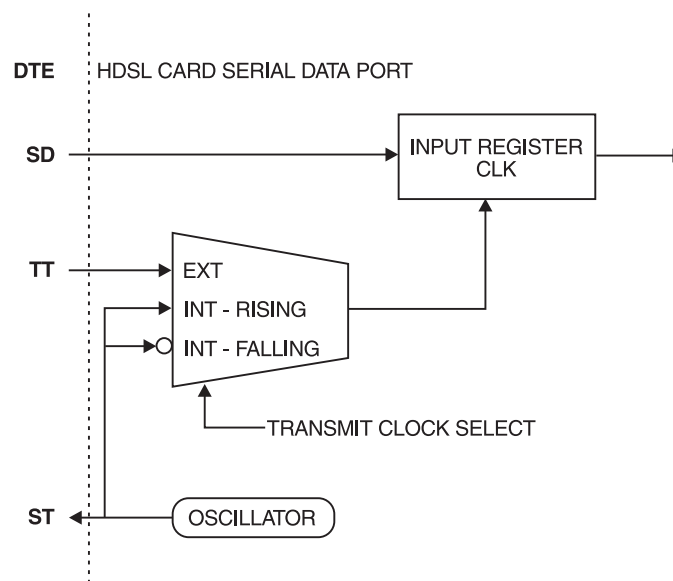

Figure 7. Data Port Transmit Timing

When the selected primary timing source is Internal, HDSL, or External, the transmit clock may be selected as Internal or External. The purpose of this selection is to compensate for a possible phase shift between SD and ST due to long interface cables or delay added by the DTE. Not all DTE equipment allows the DCE transmit clock (ST) to be sent back out as the transmit timing signal (TT), and the External transmit clock selection will not work with such equipment.

In general, it is best to always set the Transmit Clock option to External, as long as the DTE provides TT. Only if the DTE does not provide TT should one of the Internal options be used.

Processor

This device runs a program which in real-time:

- monitors the HDSL framer performance
- responds to user requests
- maintains a history of system performance.

On-Board Power Supply Modules

- The UTU-702C line unit has an on-board DC-to-DC power supply module.
- The ETU-752C desktop unit has an on-board AC-to-DC power supply module.
- A shelf-mounted UTU-702C receives power from a local source of -36 Vdc to -72 Vdc or from the EAC-830 In-Shelf Power Supply.
- An enclosure mounted UTU-702C receives power from a local source of -36 Vdc to -72 Vdc or from the enclosure's built-in AC-to-DC power supply (when provided).
- The ETU-752C receives power from its on-board AC-to-DC power supply.



The single pair rate selectable HDSL units (local and remote) must be locally powered.

SINGLE PAIR RATE SELECTABLE APPLICATIONS

Applications for single pair rate selectable HDSL are those that require transport of voice and data at various rates over various distances on a single pair of wire. Depending on line noise and the HDSL rate selected, spans of up to 8.5 km (5.3 miles) can be deployed without the use of doublers. The HDSL line rate depends on the number of time slots selected. The UTU-702C and ETU-752C each have 32 time slots with a bandwidth of from 64 kbps to 2048 kbps (1 to 32 time slots selected). Each time slot represents a 64 kbps increment of the available bandwidth.

The higher HDSL line rates can be used by private networks to transmit voice and data at high speeds over shorter spans. The full 2048 kbps bandwidth, for example, can be used with spans of up to 2.4 km.

Many applications do not require the full 2048 kbps bandwidth, but require an extended reach to the remote unit. For example, [Figure 8](#) shows a single-pair video-conferencing application using a 384 kbps HDSL payload rate (6 time slots selected). Customer data is input at the remote serial port and transported over the HDSL loop at 384 kbps to the exchange office, a distance of up to 4.7 km from the customer site.

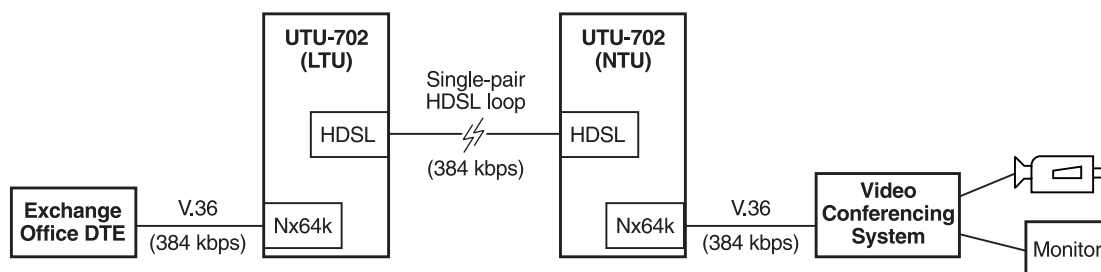

Figure 8. Single Pair Rate Selectable HDSL Video Conferencing Application

Single pair rate selectable HDSL units can also be used with Frame Relay networks. [Figure 9 on page 15](#) shows such an application where the remote unit is connected to a Frame Relay Access Device (FRAD) and the local unit is connected to a Frame Relay switch. The HDSL rate is set at 256 kbps (4 timeslots) for a reach of up to 5.1 km.

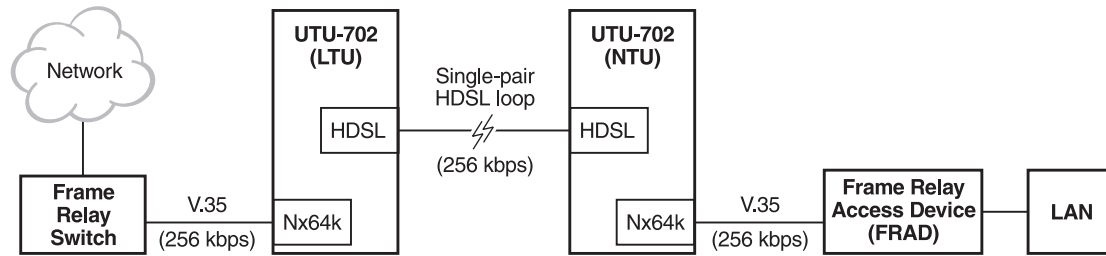

Figure 9. Single Pair Rate Selectable HDSL Frame Relay Application

Other applications for single pair rate selectable HDSL units include those where deployment of additional subscriber lines is limited by available two-pair HDSL spans. Using two single pair rate selectable HDSL units on each two-pair span can double the number of subscribers.

HOT SWAPPING

UTUs can be inserted and removed from any compatible shelf or enclosure with the power turned on. This will not cause damage to the units nor will it cause interference to any other HDSL circuits that are operating within the same shelf or enclosure.

PERFORMANCE MONITORING AND HISTORY

The UTU and ETU units provide extensive real time, non-disruptive monitoring of HDSL transmission performance parameters for all units in a circuit. Performance of the user interface ports is also monitored. Current cumulative counts of the past 24 hours and historical data in the form of 24-hour history (in 15-minute increments) and a 7-day history (in 24-hour increments) are available to assist in identifying problem sources during troubleshooting. See “View Status” on [page 43](#) for information on performance screens.

The monitored parameters are described in [Table 7](#).

Table 7. Monitored HDSL Transmission and Interface Performance Parameters

Monitored Parameter	Description
HDSL Noise Margin	A measure of the ratio of signal power to noise power, in decibels (dB), at a receiver point. A value of 0 dB means that the predicted transmission BER is equal to 10^{-7} , a value of 6 dB means the predicted transmission BER is equal to 10^{-10} . The Main menu status display continuously updates the margin value.
HDSL CRC-6	A six-bit word in every HDSL frame, representing a calculation based on all the bits in that frame. Any mismatch at the receiver, between the received CRC-6 and the one calculated, based on the received data in the frame, indicates that one or more bits were received in error. The units use this parameter to derive HDSL ES.
HDSL Loss of Sync Word (LOSW)	The unit has detected an error in one or more bits in six consecutive HDSL sync words. TS 101 135 requires two consecutive sync words to be received without error to clear this condition. A LOSW condition generally indicates the loop is down, thus data cannot be transmitted.
Based on the monitored parameters, the LTU and NTU units derive the following performance parameters:	
HDSL Errored Second (ES)	An interval of one second during which at least one CRC-6 error is detected at the incoming HDSL port or there is an LOSW condition.
HDSL Unavailable Second (UAS)	A second during which a loop is down.

ALARMS

The UTU and ETU units generate alarms for problem conditions on the HDSL transmission facility and at the local application interface. Alarms can be individually enabled or disabled as well as specified whether the alarm reports as a Major or Minor alarm. See “System Configuration” on [page 22](#) to configure alarms. See “View Status” on [page 43](#) to view alarm conditions.

The HDSL transmission and application interface alarms are described in [Table 8 on page 16](#).

Table 8. HDSL Transmission and Application Interface Alarms

Alarm	Description
HDSL Alarms	HDSL alarms (loop-specific) include:
Loss of Sync Word (LOSW)	The unit cannot receive data over the given HDSL loop.
Margin (MAR)	The HDSL noise margin of the loop has fallen below the set threshold.
Errored HDSL Second (ES) Threshold Exceeded	The number of HDSL ES has exceeded the threshold set to give advance warning that HDSL performance is deteriorating. This threshold can be set from 0 to 255 ES over a 24-hour period, or disable the alarm completely.
Nx64k Interface Alarm	The Nx64k Interface alarm is Loss of Clock (LOC). The DTE transmit clock (TT) was lost for the previous second. This alarm is reset when the clock is active again.
External Clock Alarm	The External Clock alarm is LOC. The external clock was lost for the previous second. Applies to loss of external clock when EXT timing is used. This alarm is reset when the clock is active again.
Alarm Indicators	The HDSL ALM and I/F ALM indicators on the front panel of the unit indicate local unit alarm conditions.
Alarm History	The units also compile an alarm history which can be viewed from a maintenance terminal, as described in “ LTU and NTU Interface Alarm History Screens ” on page 51 . For each alarm, the report provides: the date and time of the first alarm occurrence (since the alarm history was cleared), the last occurrence, the current status, and the number of times the alarm has occurred. This report is very useful when evaluating system performance.

LOOPBACKS

An HDSL system maintains several diagnostic loopback configurations, both toward and away from the local unit, which can be used to verify proper transmission of test data through the local unit, the HDSL facility, and the remote unit. [Figure 10 on page 17](#) shows all possible loopback paths. [Table 9 on page 17](#) lists available loopbacks.

During loopbacks the system generates an Alarm Indication Signal (AIS) past the loopback point toward the far unit. Loopbacks can be activated from the LOC (local) and REM (remote) front-panel pushbuttons, the Local Loopback (LL)/Remote Loopback (RL) signals on the Nx64K port, the console Test menus, and the management unit interface ([Table 10 on page 18](#) lists loopback equivalents for different activation methods). Only one loopback option can be enabled at a time. During a loopback, the Loopback LEDs on the front panel indicate the type of loopback currently present in the system. See [Table 4, “Line and Desktop Unit Front Panel LED Indications,” on page 6](#).

The system reverts to normal transmission of payload data after the specified timeout period has elapsed. If a timeout period is not specified, the loopback must be manually disengaged before normal transmission of data can resume.



Test loopbacks disrupt normal end-to-end transmission of customer data and are the equivalent of taking the circuit out of service. The circuit does not revert to normal operation until loopbacks are disengaged manually or until after the specified loopback timeout period has expired.

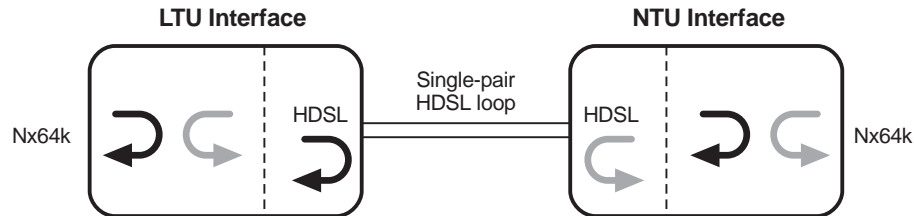

Figure 10. Loopback Operations

Table 9. Loopbacks Selected at Front Panel Pushbuttons and Console Screens

Loopback	Description
The two loopbacks that follow can be selected through the LOC and REM front-panel pushbuttons, the console screens, the Local Loopback (LL)/Remote Loopback (RL) control lines at the DTE, or the management unit interface.	
LOC Pushbutton—Local HDSL Loopback	This is an analog loopback implemented in both HDSL transceivers, and enables a complete checkout of the local equipment by looping back data at the furthest point before the transmission media. The HDSL link goes down as a result of this loopback, and is therefore not selectable from the remote unit console screens. The LL control line, when asserted from the local DTE, also engages this loopback.
REM Pushbutton—Remote Loopback	Data is transmitted across the HDSL link and looped back at the remote interface ports. The HDSL link must be up for this loopback to be available. With no HDSL link up, the REM button will not enable any loopbacks. The RL control line, when asserted from the local DTE, also engages this loopback.
The three loopbacks that follow are available exclusively from the console screens or management unit interface.	
Local Interface Loopback	Data is looped back at the closest point in the local unit toward customer equipment. This loopback is useful for verification of a proper connection at the local interface between your DTE and the local HDSL card. The HDSL link is maintained during this loopback.
Local or Interface Loopback Away from the Local Equipment	Data is looped back at the local unit or remote unit back toward the remote DTE equipment. This is equivalent to pressing the REM button on the remote unit's front panel, and is made available at the local console screen for ease of installation. The injected test data and loopback verification must still be performed at the remote unit site. Local equipment outputs an AIS for the duration of this test.
Remote Interface Away from the Local Equipment	Data is looped back at the remote unit toward the remote DTE equipment. This is available at the local console screen for the duration of this test. The injected test data and loopback verification must still be performed at the remote unit site. Local equipment outputs an AIS for the duration of this test.

The following applies to LTU and NTU loopbacks:

- No inband loopback codes are recognized or generated.
- A remote HDSL loopback is not available from the local console screen as it causes the HDSL link to go down and requires user action at the remote unit to disengage the loopback.
- The DTE should supply timing for local Nx64k interface loopbacks (internal timing supplied by the local HDSL unit may not function correctly).

Table 10 summarizes the equivalent loopbacks for two different activation methods:

- LTU and NTU LOC and REM buttons
- Console screen Test menus (see “Testing” on page 57 for loopback operation from the Test menus).

Table 10. Loopback Equivalents

Front Panel	Console Screen Test Menu		Data Port Control Signals	
	Loopback mode	Loopback Position	LTU Nx64k port	NTU Nx64k port
LTU LOC button	NETWORK ^(a)	LTU-HDSL	LL	
LTU REM button	NETWORK	NTU-I/F	RL	
	NETWORK	LTU-I/F		
NTU LOC button	CUSTOMER ^(b)	NTU-HDSL		LL
NTU REM button	CUSTOMER	LTU-I/F		RL
	CUSTOMER	NTU-I/F		

(a) Activated from console screen Test menu at LTU.

(b) Activated from console screen Test menu at NTU.

BER TESTING

The HDSL units provide a mechanism for validating circuit integrity utilizing a pseudorandom bit sequence (PRBS) generator and BER meter internal to the LTU unit. This diagnostic test disrupts the normal flow of payload traffic, and requires the presence of a Network NTU-I/F loopback or an external physical loopback at the NTU interface connector. The test is run at the selected HDSL Payload Rate (see Table 15 on page 35). BER results are accumulated continuously and updated on the console screen at intervals of approximately 16 seconds.

The PRBS data pattern is always generated at the LTU toward the HDSL channel, and the BER is always measured at the LTU based on data received from the HDSL channel. The test may be initiated and stopped from the Test menu at either the LTU or NTU console screen.



The BER test must be stopped before leaving the test menu in order to restore normal payload transmission. Escaping while the BER test is in progress causes the following message to display: “BER Test in Progress. Must STOP before leaving screen.”

INSPECTION, SAFETY, AND EQUIPMENT REPAIR

This section describes the procedures to be followed regarding product inspection, safety, and repair.

INSPECTION

Open the line or desktop unit shipping carton and inspect the contents for signs of damage. If the equipment was damaged in transit, immediately report the extent of the damage to the transportation company and to ADC Technologies (see “Product Support” on page 66).

SAFETY

To ensure safety of personnel and equipment, carefully observe the following safety rules:



Be careful when installing or modifying telephone lines. Dangerous voltages can be present. It is unsafe to install telephone wiring during a lightning storm.

Always disconnect all telephone lines and power connections before servicing or disassembling this equipment. For performance and safety reasons, only power supplies listed for use with telephone equipment by a locally recognized organization should be used with ADC equipment. All wiring external to the product should follow the local wiring codes.

Bitte beachten Sie, dass beim Installieren oder Veraendern von Telefonleitungen gefaehrliche Spannungen entstehen koennen. Es ist ebenfalls gefaehrlich, waehrend eines Gewitters Installationen an Telefondraehten vorzunehmen.

Bei Installation, Wartung oder Veraenderung des Geraetes muessen alle Telefon- und Netzkabel ausgezogen werden. Aus Sicherheitsgruenden und um eine optimale Geraeteleistung der ADC Produkte zu erzielen, verwenden Sie bitte nur Netzteile, welche auf die betreffenden Telefongeräte zugeschnitten sind und im Fachhandel vertrieben werden. Alle externen Verdrahtungsarbeiten sollten gemaess den Elektrizitaetsvorschriften des jeweiligen Landes ausgefuehrt werden.

EQUIPMENT REPAIR

To ensure the equipment does not become damaged, carefully observe the following cautions:



If a problem has been isolated to this unit, do not attempt to repair it. The unit's components are not user serviceable and, therefore, must not be replaced. Please return the unit to ADC for repairs.

Wenn eine Störung auf dieses Gerät zurückgeführt werden kann, sollte man nicht versuchen es zu reparieren. Die Geräteteile sind nicht vom Endverbraucher zu warten und müssen darum nicht ersetzt werden. Bitte senden Sie das Gerät zur Reparatur zurueck an ADC.

INSTALLATION AND STARTUP

This section describes the installation and startup procedures for the line and desktop units.

UTU-702C LINE UNIT INSTALLATION

Perform the following steps to install the UTU-702C line unit.



The chassis ground of the shelf or remote enclosure receiving these units must be connected to earth ground for protection of the equipment and for safety of personnel.

Other protection is required when the network side of the equipment is extended to an outside facility.

- 1 Align the UTU-702C with the card guides in the shelf or enclosure (see [Figure 11](#)).
- 2 Slide the line unit into the guides, then push the unit inward until it seats firmly in the card-edge connector.
- 3 Tighten the two captive screws on the UTU-702C front panel to secure the unit in place.
- 4 If configuring the line unit as an LTU, power up the shelf and proceed as instructed on pages [22](#) through [24](#) and [34](#) to access the Local Unit Role option in the *Config System Settings* menu (the default setting is NTU).
- 5 Set the TT clock at the DTE for the default HDSL payload rate of 256 kbps (4 time slots).

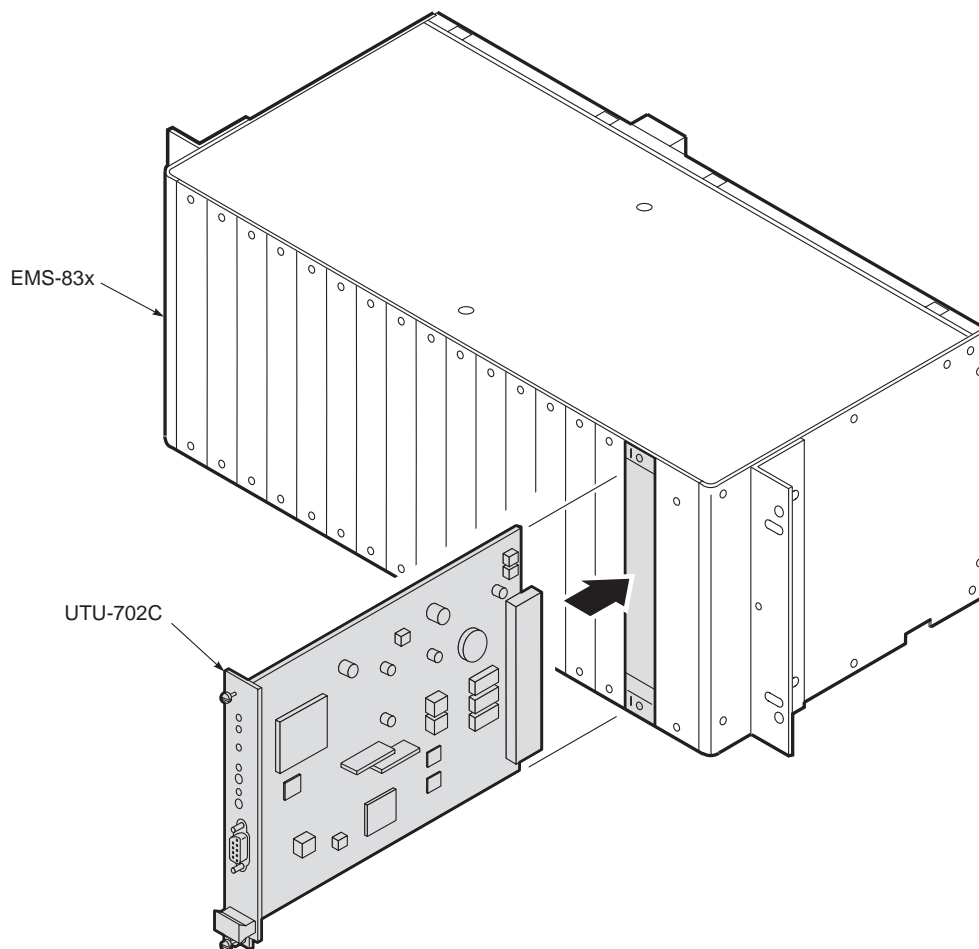

Figure 11. Installing the UTU-702C Line Unit



The line and desktop units will reset and their LEDs will sequence through the startup cycle following any change to the Local Unit Role option. If necessary, log on again by pressing the **SPACEBAR** several times.

ETU-752C DESKTOP UNIT INSTALLATION

Perform the following steps to install the ETU-752C desktop unit.

- 1 Insert the AC power cord into the power cord receptacle on the ETU rear panel.
- 2 Plug the power cord into a source of 100 to 240 volt, 50 or 60 Hz AC power.
- 3 If configuring the desktop unit as an LTU, power up the shelf and proceed as instructed on pages 22 through 24 and 34 to access the Local Unit Role option in the *Config System Settings* menu (the default setting is NTU).
- 4 Connect the data port cable from the DTE to the data port connector on the ETU-752C rear panel.
- 5 Connect the HDSL line cable to the HDSL line connector on the ETU rear panel.
- 6 Set the TT clock at the DTE for the default HDSL payload rate of 256 kbps (4 time slots).

HDSL STARTUP AND SYNCHRONIZATION

The rate selectable LTU holds the configuration settings for the rate selectable NTU. At startup, the LTU first confirms that the NTU is a rate selectable unit. The LTU then configures the NTU with the required settings.

Power up the rate selectable units and observe the synchronization process as follows:

- 1 Power up the shelf or enclosure where the unit(s) are installed.
- 2 Confirm the following:
 - The HDSL ALM LED is on and the HDSL SYNC LED flashes once per second as the units self-configure and establish synchronization.
 - After approximately 60 seconds the HDSL ALM LED is off and the HDSL SYNC LED is a steady green. The units are now ready for configuration through the console screen menus.



If the HDSL SYNC LED continues to flash after 90 seconds, the HDSL line is faulty or one of the units is not a rate selectable unit. Check for the correct line units. Test the HDSL line using the loopbacks described in “Testing” on page 57. Front panel loopback (LPBK) LED indications are described in Table 4 on page 6.

The LTU and NTU will reset and the LEDs will cycle following any change to the HDSL Payload Rate option (see “Configure System Settings” on page 34).

SYSTEM CONFIGURATION

Each line unit provides a system-wide view of the entire HDSL circuit, including the remote unit. After establishing communication with the remote line card, provisioning information can be set and performance can be monitored from the local unit. If the HDSL link is down, the only parameters that can be changed are those on the local line unit. The LTU will overwrite any NTU settings when the link is re-established. The LTU also provides a special lockout feature that prevents users plugged into the NTU console port from changing the circuit configuration. When this feature is enabled, the maintenance terminal connected to an NTU displays a read-only view of the entire HDSL system.



The console screen menus are not available when the HDSL card is under the control of a shelf management unit.

The line unit option settings are stored in non-volatile RAM (NVRAM). No dip switches or jumpers are required to configure these options. These options are set from the console screen menus or management unit interface. Option settings stored in NVRAM are retained if the line unit loses shelf power.

MAINTENANCE TERMINAL CONNECTION

The maintenance terminal (or PC running a terminal emulation program) is used to access the console screen menus. Through these menus, the system is configured, monitored, tested, and its circuit inventory is displayed.

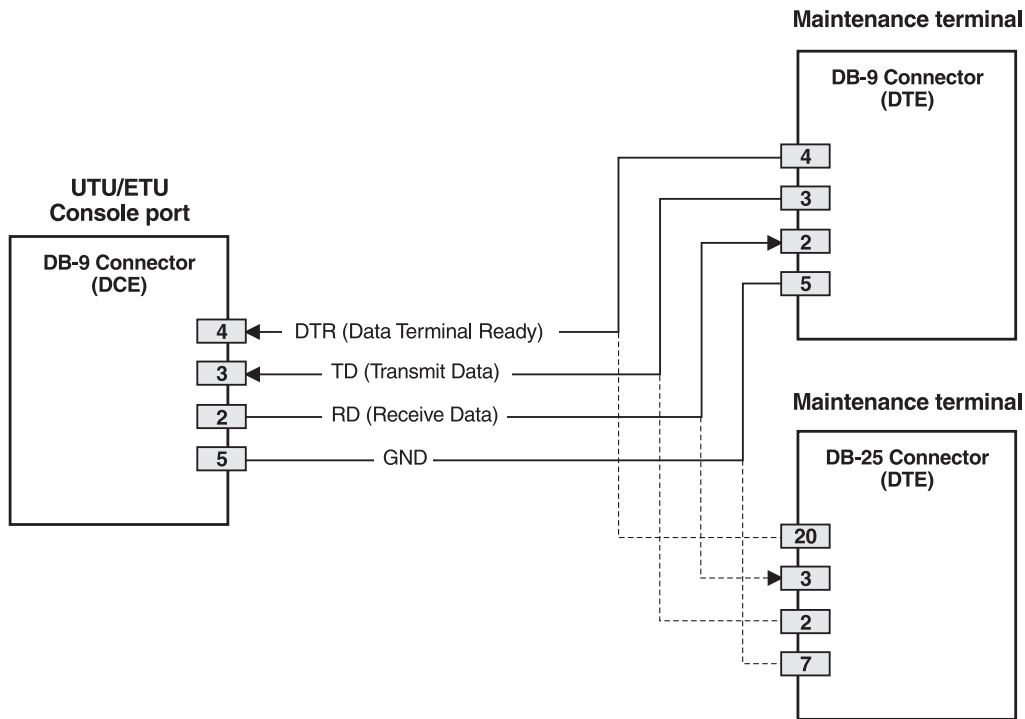

Figure 12. UTU/ETU Console Port and Maintenance Terminal Connector Pinouts

To connect and configure a maintenance terminal:

- 1 Connect a serial cable from the maintenance terminal 9-pin COM port to the line or desktop unit console port connector (Figure 13). Ensure the Data Terminal Ready (DTR) signal from the terminal is connected as the HDSL card will not communicate without it. Data Terminal Ready (DTR) may also be asserted by connecting the DSR output signal (pin 6) to the DTR input (pin 4).

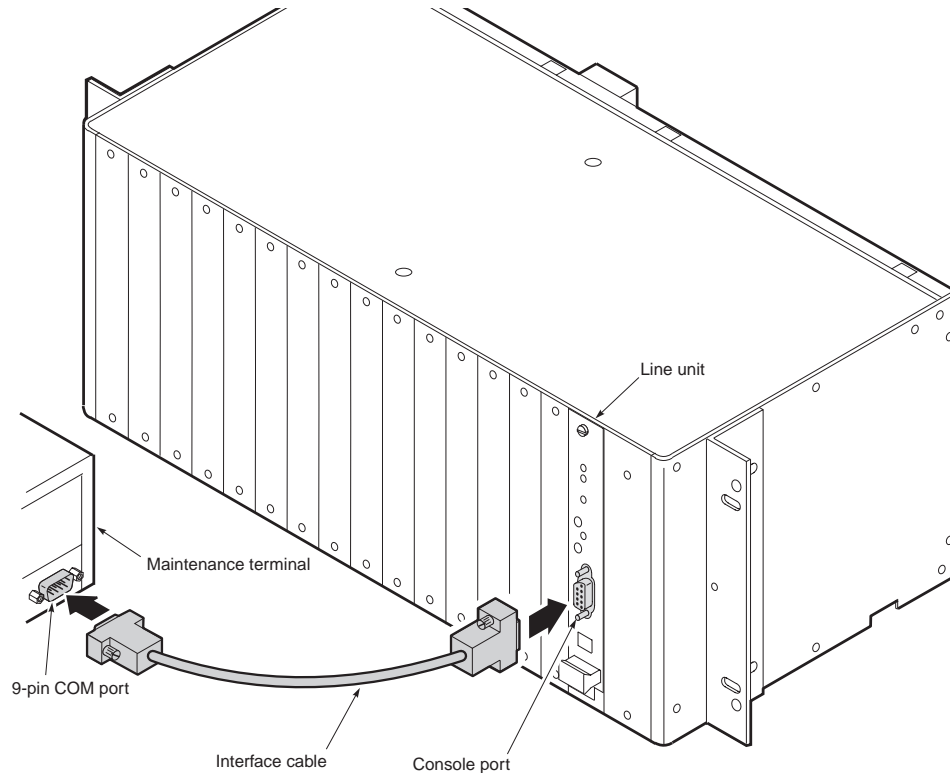

Figure 13. Connecting a Maintenance Terminal to a Line Unit

- 2 Configure the maintenance terminal for the following communication settings:
 - VT100 Emulation or ANSI (if VT100 is not available)
 - clear the modem initialization string if supported by the terminal
 - Bits per second: 1200, 2400, 4800, 9600 (default), or 19200 bps (recommended)
 - Data bits: 8
 - Parity: None
 - Stop bits: 1
 - Flow Control: None

If using a PC and Microsoft Windows terminal emulation program, deselect “Show Scroll Bars and Use Function, Arrow, and Ctrl Keys” from the Settings Terminal Preferences menu for Windows 3.1 or from the Properties menu for Windows 95.

MODEM CONNECTION

For remote access to the line units, an auto-answer modem can be connected to the console port. Use a null modem cable to connect the HiGain-ETSI line unit and the modem.

LOGGING ON

To log on to the maintenance terminal console screen:

- 1 Press the **SPACEBAR** several times to display the Logon Password screen (Figure 14).

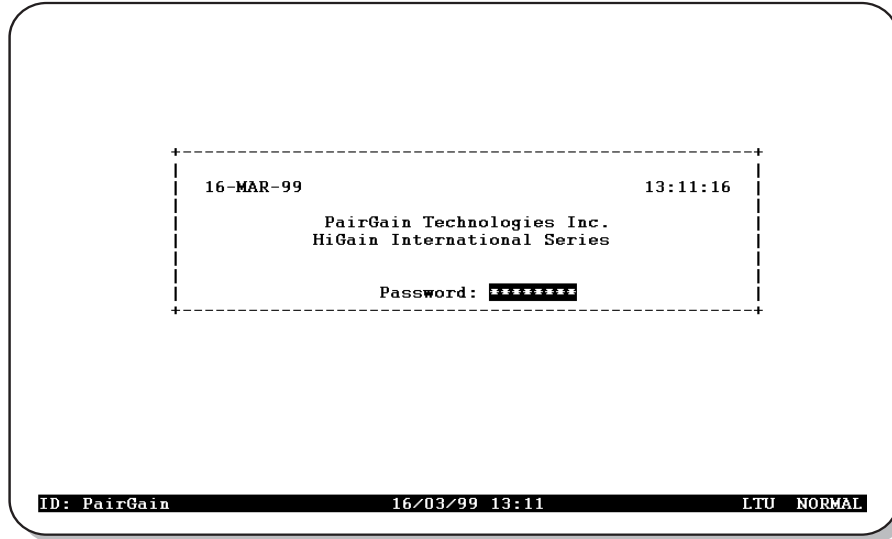

Figure 14. Logon Password Screen



The **ENTER** key is the factory default password. If you establish a different password, you must type the new password (single word, no spaces, up to eight characters) on a subsequent log on. If the system does not respond, verify that the Hardware Flow Control of the maintenance terminal is set to NONE.

- 2 Type the password at the prompt or press **ENTER** if a password has not been customized. The console screen menu bar displays (Figure 15).



Figure 15. Console Screen Menu Bar

CONSOLE SCREEN MENU STRUCTURE

The following sections describe the structure of the console screen and how to read and navigate through its displays and menus.

The structure of the console screen displays and drop-down menus is shown in Figure 16. The names in the console screen menu bar identify each display and menu. The arrows in the menu bar following the Monitor, History, and Config names indicate the presence of a drop-down menu or sub-menu. The designations Display and Displays indicate that a display is associated with the name in the menu bar or its drop-down menu.

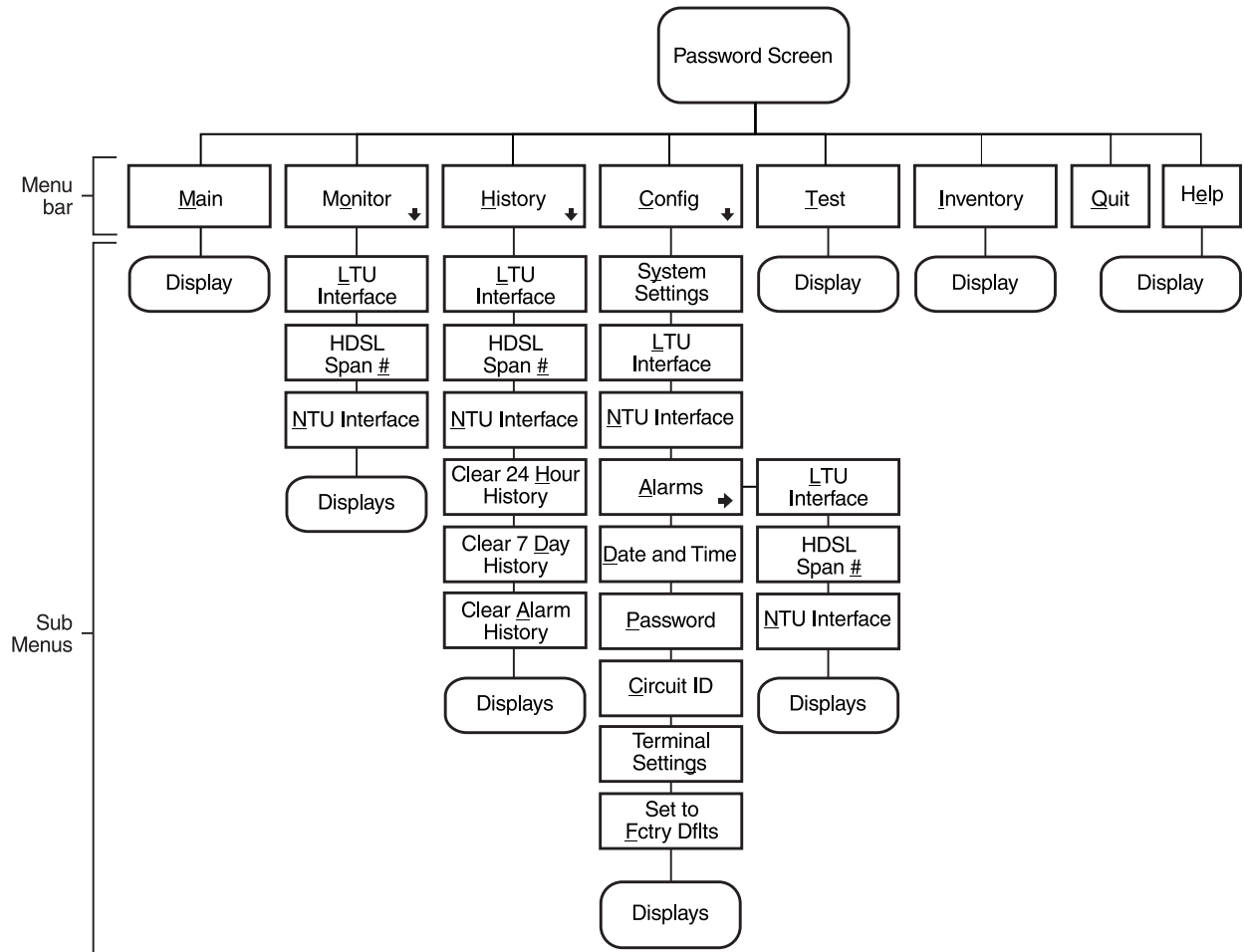

Figure 16. Console Screen Menu Structure

Table 11 describes the drop-down menus selected from the console screen.

Table 11. Console Screen Menus

Menu Name	Function	Described in this section
Main	Display the Main console screen to: <ul style="list-style-type: none"> • View the circuit configuration • View performance summary information • View alarm summary information. 	“Main Console Screen” on page 43
Monitor	Monitor the past 24-hour performance of the LTU interfaces, NTU interfaces, or HDSL spans.	“Monitor Menu” on page 45
History	View 24-hour, 7-day, or alarm history displays for any of the following: <ul style="list-style-type: none"> • LTU interface • HDSL spans • NTU interface • Clear all the 24-hour, 7-day or alarm histories 	“History Menu” on page 49
Config	Perform any of the following system functions: <ul style="list-style-type: none"> • View or change global operating parameters for the system • View or change LTU interface, HDSL span, or NTU interface operating parameters • View or change alarm parameters • Set the time and date • Set or change the unit password • Change the circuit ID • Configure terminal display • Set all operating parameters to factory defaults 	“Config Menu Options” on page 29
Test	Perform any of the following test functions: <ul style="list-style-type: none"> • Set the loopback mode and location • Set the loopback time-out • Enable or disable loopback operation • Initiate BER test and monitor BER results 	“Testing” on page 57
Inventory	Display registration information to track product manufacturing, configuration, and revision state.	“Inventory Screen” on page 55
Quit	Log off the system.	“Logging Off” on page 42
Help	Display a screen of helpful information regarding the product.	-

READING AND NAVIGATING MENUS

The menu and status bars appear on all console screens. The information on the rest of the screen varies depending on the function of the menu or screen.

The menu bar displays the name of each menu. Choosing *Monitor*, *History*, or *Config* from the menu bar drops down a menu of available options. When selected, all options on the *Monitor* drop-down menu, and the *Alarm* option on the *Config* drop-down menu, display drop-down submenus.

The status bar at the bottom of the screen displays the circuit ID, the current date and time, unit type, and current system information. Select *Config* from the console screen menu bar to enter or change the circuit ID and the current date and time. The items described in [Table 12](#) correspond to the numbers in [Figure 17](#).

Table 12. Console Screen Status Bar Displays

Item	Field	Description
1	Circuit ID	Shows the user-selected name for the circuit (such as customer name).
2	Date and time	Today's date in dd/mm/yy format. Today's time in 24-hour format.
3	Local unit role	Either LTU or NTU.
4	System information	Displays the current system status. The system information field shows one of the following: <ul style="list-style-type: none"> • Loop down - At least one configured HDSL channel is down, either due to restart, or startup not completing. • Alarm - A major alarm condition is currently active in the system. In the case of a loopback bringing the loop down, LOSW alarms will be ignored. • Loopback - The system is in a diagnostic loopback configuration. • Update - Circuit-wide provisioning is in progress. • Normal - All configured HDSL channels are up in the circuit, no alarms are present, and provisioning is complete.

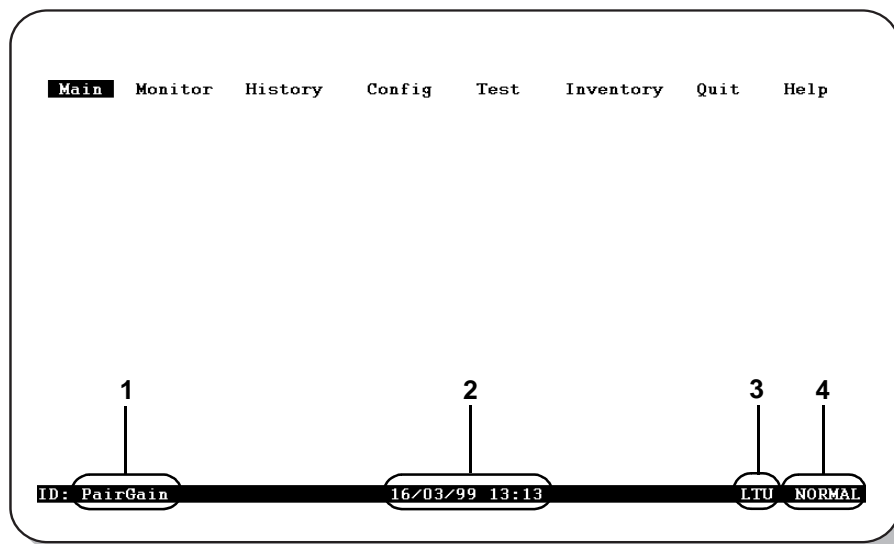

Figure 17. Items in Console Screen Status Bar

Use the keys described in [Table 13](#) to navigate the console screen and its menus:

Table 13. *Console Screen Navigation Keys*

Press this Key	To Perform this Function
Alpha-numeric keys	Type the underlined or highlighted letter to select and execute a menu item. For example on the Main console menu, type C to access the <i>C</i> onfig drop-down menu. Also use these key to enter values in text fields. For example, on the <i>Config Date and Time</i> menu, type the date in a DD/MM/YY format.
← and → keys	Moves horizontally across the Menu bar, except when in a text entry field.
↑ and ↓ keys	Press the ↑ and ↓ keys from the Main console screen to access drop-down menus and their menu items. For example: <ul style="list-style-type: none"> press the ← and → keys to select <i>Config</i> in the menu bar and press the ↓ key to access the drop-down configuration menu, then press the ↑ and ↓ keys to highlight a menu item and press ENTER to select the item.
TAB key	Provides same function as the ↓ key.
CTRL + E	CTRL + E moves up one line in the History screens.
CTRL + X	CTRL + X moves down one line in the History screens.
CTRL + C	CTRL + C performs the page-down function in the History screens.
CTRL + R	CTRL + R performs the page-up function in the History screens.
SPACEBAR	Selects options displayed for current menu item. For example, to select MANUAL or Nx64k AUTO mode from the <i>Config System Settings</i> menu: <ul style="list-style-type: none"> press the ↓ key to highlight the HDSL Rate Mode option, then press the SPACEBAR until the desired option (MANUAL or Nx64k AUTO) is highlighted.
ESC	Exits the current screen and returns to the previous screen. Selection changes made on the current screen are discarded. Pressing ESC in a text field cancels the text entry and restores the old value.
ENTER	Applies all selections on the current screen. For example, to select an HDSL payload rate from the <i>Config System Settings</i> menu: <ul style="list-style-type: none"> press the ↓ key to highlight the HDSL Payload Rate option, then type the desired number of time slots (1 to 32) and press ENTER to display the selected HDSL payload rate (in MANUAL mode only).

Config Menu Options

Type **C** at the console screen (Figure 17) to display the *Config* menu (Figure 18). Table 14 lists the *Config* menu options and the order of system configuration.

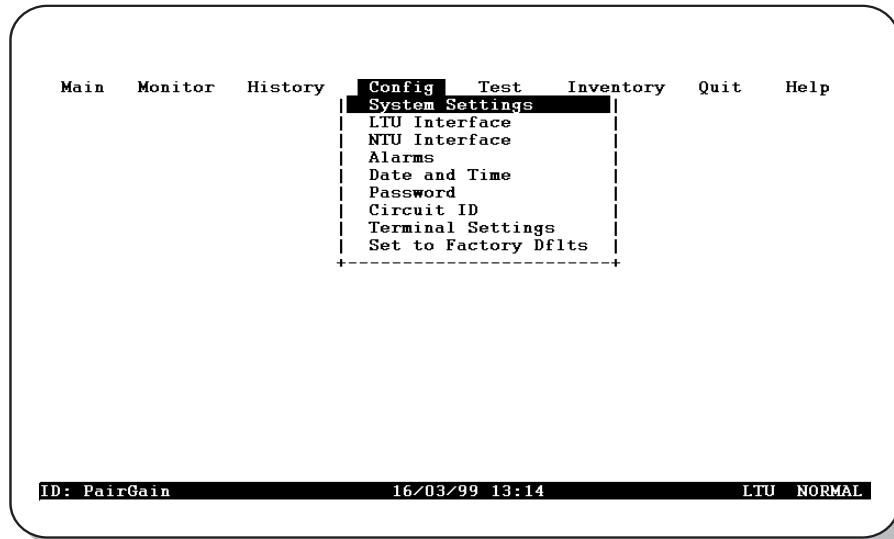

Figure 18. Console Screen Config Menu

Table 14. Config Menu Options and Recommended Order of System Configuration

Use this Option	To:	See page:
Terminal Settings	Select the best viewing mode for the console screen.	30
Date and Time	Set the system date and time.	31
Password	Set or change the system password.	32
Circuit ID	Assign a circuit ID.	33
System Settings	Select and configure system-wide operating parameters.	34
LTU and NTU Interface	Select and configure LTU/NTU-specific operating parameters.	36
Alarms	Enable or disable alarms and to select alarm severity.	39 and 40
Set to Factory Dflts	Reset all operating parameters to factory settings.	41

Observe the following when configuring a system:

- Configure settings in the order specified in Table 14. The *System Settings* must be configured before the *LTU and NTU Interface* settings. Changing *System Settings* can clear values configured in *LTU and NTU Interface* settings.
- When using a UTU as an LTU, change the Local Unit Role for the unit using the *Config System Settings* menu. Note that changing the Local Unit Role of a UTU causes the unit to reset and the LEDs to cycle.
- When the HDSL units are reset or cycle power, the date field is saved but the time field is not saved. Set the time using the *Config Date and Time* display. When the HDSL units are turned off and left off for a longer period of time (more than 24 hours, for example), set both the date and time using the *Config Date and Time* display since neither value was saved.

Configure Terminal Settings



The console screens use line drawing characters to enclose menu selections and dialog boxes. Because not all maintenance terminals and terminal emulation programs adhere consistently to the VT100 standard, the HDSL card allows you to adjust the display for best results on a given terminal.

- 1 Type **T** at the *Config* drop-down menu to display the *Config Terminal Settings* menu (Figure 19).

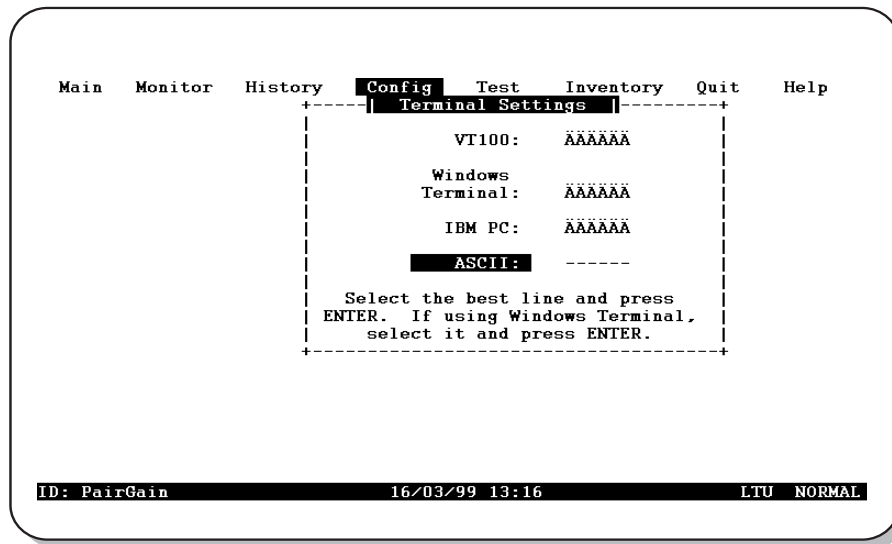

Figure 19. Config Terminal Settings Menu

- 2 Press the **↑** or **↓** key to highlight the selection that matches the terminal configuration (which should also be the selection most clearly displayed on the monitor). The choices are:
 - VT100
 - IBM PC
 - ASCII
 - WINDOWS TERMINAL
- 3 Press **ENTER** to confirm the selection.

Configure Date and Time

- 1 Type **D** at the *Config* drop-down menu to display the *Config Date and Time* menu (Figure 20).

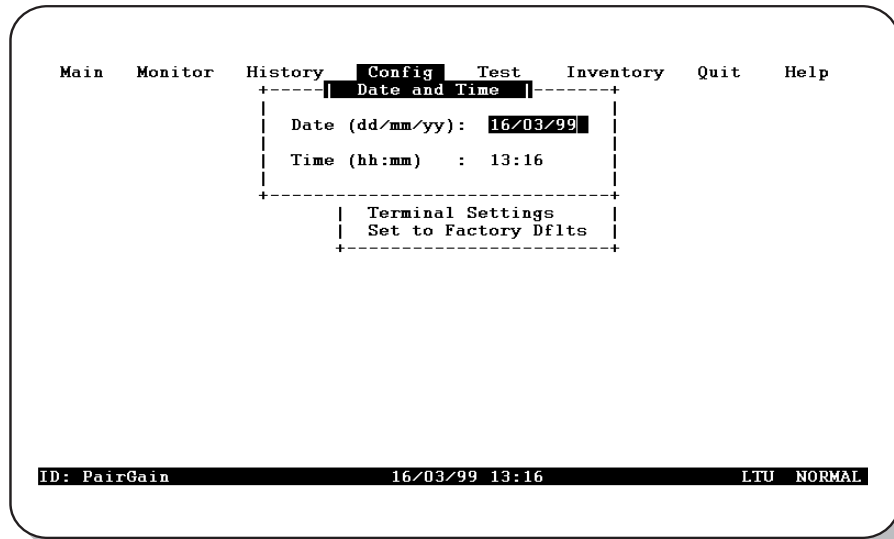

Figure 20. Config Date and Time Menu

- 2 Type the date in DD/MM/YY format, then press **ENTER**.
- 3 Type the time in HH : MM format (24-hour clock), then press **ENTER**.

The system date and time appear on the status line of the console screen and is useful when viewing alarm histories. When the HDSL units are reset or cycle power, the values in the date field are saved but the values in the time field are reset to 00:00. Set the time using the *Config Date and Time* display. When the HDSL units are turned off and left off for more than 24 hours, both the date and time must be set using the *Config Date and Time* display (neither value is saved after 24 hours).



Changing the date and time after the system has been running will not automatically clear alarm histories. This must be done after setting the date and time. (See “Clear History Screens” on page 55.)

Change Password

- 1 Type **P** at the *Config* drop-down menu to display the *Config Change Password* menu (Figure 21).

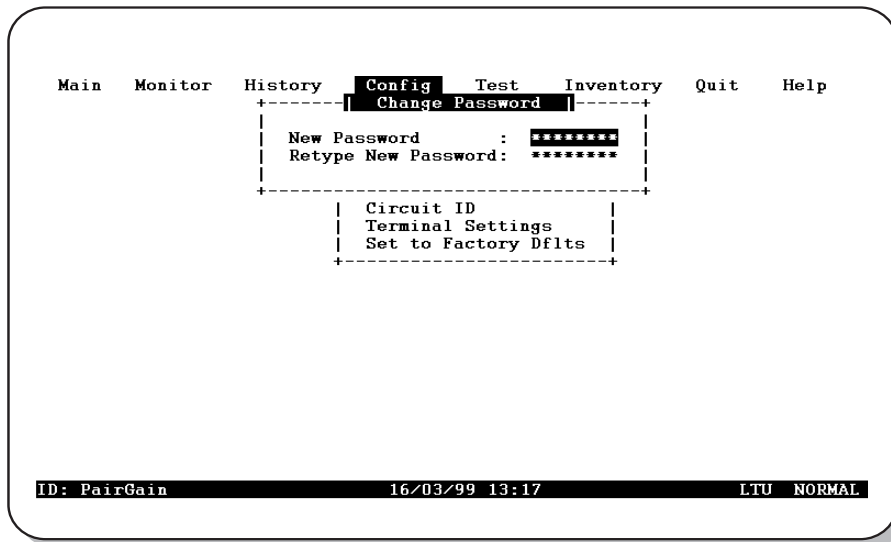

Figure 21. Config Change Password Menu

- 2 Enter a new password (up to eight characters) to change the current system password.
- 3 Retype the new password (up to eight characters) to confirm its accuracy.



When changing the default password (**ENTER**), save the new password in a secure place. A password cannot be recovered if it is forgotten. Contact a ADC Regional Sales Office if assistance is needed (see [page 66](#)).

Configure Circuit ID

The circuit ID appears on the status line of each console screen. Choose a unique circuit ID for each HDSL card.

- 1 Type **C** at the *Config* drop-down menu to display the *Config Circuit ID* menu (Figure 22).

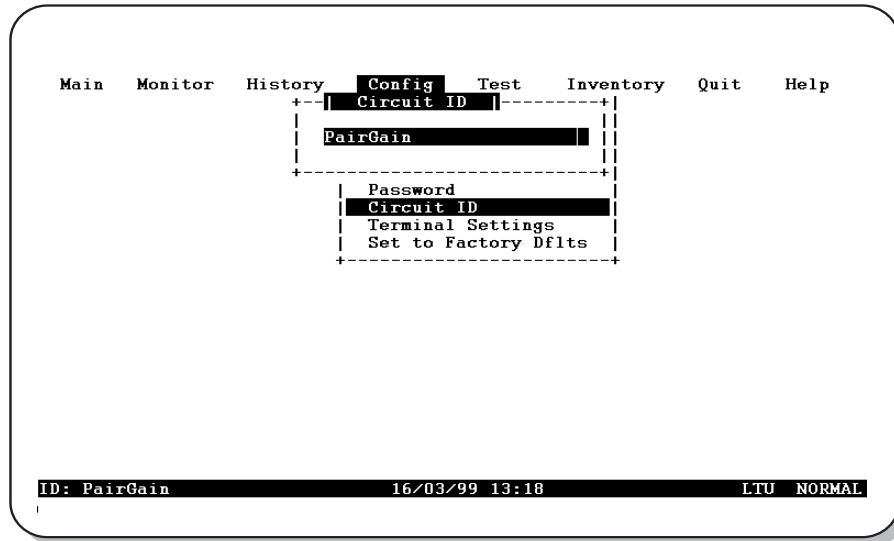

Figure 22. Config Circuit ID Menu

- 2 Type a new circuit ID (up to 23 characters) to change the current circuit ID.

Configure System Settings

Use the *System Settings* menu to select and configure system-wide operating parameters. Configure system settings as follows:

- 1 Type **S** at the *Config* drop-down menu to display the *Config System Settings* menu. [Figure 23](#) shows the *Config System Settings* menu for the UTU-702C and ETU-752C.

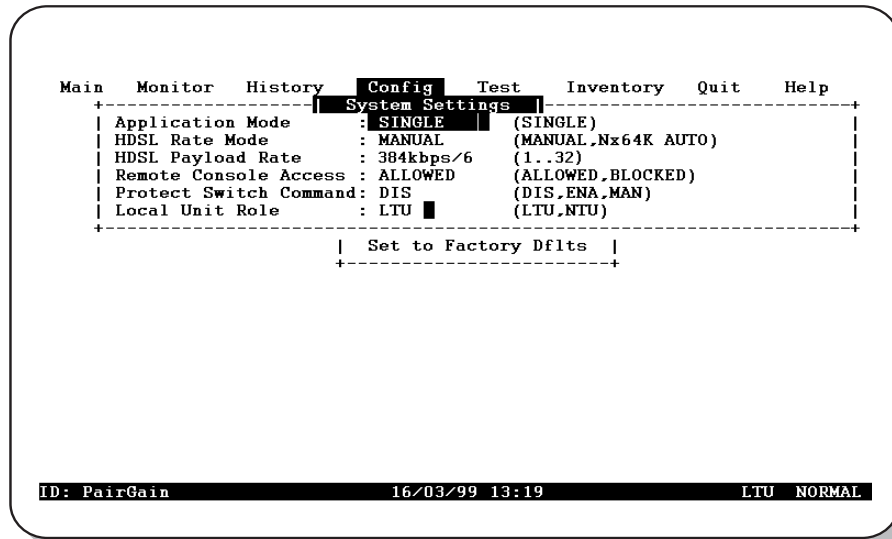

Figure 23. *Config System Settings Menu*

- 2 Do the following for each system option setting to be changed. [Table 15 on page 35](#) describes the fields and options displayed in the *Config System Settings* menu. The settings in boldface type are factory default settings.
 - Use the **↑** or the **↓** key to select the sub-menu item to be changed.
 - Use the **SPACEBAR** to toggle to the appropriate option or type in the correct information, then press **ENTER** to select the option.



When using a UTU or ETU as an LTU, configure the Local Unit Role option first.

Table 15. *Fields and Options in Config System Settings Menu*

Field and Options	Description
Application Mode ^(a)	
SINGLE	System uses a single-pair of twisted copper wire to transport data. For more information, see “Single Pair Rate Selectable Applications” on page 14.
HDSL Rate Mode	
MANUAL	HDSL payload rate is set by number of time slots entered for the HDSL Payload Rate option. ^(b) Each time slot is 64 kbps.
Nx64K AUTO	HDSL payload rate is determined by TT clock input at Nx64k data port. Choosing this option automatically sets Primary Timing Source to Nx64k (see Table 16 on page 37).
HDSL Payload Rate ^(c)	
256kbps/4	Typing a time slot value of 1 through 32 and pressing ENTER sets and displays the HDSL payload rate (in MANUAL mode only). Payload rate is automatically set in Nx64K AUTO mode. ^(d) ^(e)
Remote Console Access	
ALLOWED	NTU console screens can be used to configure the system.
BLOCKED	NTU console screens are read-only. The LOC and REM pushbuttons on the NTU are also disabled. System changes can only be made from the LTU.
Protect Switch Mode	
Not available on Nx64k serial data port units.	
Local Unit Role	
Configures UTU or ETU as LTU (master) or NTU (slave). The default configuration is NTU (slave). Note that changing the Local Unit Role of a UTU or ETU causes the unit to reset and the LEDs to cycle.	
LTU	Configures UTU or ETU as LTU (master). The LTU-configured rate selectable UTU/ETU does not provide line power to other HDSL units.
NTU	Configures UTU or ETU as NTU (slave). The NTU-configured rate selectable UTU/ETU does not provide line power to other HDSL units.
<p>(a) SINGLE is the only application mode.</p> <p>(b) UTU-702C and ETU-752C have 32 time slots available for rates of 64 kbps to 2048 kbps.</p> <p>(c) An HDSL Payload Rate of 64 kbps (1 time slot) is transmitted at 128 kbps.</p> <p>(d) Payload rates in both the MANUAL and Nx64K AUTO modes are displayed in the Config LTU and Config NTU Interface menus as Data Rate/# of TSs (data rate/number of time slots).</p> <p>(e) Changing the HDSL Payload Rate or Local Unit Role causes the unit to reset and the LEDs to cycle. Log on again by pressing the SPACEBAR several times.</p>	

Configure LTU and NTU Interfaces

Select and configure the LTU- and NTU-related operating parameters as follows:

- 1 Type one of the following at the *Config* drop-down menu to display the *Config LTU or NTU Interface* menu:
 - **L** for the *Config LTU Interface* menu (Figure 24).
 - **N** for the *Config NTU Interface* menu (Figure 25).

```

Main  Monitor  History  Config  Test  Inventory  Quit  Help
-----|-----|-----|-----|-----|-----|-----|-----
          |  LTU Interface  |
-----|-----|-----|-----|-----|-----|-----|-----
Primary Timing Source: INT          (INT,EXT,Nx64K,HDSL)

Nx64K Port
Interface Type      : V.35          (V.36,X.21,RS530,V.35)
Data Rate/# of TSs : 384kbps/6      (32)
Beginning TS        : 0              (0)
Transmit Clock      : INT_RISING    (INT_RISING,EXT,INT_FALLING)
CTS                 : STD            (STD,ON,OFF)
DSR                 : STD            (STD,ON,OFF)
RLSD                : STD            (STD,ON,OFF)
LL/RL               : ENA           (DIS,ENA)
-----|-----|-----|-----|-----|-----|-----|-----
ID: PairGain      16/03/99 13:21      LTU  NORMAL

```

Figure 24. Config LTU Interface Menu

```

Main  Monitor  History  Config  Test  Inventory  Quit  Help
-----|-----|-----|-----|-----|-----|-----|-----
          |  NTU Interface  |
-----|-----|-----|-----|-----|-----|-----|-----
Primary Timing Source: HDSL         (INT,EXT,Nx64K,HDSL)

Nx64K Port
Interface Type      : V.35          (V.36,X.21,RS530,V.35)
Data Rate/# of TSs : 384kbps/6      (32)
Beginning TS        : 0              (0)
Transmit Clock      : EXT            (INT_RISING,EXT,INT_FALLING)
CTS                 : STD            (STD,ON,OFF)
DSR                 : STD            (STD,ON,OFF)
RLSD                : STD            (STD,ON,OFF)
LL/RL               : ENA           (DIS,ENA)
-----|-----|-----|-----|-----|-----|-----|-----
ID: PairGain      16/03/99 13:21      LTU  NORMAL

```

Figure 25. Config NTU Interface Menu



The Data Rate/# of TSs and Beginning TS parameters in the Config LTU and NTU Interface menus are read-only displays. The Data Rate/# of TSs value is set in the Config System Settings menu as the “HDSL Payload Rate” (see Figure 23 on page 34). The Beginning TS value is fixed at 0.

- 2 Do the following for each interface option to be changed. [Table 16](#) describes the fields and options displayed in the *Config LTU* and *Config NTU Interface* menus.
- Use the **↑** or the **↓** key to select the sub-menu item to be changed.
 - Use the **SPACEBAR** to toggle to the appropriate option or type in the correct information, then press **ENTER** to select the option.



The settings in boldface type in [Table 16](#) are factory default settings.

Table 16. *Fields and Options in Config LTU and Config NTU Interface Menus*

Field and Options	Description
Primary Timing Source ^(a)	Selects the source of clock for the HDSL transmit direction. The choices are: <ul style="list-style-type: none"> INT - Internal Oscillator EXT - External 2.048 MHz clock (UTU-702C only) Nx64k - Nx64k Serial Data port receive clock (TT) HDSL - Recovered clock from received HDSL data
Nx64k Port	
Interface Type	Select the interface standard for serial data port. The options are: V.35, V.36 , X.21, and RS-530. See Table 17 for details about the interface types.
Data Rate/# of TSs	Read-only display of HDSL data rate and corresponding number of time slots (TSs) as set automatically by TT clock (Nx64K AUTO mode) or by HDSL Payload Rate option in <i>Config System Settings</i> menu (MANUAL mode). See Figure 23 on page 34 . Default is 256kbps/4 .
Beginning TS	Read-only display of beginning time slot. For these units Beginning TS is always 0 (zero).
Transmit Clock	Selects the transmit data (SD) clock as External (EXT), Internal Rising Edge (INT_RISING), or Internal Falling Edge (INT_FALLING). Transmit clock is always EXT if the Timing Source is Nx64k. For more information, see “ System Timing Circuits ” on page 12.
CTS DSR RLSD	Specifies one of three methods the LTU/NTU uses to generate the Clear to Send (CTS), Data Set Ready (DSR), and Received Line Signal Detect (RLSD) control signals for the V.35/V.36 port. The V.35/V.36 port is hardware-configured as DCE. Set each of these parameters to match the requirements of the application. Choices are: <ul style="list-style-type: none"> STD (standard) - The output control signal follows the ITU standards ON (force ON) - Control signal is always ON OFF (force OFF) - Control signal is always OFF
LL/RL	Selects whether the LTU/NTU responds to (enabled) or ignores (disabled) the Local Loopback (LL) and Remote Loopback (RL) control signals. When enabled (ENA), the status of local and remote loopbacks appears on the Test display.

(a) Primary Timing Source automatically sets to Nx64k in Nx64K AUTO mode.

Table 17. *V.35/V.36/X.21 Output Control Signal Operation*

State	Condition	Control Signals	Output Data
1	HDSL link down	CTS = OFF DSR = DTR ^(a) RLSD = OFF TM = OFF	RD = all ones
2	HDSL link up	CTS = RTS ^(a) DSR = DTR ^(a) RLSD = ON TM = OFF	RD = normal data
3	Self-test or remote unit issued a loopback away from local unit	CTS = (link) DSR = OFF RLSD = (link) TM = ON	RD = (link)
4	Local unit issued any loopback	CTS = (link) DSR = ON RLSD = (link) TM = ON	RD = looped data

(a) DTR and RTS are inputs received from the customer’s DTE. RLSD performs as defined in states 1 and 2.

Configure Alarms

Use the *Config Alarms* menu to configure LTU and NTU Interface alarm parameters and the HDSL span alarm parameters. When setting alarm parameters for LTUs and NTUs, keep the following rules in mind:

- Disabled alarms do not cause LED indications and are not stored in history. Console screen menu alarm history reports are not generated.
- Minor alarms cause LED indications and are stored in history. Console screen menu alarm history reports are generated.
- Major alarms cause LED indications, actuate the line unit alarm relay, and are stored in history. Console screen menu alarm history reports are generated.
- The LTU alarm relay activates in response to a major alarm at the LTU only.
- The NTU alarm relay activates in response to a major alarm at the NTU only.
- For the duration of a major alarm, the line unit alarm relay contacts are connected as follows:
 - The C (Common) contact is connected to the NO (Normally Open) contact.
 - The NC (Normally Closed) contact is floating.
- With no alarm, the C and NC contacts are connected, and the NO contact remains floating.
- The line unit alarm relay operates in a fail-safe mode. When no power is applied to the line unit, the alarm relay C and NO contacts are connected with the NC contact floating.

Type **A** at the *Config* drop-down menu to display the *Config Alarms* menu (Figure 26).

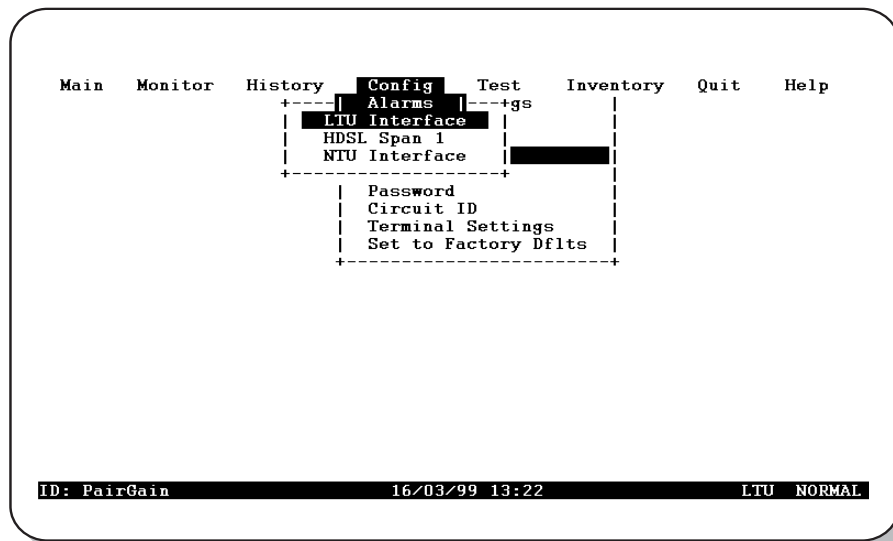

Figure 26. *Config Alarms Menu*

Alarms for LTU and NTU Interface

- 1 Type one of the following at the *Config Alarms* drop-down menu to display the *Config Alarms LTU* or *Config Alarms NTU Interface* menu:
 - **L** for the *Config Alarms LTU Interface* menu (Figure 27)
 - **N** for the *Config Alarms NTU Interface* menu (Figure 28)

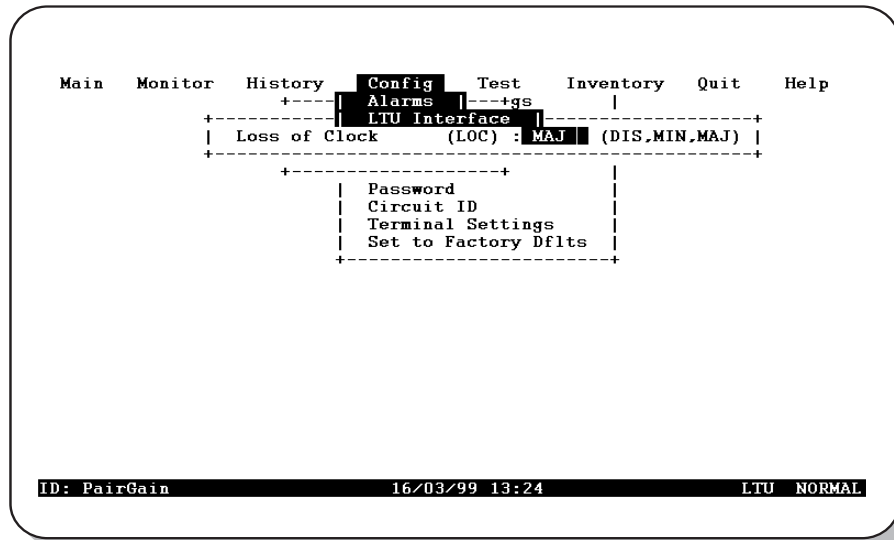

Figure 27. Config Alarms LTU Interface Menu

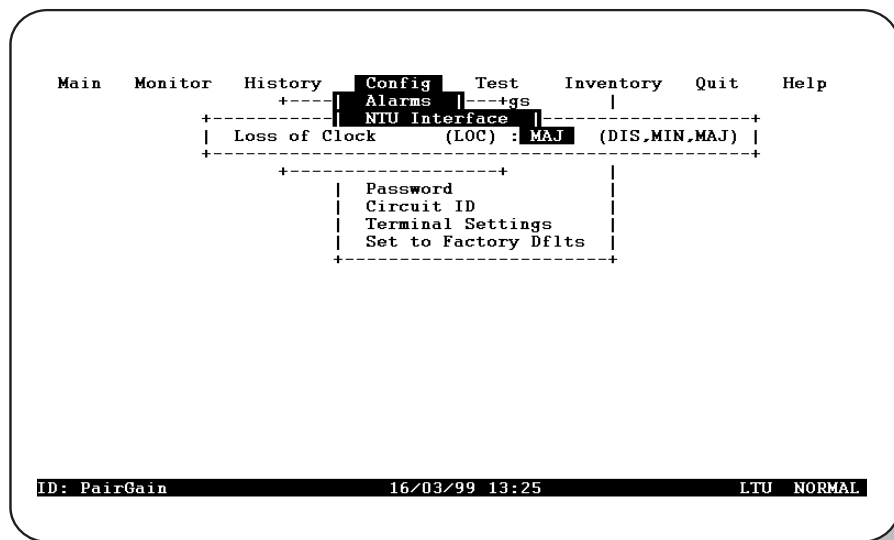

Figure 28. Config Alarms NTU Interface Menu

- 2 Do the following for each interface option to be changed. The fields displayed in the *Config Alarms LTU* and *Config Alarms NTU Interface* menus are described in Table 18.
 - Use the **↑** or **↓** key to select the sub-menu item to be changed.
 - Use the **SPACEBAR** to toggle to the appropriate option or type in the correct information, then press **ENTER** to select the option.

Table 18. Fields in Config Alarms LTU and Config Alarms NTU Interface Menus

Field	Description
Loss of Clock (LOC)	Selects whether the alarm is disabled (<i>DIS</i>), or enabled and reported as a Minor (<i>MIN</i>) or Major (<i>MAJ</i>) alarm when the LOC condition occurs. The LOC condition can occur following a loss of either the TT clock (Nx64k timing) or external clock (EXT timing). (See “System Timing Circuits” on page 12.)

HDSL Span 1 Alarms

- 1 Type **1** at the *Config Alarms* drop-down menu to display the *Config Alarms HDSL Span 1* menu (Figure 29).

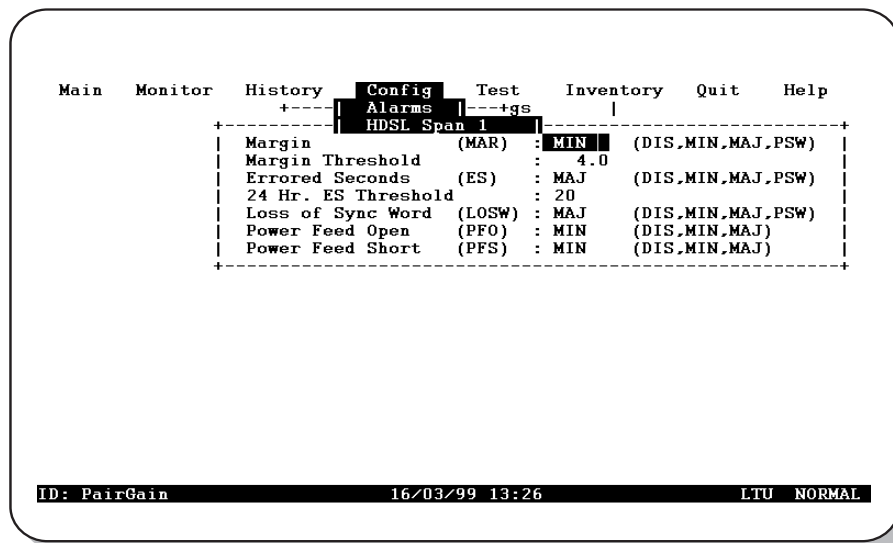

Figure 29. Config Alarms HDSL Span 1 Menu

- 2 Do the following for each interface option to be changed. The fields displayed in the *Config Alarms HDSL Span 1* menu are described in Table 19 on page 41.
 - Use the **↑** or **↓** key to select the sub-menu item to be changed.
 - Use the **SPACEBAR** to toggle to the appropriate option or type in the correct information, then press **ENTER** to select the option.

Table 19. *Fields in Config Alarms HDSL Span 1 Menu*

Field	Description
Margin (MAR)	Selects whether the alarm is disabled (<i>DIS</i>), or enabled and reported as a Minor (<i>MIN</i>) or Major (<i>MAJ</i>) Alarm when the margin falls below the threshold. This indicates a potential degradation of line quality. If an alarm is configured as a protection switch (<i>PSW</i>), it will behave as a Major (<i>MAJ</i>) Alarm, and cause protection switching to engage.
Margin Threshold	Selects the margin alarm threshold (from 0 dB to 15 dB) for all four margin measurements of the span.
Errored Seconds (ES)	Selects whether the alarm is disabled (<i>DIS</i>), or enabled and reported as a Minor (<i>MIN</i>) or Major (<i>MAJ</i>) Alarm when 24-hour ES count exceeds the threshold.
24 HR ES Threshold	Selects the errored seconds threshold (0 to 255) for all four errored seconds measurements of the span measured over a 24-hour period.
Loss of Sync Word (LOSW)	Selects whether the alarm is disabled (<i>DIS</i>), or enabled and reported as a Minor (<i>MIN</i>) or Major (<i>MAJ</i>) Alarm when the LOSW condition (HDSL loop down) occurs.
Power Feed Open	Not supported. These units do not supply power to other units.
Power Feed Short	Not supported. These units do not supply power to other units.

SET TO FACTORY DEFAULTS

Set to Factory Dflts is the screen from which all operating options can be reset to the ADC factory defaults.

- 1 Type **F** at the *Config* drop-down menu to display the *Set to Factory Dflts* screen (Figure 30).

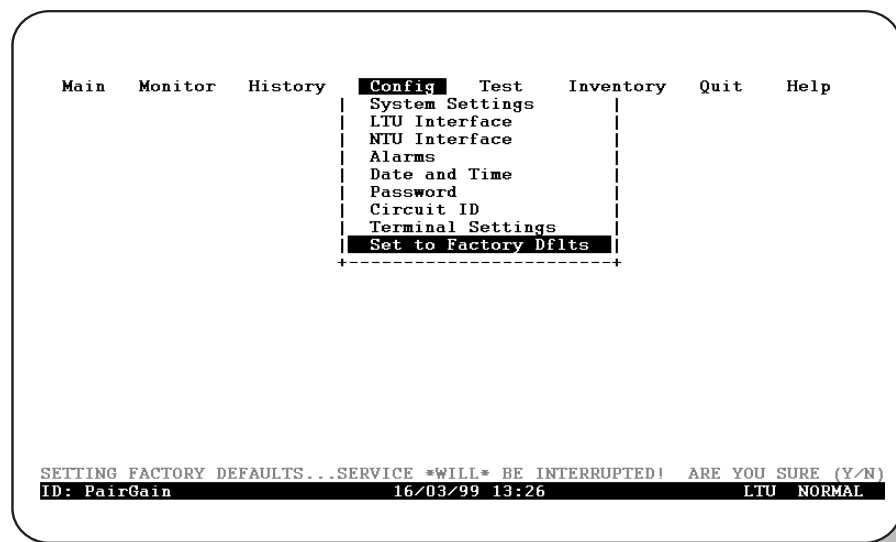

Figure 30. *Set to Factory Defaults Screen*

- 2 Press **ENTER** to reset value to factory defaults. A confirmation message appears at the bottom of the display:

SETTING FACTORY DEFAULTS ... SERVICE *WILL* BE INTERRUPTED! ARE YOU SURE (Y/N) ?

3 Do one of the following:

- Type **N** to keep the current settings.
- Type **Y** to reset values to factory defaults. The system resets and both LTU and NTU units go through their respective synchronization processes. If loops are down or are in update mode while *Set to Factory Dflts* is enabled, only the local unit will restart. If the loops are up, both the LTU and NTU will restart.

The factory default system settings are listed in [Table 20](#).

Table 20. *Factory Default System Settings*

Operating Option	Default Setting
System Settings	
Application Mode	SINGLE
HDSL Rate Mode	MANUAL
HDSL Payload Rate	256kbps/4
Remote Console Access	ALLOWED
Protect Switch Command	Not supported on these units.
Local Unit Role	NTU
LTU/NTU Interface	
Nx64k port	
Interface Type	V.36
Data Rate/# of TSs	0
Beginning TS	0
Transmit Clock	INT-RISING (Internal Rising)
CTS	STD (Standard)
DSR	STD (Standard)
RLSD	STD (Standard)
LL/RR	ENA (Enabled)
Alarms LTU/NTU Interface	
Loss of Clock (LOC)	MIN (Minor)
Alarms HDSL Spans	
Margin (MAR)	MIN (Minor)
Margin Threshold	6
Errored Seconds (ES)	MIN (Minor)
24 Hour ES Threshold	70
Loss of Sync Word (LOSW)	MAJ (Major)
Power Feed Open (PFO)	Not supported on these units.
Power Feed Short (PFS)	Not supported on these units.

LOGGING OFF

If the maintenance terminal must be left unattended for any length of time, log off until work resumes. This prevents unauthorized persons from inadvertently changing operating parameters.

Log off by choosing *Quit* from the menu bar or by disconnecting the cable connecting the maintenance terminal to the line or desktop unit. Automatic log off occurs after 20 minutes of keyboard inactivity.

VIEWING STATUS

The following sections describe the screens that display status and system information, such as current alarm status, performance history, product, and configuration information.

View status using a maintenance terminal or PC running a terminal emulation program connected to the V.24 (RS-232) console port. See [page 22](#) for instructions on connecting a maintenance terminal or PC.

MAIN CONSOLE SCREEN

The *Main* console screen displays a summary of LTU and NTU circuit configuration, performance statistics, and alarm status for each interface in the circuit.

Type **M** to display the *Main* console screen ([Figure 31](#)). The screen shown in [Figure 31](#) is a display of the LTU and NTU in the single-pair application. The numbered fields are described in [Table 21](#).

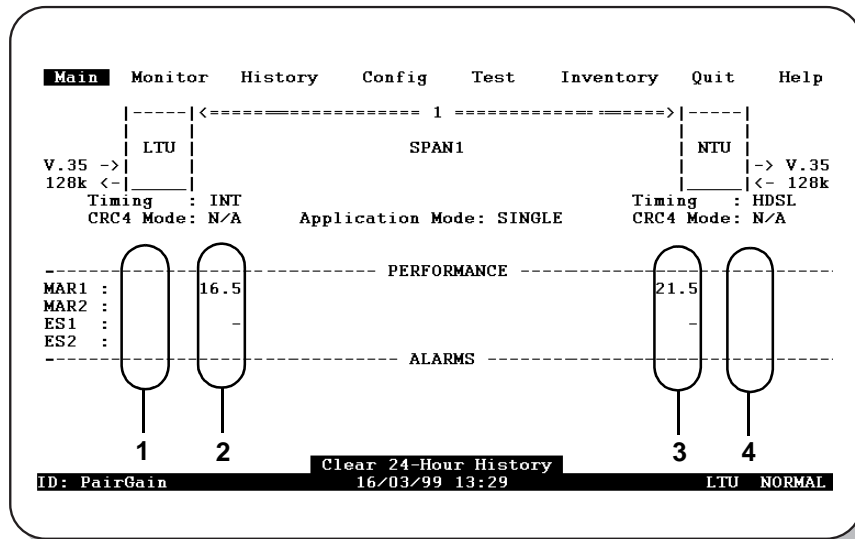

Figure 31. Main Console Screen

Table 21. Reading the Main Console Screen

Field	Description
1	Shows performance and alarms for the LTU user interface.
2	Shows performance and alarms for the LTU HDSL interface.
3	Shows performance and alarms for the NTU HDSL interface.
4	Shows performance and alarms for the NTU user interface.

Table 22 describes the fields displayed on the *Main* console screen.

Table 22. *Fields in Main Console Screen*

Field	Description
Circuit Configuration	
V.35/V.36/X.21/RS-530	Indicates the interface standard for Nx64k serial data port.
<i>n k</i>	Indicates the data rate (<i>n</i>) mapped to the Nx64k interface.
Timing	Indicates the primary source the LTU/NTU uses for clock synchronization:
INT	Internal oscillator.
EXT	External 2.048 MHz.
Nx64k	Serial data port receive clock.
HDSL	Recovered clock from received HDSL data.
Application mode	Indicates that the Single Pair (SINGLE) application mode is in effect.
Performance	
MAR1	Displays the Margin value for each HDSL interface or displays link status (SIG, ACQ, etc.) if the link is not up.
MAR2	Reserved
ES1	Displays the errored second counts for each HDSL interfaces. The counts are for the latest 24-hour period, calculated as the sum of the counts in the previous 95 15-minute intervals, plus the count in the current 15-minute interval.
ES2	Reserved
Alarms	
The Alarms field displays a list of all active alarms at each LTU/NTU and HDSL interface.	
Possible Nx64k port alarms	
LOC	Loss of incoming clock (TT) at the serial data port (only enabled if the primary timing source is Nx64k).
Possible External Clock Alarms	
LOC	Applies to loss of external clock when EXT timing is used. The external clock was lost for the previous second. This alarm is reset when the clock is active again.
Possible HDSL alarms	
MAR1	Margin threshold has fallen below alarm threshold for the HDSL interface.
ES1	Errored second count has exceeded alarm threshold for the HDSL interface.
LOSW1	Loss of sync word for the HDSL interface. Remains active during restart, but not a cold start.

MONITOR MENU

The Monitor menu contains the following options:

- LTU Interface screen that displays signal activity at the LTU serial data port.
- NTU Interface screen that displays signal activity at the NTU serial data port.
- HDSL Span 1 screen that displays 24-hour error counts and other information for the HDSL span 1 interface.

Type **0** at the console screen to display the *Monitor* menu (Figure 32).

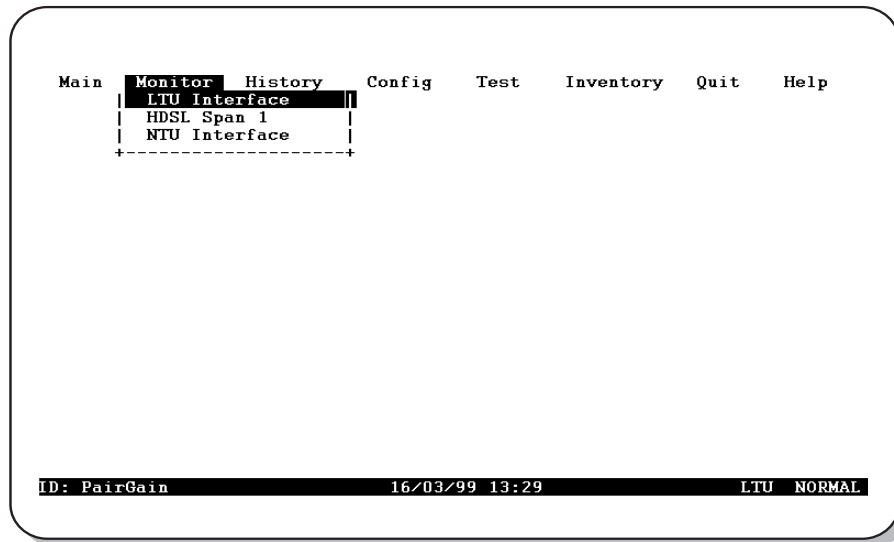

Figure 32. Monitor Menu

Monitor LTU Interface Screen

The Monitor LTU Interface screen permits viewing of signaling activity at the LTU serial data port.

At the *Monitor* menu (Figure 32), type **L** to display the *Monitor LTU Interface* screen (Figure 33). Table 23 describes the fields displayed in the *Monitor LTU* and *Monitor NTU Interface* screens.

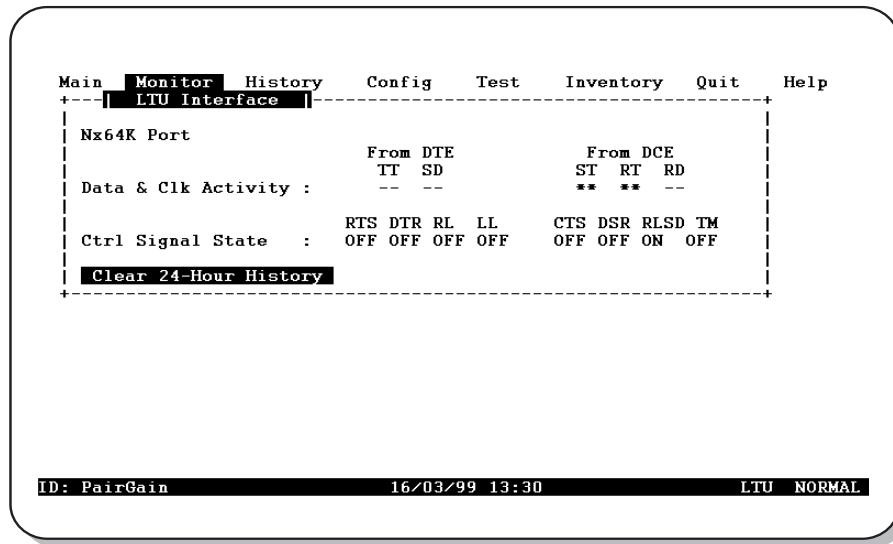

Figure 33. Monitor LTU Interface Screen

Table 23. Fields in Monitor LTU and Monitor NTU Interface Screens

Field	Description
Nx64k Port	
Data & Clk Activity	Displays the status of the TT (terminal timing), SD (transmit data), ST (send timing), RT (receive timing), and RD (receive data) signals at the Nx64k port at one-second intervals. Asterisks (**) indicate an active line. Dashes (--) indicate an inactive line. Displayed fields are: From DTE: TT SD From DCE: ST RT RD
Ctrl Signal State	Displays the status of the RTS (ready to send), DTR (data terminal ready), RL, LL, CTS, DSR, RLSD, and TM (test mode) control signals at the Nx64k port at one-second intervals. ON indicates an active line. OFF indicates an inactive line. Displayed fields are: From DTE: RTS DTR RL LL From DCE: CTS DSR RLSD TM
Clear 24Hour History	Not available from this screen on Nx64k serial data port units. Use clear history options in console screen History menu. (For more information, see “History Menu” on page 49.)

Monitor NTU Interface Screen

The Monitor NTU Interface screen permits viewing of signaling activity at the NTU serial data port.

At the *Monitor* menu (Figure 32), type **N** to display the *Monitor NTU Interface* screen (Figure 34).

```

Main  Monitor  History  Config  Test  Inventory  Quit  Help
+---+
|  Monitor  |
|  NTU Interface  |-----+
|
| Nx64K Port
|
|           From DTE           From DCE
|           TT  SD             ST  RT  RD
| Data & Clk Activity :      --  --             --  --  --
|
| Ctrl Signal State :   RTS DTR RL  LL   CTS DSR RLS D TM
|                   OFF OFF OFF OFF   OFF OFF OFF OFF
|
| Clear 24-Hour History
|-----+
|
| ID: PairGain           16/03/99 13:31           LTU  NORMAL

```

Figure 34. Monitor NTU Interface Screen

The fields displayed in the Monitor NTU Interface screen are identical to those displayed in the Monitor LTU Interface screen (see Table 23 on page 46).

Monitor HDSL Span 1 Screen

The Monitor HDSL Span 1 screen permits viewing of the 24-hour error counts for the HDSL span. A span is defined as the link between two HDSL units (that is, from an LTU to an NTU) which, in this case, is comprised of a single loop (that is, one twisted-copper pair). The values under the LTU-1 column represent HDSL Span 1 as measured by the LTU. The values under the NTU-1 column represent HDSL Span 1 as measured by the NTU.

At the *Monitor* menu (Figure 32), type **1** to select the *Monitor HDSL Span 1* screen (Figure 35). The fields displayed in the *Monitor HDSL Span 1* screen are described in Table 24.

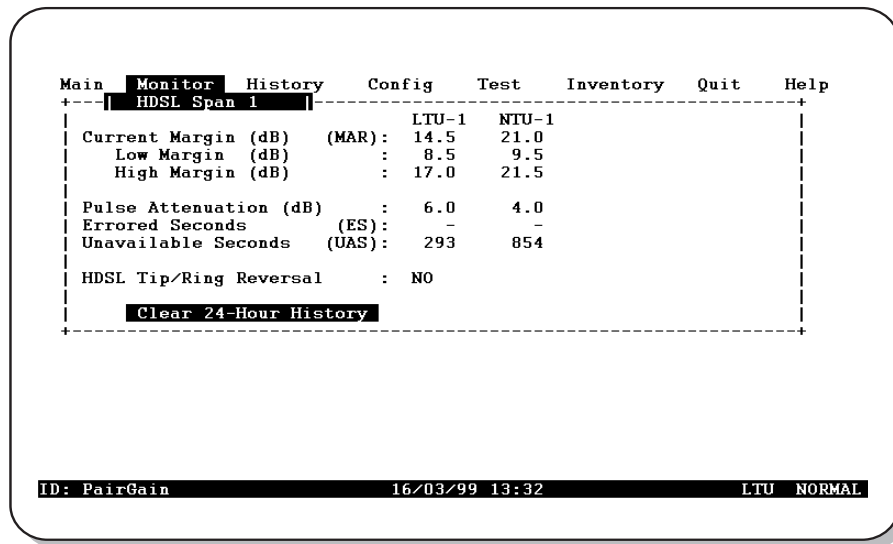

Figure 35. Monitor HDSL Span 1 Screen

Table 24. Fields in Monitor HDSL Span 1 Screen

Field	Description
Current Margin (dB) (MAR)	Indicates the excess signal-to-noise ratio relative to a 10^{-7} bit error rate. The normal range of a typical margin is from 6 to 22 dB, with a value of 6 dB corresponding to a predicted BER of 10^{-10} .
Low Margin (dB)	Indicates the lowest margin since startup or the last 24-hour history clear.
High Margin (dB)	Indicates the highest margin since startup or the last 24-hour history clear.
Pulse Attenuation (dB)	Indicates the attenuation of the 2B1Q pulse from the distant end. This value is related to the cable pair's loss at 292 KHz. The normal range of pulse attenuation is from 1 to 41 dB.
Errored Seconds (ES)	The number of one-second intervals in which at least one HDSL CRC-6 error or loss of Sync Word (LOSW) was detected on the HDSL span during the last 24 hours.
Unavailable Seconds (UAS)	The number of seconds that the HDSL span was down during the last 24 hours.
HDSL Tip/Ring Reversal	Indicates whether the two conductors of the HDSL span are correctly connected or have been interchanged. The system automatically compensates for an interchange of wire leads.
Clear 24 Hour History	Not available from this screen on Nx64k serial data port units. Use clear history options in console screen History menu. (For more information, see "History Menu" on page 49.)

HISTORY MENU

The History menu contains the following status screens:

- LTU/NTU Interfaces that display alarm performance history for the LTU and NTU interface.
- HDSL Span that displays 24-hour, 7-day, and alarm performance history for the HDSL span.

The History menu also provides the option to clear the 24-hour, 7-day, and alarm history screens. This option is described on [page 55](#).

Type **H** to select the *History* menu ([Figure 36](#)).

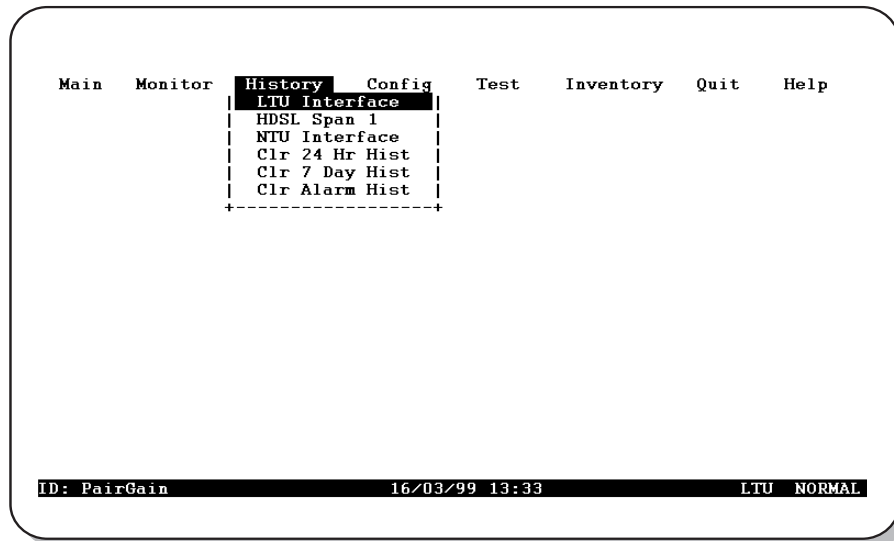

Figure 36. *History Menu*

History LTU and NTU Interface Screens

At the *History* menu (Figure 36), type **L** to select the *History LTU Interface* menu (Figure 37).

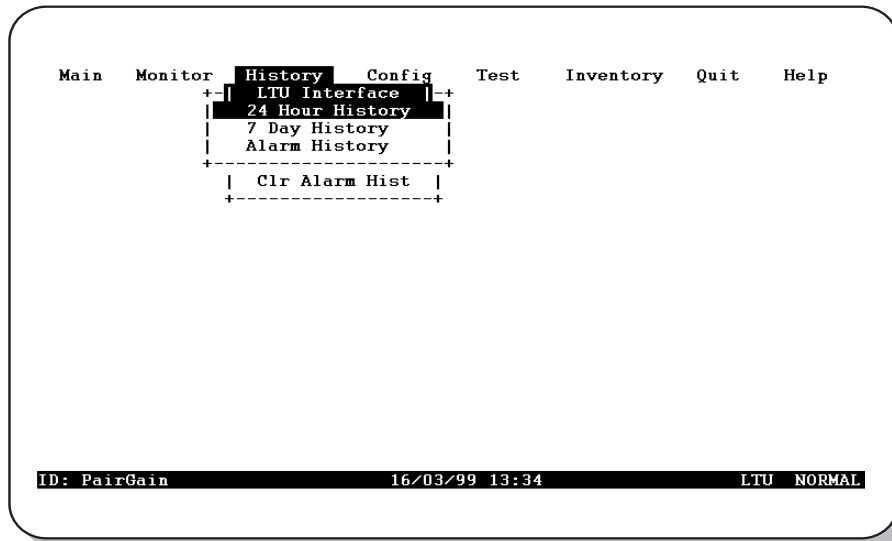

Figure 37. History LTU Interface Menu

At the *History* menu (Figure 36), type **N** to select the *History NTU Interface* menu (Figure 38).

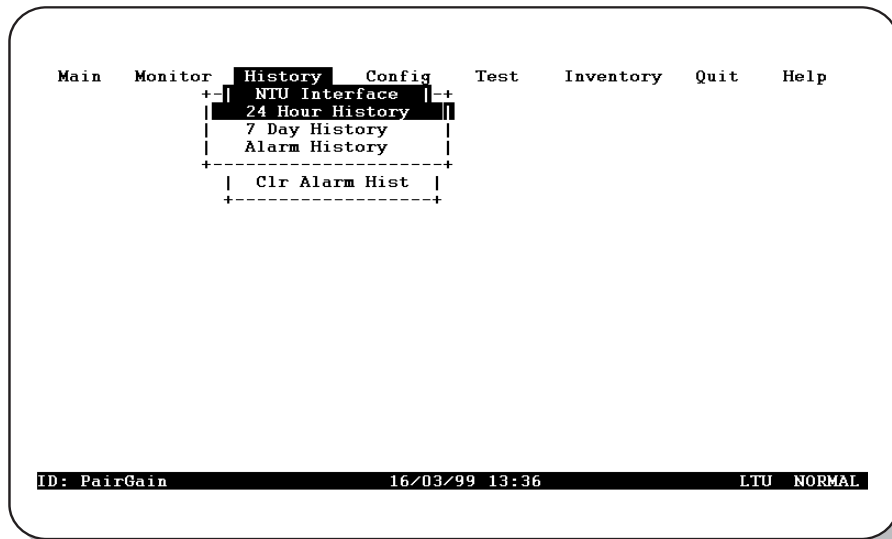

Figure 38. History NTU Interface Menu



Only the Alarm History screen (Figure 39) is available for the LTU and NTU interfaces. The 24 Hour and 7 Day History screens, as well as the Alarm History screen, are available for HDSL Span 1 (see Figure 40 on page 52).

LTU and NTU Interface Alarm History Screens

At the *History LTU* or *History NTU Interface* menu, type the **A** key to select an *Alarm History* status screen. The *LTU Interface Alarm History* screen is shown in [Figure 39](#).

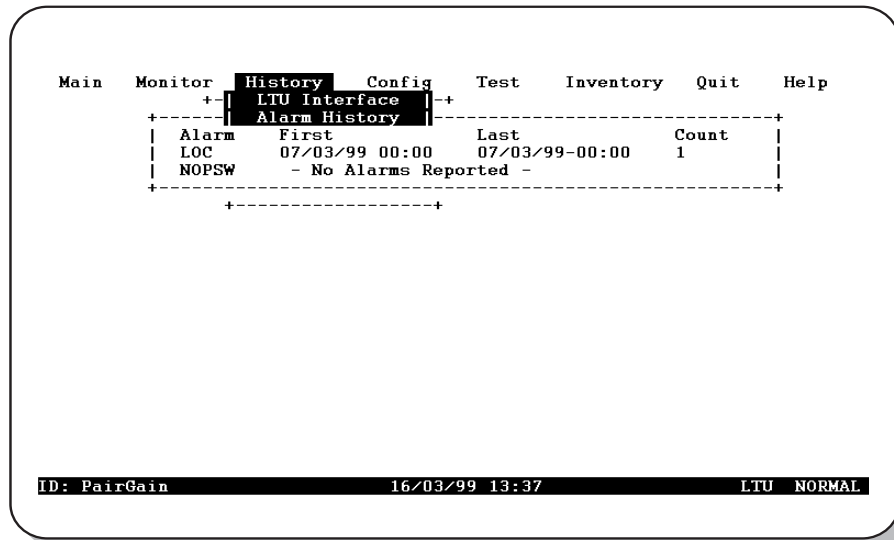

Figure 39. *LTU Interface Alarm History Screen*

[Table 25](#) describes the four columns of data contained in the LTU Interface and NTU Interface Alarm History screens. If no alarm has occurred since the last alarms were cleared, the message "No alarms reported" displays on the appropriate line for each alarm.

Table 25. *LTU Interface and NTU Interface Alarm History Data*

Column	Description
Alarm	Type of alarm: LOC (Loss of Clock), NOPSW ^(a) (No Protection Switch)
First	Date and time the alarm first occurred.
Last	Date and time the alarm last occurred.
Count	Number of times the alarm has occurred since the alarms were last cleared.

(a) Not available on Nx64k serial data port units.

HDSL Span Performance History Screens

At the *History* menu (Figure 36), type **1** to select the *History HDSL Span 1* menu (Figure 40).

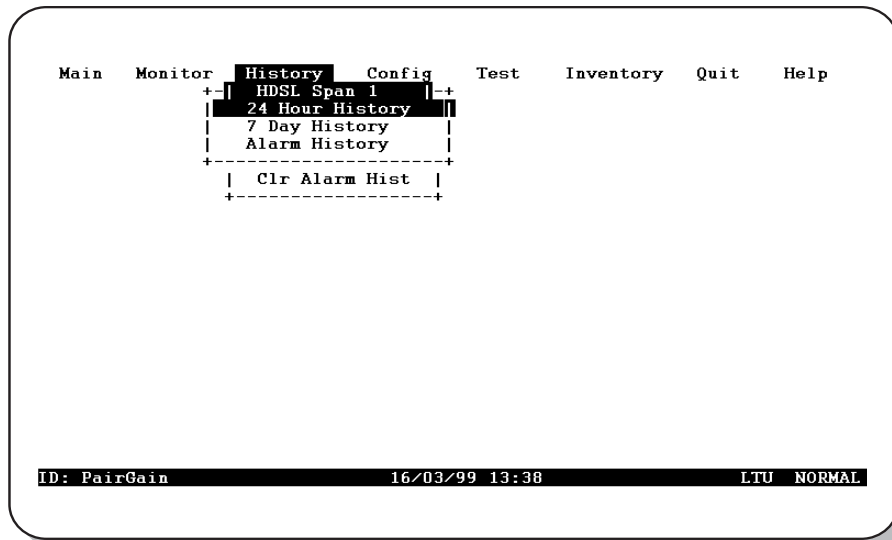

Figure 40. History HDSL Span 1 Menu

The *History HDSL Span 1* menu contains three viewing options:

- 24 Hour History
- 7 Day History
- Alarm History

HDSL Span 1 24 Hour History Screen

At the *History HDSL Span 1* menu (Figure 40), type **H** to select the *24 Hour History* screen for HDSL Span 1 (Figure 41).

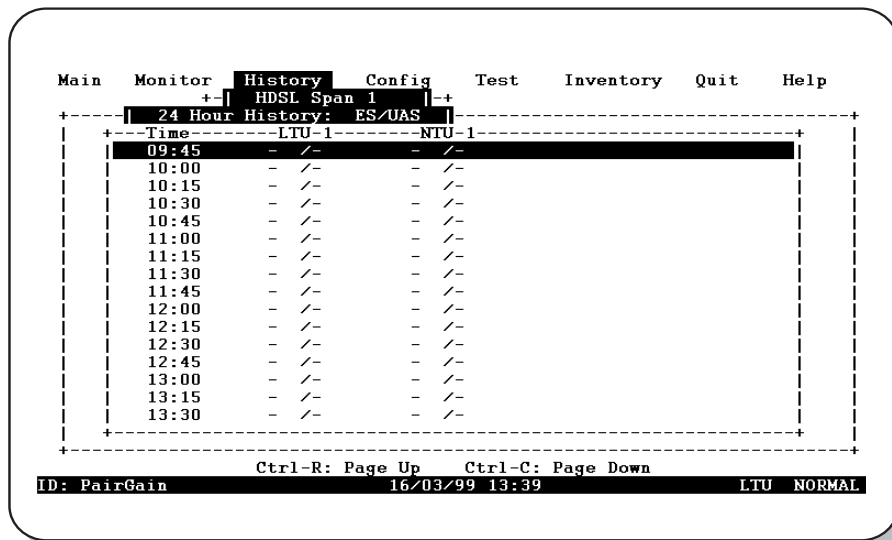

Figure 41. 24 Hour History Screen for HDSL Span 1

The *24 Hour History* screen for *HDSL Span 1* contains three columns of data that show (from left to right) the:

- Starting time of each 15-minute interval.
- Number of ES/UAS at the LTU end of the HDSL span (LTU-1) for each interval. A dash (-) represents a count of zero.
- Number of ES/UAS at the NTU end of the HDSL span (NTU-1) for each interval. A dash (-) represents a count of zero.

The entire display consists of six screens, each showing sixteen 15-minute intervals (4 hours) of performance history.

Type **CTRL + R** or **CTRL + C** to display the previous or next screen in the sequence, respectively. Press the **↑** or **↓** key to scroll the screen up or down by one line, respectively.

7 Day HDSL Span 1 Performance History Screens

At the *History HDSL Span 1* menu (Figure 40), type **D** to select the *7 Day History* status screen for HDSL Span 1 (Figure 42).

Date	LTU-1	NTU-1
09/03	-	-
10/03	-	-
11/03	-	-
12/03	-	-
13/03	-	-
14/03	-	-
15/03	-	-
16/03	/293	/854

ID: PairGain 16/03/99 13:40 LTU NORMAL

Figure 42. 7 Day History Status Screen for HDSL Span 1

Each HDSL Span 7-Day History screen contains three columns of data showing (from left to right) the:

- Date of each completed day within the 7-day interval.
- Number of ES/UAS at the LTU end of the HDSL span (LTU-1) for each interval. A dash (-) represents a count of zero.
- Number of ES/UAS at the NTU end of the HDSL span (NTU-1) for each interval. A dash (-) represents a count of zero.

HDSL Span 1 Alarm History Screens

At the *History HDSL Span 1* menu (Figure 40), type **A** to select the *Alarm History* status screen for HDSL Span 1 (Figure 43).

```

Main  Monitor  History  Config  Test  Inventory  Quit  Help
      +-+-----+-----+-----+-----+-----+-----+-----+
      | HDSL Span 1 |
      | Alarm History |
      +-----+-----+-----+-----+-----+-----+
      | Alarm      | First      | Last      | Count     |
      | MAR1       | - No Alarms Reported - |
      | ES1        | - No Alarms Reported - |
      | LOSW1      | 07/03/99 00:00   | 07/03/99-00:00   | 1          |
      | PFO1       | - No Alarms Reported - |
      | PFS1       | - No Alarms Reported - |
      +-----+-----+-----+-----+-----+-----+

ID: PairGain          16/03/99 13:42          LTU  NORMAL
  
```

Figure 43. Alarm History Status Screen for HDSL Span 1

Table 26 describes the four columns of data contained in each HDSL Span Alarm History screen.

Table 26. HDSL Span Alarm History Data

Column	Description
Alarm	Type of alarm: MAR1 (Margin Span 1), ES1 (Errored Seconds Span 1), LOSW1 (Loss of Sync Word Span 1), PFO1 ^(a) (Power Feed Open Span 1), PFS1 ^(a) (Power Feed Short Span 1).
First	Date and time the alarm first occurred.
Last	Date and time the alarm last occurred.
Count	Number of times the alarm has occurred since the alarms were last cleared.

(a) Not supported. These units do not supply power to other units.

If no alarm has occurred since the last alarms were cleared, the message "No alarms reported" displays on the appropriate line for each alarm.

Clear History Screens

Use the following options to clear the 24 Hour, 7 Day, or Alarm History status screens:

- Clr 24 Hr Hist: clears all of the 24-hour history error counters
- Clr 7 Day Hist: clears all of the 7-day history error counters
- Clr Alarm Hist: clears all alarm history logs

To clear the status screens:

- 1 Select the alarm history option to be cleared with the **↑** and **↓** keys, then press **ENTER**. The following confirmation message displays:

```
ALL ( 24-HOUR , or 7 DAY , or ALARM ) HISTORIES WILL BE CLEARED . CONTINUE ( Y/N ) ?
```

- 2 Do one of the following:

- Type **N** to cancel the operation.
- Type **Y** to clear the screen. Typing **Y** displays the following confirmation message:

```
24-HOUR HISTORIES CLEARED
```

INVENTORY SCREEN

The Inventory screen permits tracking of the system's inventory, service, and revision state. [Table 27 on page 56](#) describes the fields displayed in each Inventory screen. Type **I** to display the *Inventory* screen ([Figure 44](#)).

```

Main  Monitor  History  Config  Test  Inventory  Quit  Help
-----|-----|-----|-----|-----|-----|-----|-----|
          |-----|<----- 1 ----->|-----|
          |  LTU  |                   SPAN1  |         NTU  |
V.35 ->|-----|                   |-----|>- V.35
128k <-|-----|                   |-----|<- 128k

Product : UTU-702                UTU-702
List #   : 1                      1
H/W Cfg  : -                       -
Serial # : -                       -
Manuf    : 01/03/99                01/03/99
Days Op  : 1                        1
SW Part# : xxx-xxxx-xx              xxx-xxxx-xx
Checksum : B54B                     0BF5
S/W Rev  : V04.0                     V04.0
SW Date  : 17/03/99                 17/03/99

ID: PairGain                16/03/99 13:43                LTU NORMAL

```

Figure 44. Inventory Screen

Table 27. Inventory Screen Data

Field	Description
Network Diagram	Displays the configuration of the LTU or NTU circuit.
Product	Displays the model numbers of the LTU, NTU, and any doubler units that comprise the channel.
List #	Displays the LTU, NTU, and doubler unit list numbers, which identify the particular unit versions.
H/W Cfg	Displays the LTU, NTU, and doubler unit hardware configuration level.
Serial #	Displays the unique serial number of the LTU, NTU and any doubler units for inventory and service tracking.
Manuf	Displays the date the LTU, NTU, and any doubler units were manufactured.
Days Op	Displays the number of days the LTU, NTU, and any doubler units have been in operation.
SW Part #	Displays the ADC part number of the firmware.
Chksum	Displays the checksum of the LTU, NTU, and doubler unit prompts.
S/W Rev	Displays the currently installed firmware version level of the LTU, NTU and any doubler units.
SW Date	Displays the date that the firmware was released.

TESTING

From the main console screen (Figure 31), type **T** to display the *Test* menu from which you can set and run loopback and BER tests (Figure 45).

```

Main  Monitor  History  Config  Test  Inventory  Quit  Help
      |
      | <----- 1 ----->
      |
      |   LTU                               SPAN1                               NTU
      |   U.35 ->                               -> U.35
      |   384k <-                               <- 384k
      |   Timing : INT                               Timing : HDLSL
      |   CRC4 Mode: N/A                               CRC4 Mode: N/A
      |
      |----- Network ----- Customer -----
      |
      | Lpbk Dir : OFF (OFF, NETWORK, CUSTOMER)
      | Lpbk Loop(s) : NONE (NONE)
      | Lpbk Position: NONE (NONE)
      | Lpbk Timeout : 20 MIN (NONE, 20 MIN, 2 HR)
      |
      |-----
      | BER Test : STOP (STOP, RESTART)
      | Det. Status : NOT ACTIVE
      | Test Time : 00:00:00
      | Bit Errors : 0
      | BER : 0.0
      |
      | ID: PairGain                               17/03/99 11:53                               LTU NORMAL
  
```

Figure 45. Test Menu Screen

Table 28 on page 58 lists the *Test* menu options. Table 29 lists the fields displayed in the Bit Error Rate (BER) section of the test menu.

Loopbacks remain active until the timeout elapses or the configuration changes. The loopback location and status are indicated on the network diagram portion of the test menu, with "@"@]" characters as follows:

- Flashing reverse video for active loopbacks
- Solid reverse video for disabled loopbacks

Front panel loopback (LPBK) LED indications are described in Table 4 on page 6. See page 16 for a description of loopbacks.

Table 28. Test Menu Options

Operating Option	Default Setting
Network Diagram	Shows the loopback position and direction when the loopback is enabled and active.
Lpbk Dir	Selects one of three loopback direction modes:
OFF	No loopbacks are active.
NETWORK	The loopback selected in Loopback Position is directed toward the network equipment connected to the LTU.
CUSTOMER	The loopback selected in Loopback Position is directed toward the customer's equipment connected to the NTU.
Lpbk Loop(s)	Selects the loops used in the loopback test:
NONE	Option not available with single-pair HDSL card.
Lpbk Position	Selects the possible loopback positions:
NONE	Option not available with single-pair HDSL card.
Lpbk Timeout	Selects one of three loopback timeouts:
NONE	Disables automatic timeout cancellation of all loopbacks.
20	Automatically cancels any loopback 20 minutes after initiation.
120	Automatically cancels any loopback 120 minutes after initiation.

Table 29. BER Section of Test Menu

Field	Description
BER Test	Selects the state of the BER test.
STOP	Terminates the current test and resumes normal transmission of user payload. Prior BER tests are maintained for reference on the screen. <i>STOP</i> must be selected to terminate the BER test prior to exiting the screen.
RESTART	Begins BER test. This disrupts user payload traffic and inserts a pseudo-random bit sequence (PRBS) at the LTU toward the NTU. The actual pattern used is a 2×10^{15} pattern as defined by reselecting this option (pressing the ENTER key) while the test is running. This entry reinitiates the BER values and restarts the test.
Det. Status	Displays the current status of the BER detector at the LTU.
NOT ACTIVE	Displays while the BER is not running.
SYNCING	Indicates that the BER qualification period is in progress (128 received bits are compared to the PRBS).
IN SYNC	Indicates that the BER test is in progress. The BER meter accumulates errors once per test interval (16 seconds). In a high bit error environment the test interval is shortened and the BER meter is updated every second.
Test Time	Displays the elapsed test time for the BER test.
Bit Errors	Displays the number of bits received that did not match the PRBS pattern. This field is updated every 30 seconds, with a maximum value of 255 per update.
BER	Displays the Bit Error Rate computer for the current test. This field is updated every 16 seconds, as is displayed in exponential form. The lowest positive displayable value is 1×10^{-11} .

FIRMWARE DOWNLOAD UTILITY



The Firmware Download Utility is a separate program and is not available from the console screen menus.

This section describes the ETSI Firmware Download utility and how to use it to upgrade the line unit firmware. The ETSI Firmware Download utility is a program you can run on a PC to download new firmware to the LTU or NTU by connecting a standard RS-232 interface cable to the unit front panel V.24 console port. When using the ETSI Firmware Download utility, follow these rules:

- Make sure the destination unit where the new firmware is to be upgraded is correct before pressing the **ENTER** key.
- Do not disconnect the interface cable during the download process.
- Do not abort the download once it has started.

Figure 46 shows the menu for the ETSI Firmware Download Utility. The upper area of the ETSI Firmware Download Utility menu displays the configuration options, and the lower area displays messages during the download process.

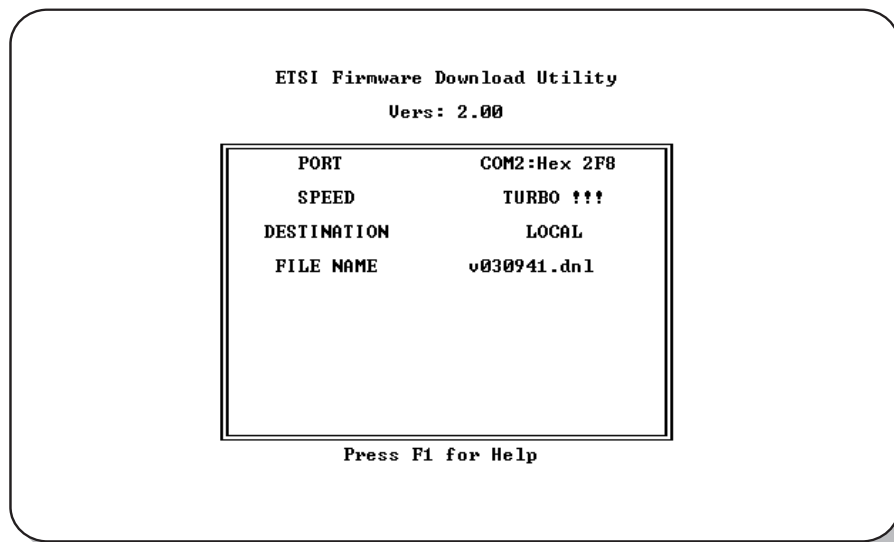

Figure 46. ETSI Firmware Download Utility Menu

Initiate the Download and Navigate the Menus

To initiate the download process, go to the DOS prompt and type: `dn1` . [Table 30](#) describes ETSI Firmware User Selectable Download Menu Options.

Table 30. *ETSI Firmware User Selectable Download Menu Options*

Option	Description
PORT	Provides support for two communication ports: COM1 at Hex 3F8 COM2 at HEX 2F8
SPEED	Supports <i>Standard</i> (9600 bit/s), <i>Medium</i> (19.2K kbps), <i>Fast</i> (38.4 kbps), <i>Faster</i> (57.6 kbps) and <i>TURBO</i> (115.2 kbps) speeds. The number of data bits is fixed at 8, with no parity and 1 stop bit.
DESTINATION	The destination can be set to one of the following: <i>LOCAL</i> (unit connected to the maintenance terminal) <i>LTU</i> (LTU unit) <i>NTU</i> (NTU unit) <i>NTU2</i> (NTU2 unit, in case of point-to-multipoint download) <i>REGENERATOR1</i> <i>REGENERATOR2</i>
FILE NAME (*)	Enter the firmware download file name.

(*) FILE NAME can be changed by pressing the **DEL** key, then typing the new file name. Once in the FILE NAME field, the download setup can be aborted only by typing **CTRL + C** . After typing the new file name, press the **ENTER** key to start the download sequence.

[Table 31](#) describes how to navigate within the ETSI Firmware Download menu.

Table 31. *Navigating the ETSI Firmware Download Menu*

Keystroke	Result
PAGE UP or PAGE DOWN	Change a setting, with the exception of the FILE NAME setting.
↑ and ↓	Move from field to field.
ESC	Abort setup and returns to the DOS prompt.
ENTER	Start the download process.

Download progress messages include:

- program size
- download time
- program checksum
- line-unit response
- time out message (posted if the line unit does not response within five seconds; when this occurs, the download operation is aborted).

While downloading, the line or desktop unit front panel LEDs all light, then a binary count sequence indicates progress. When downloading is complete, the unit resets.

REFERENCE INFORMATION

This section lists the pinouts for the ETU-752C rear panel connectors and the ECA-80x connector adapters.

ETU-752C CONNECTOR PINOUTS

The pinouts for the ETU-752C rear panel connectors are listed in [Table 32](#) and [Table 33](#).

Table 32. *D9F HDSL Line Connector Pinouts*

Pin (*)	Signal	Description
4	HDSL_RING_A	HDSL Loop 1 (Ring)
9	HDSL_TIP_A	HDSL Loop 1 (Tip)
1	HDSL_RING_B	HDSL Loop 2 (Ring)
6	HDSL_TIP_B	HDSL Loop 2 (Tip)

(*) All other pins are not used. Pins 1 and 6 not used on single-pair HDSL cards.

Table 33. *D25F Data Port Connector Pinouts*

Pin (*)	Signal Name	V.35	V.36	X.21	DCE Input/Output
7	Signal Ground	SG	SG	SG	
2 14	Send Data	SD_A SD_B	SD_A SD_B	T_A T_B	Input
3 16	Receive Data	RD_A RD_B	RD_A RD_B	R_A R_B	Output
15 12	Send Timing	SCT_A SCT_B	ST_A ST_B	S_A S_B	Output
17 9	Receive Timing	RCT_A RCT_B	RT_A RT_B	not used	Output
24 11	Terminal Timing	SCTE_A SCTE_B	TT_A TT_B	TT_A TT_B	Input
5 13	Clear to Send	CTS	CTS	not used	Output
6 22	Data Set Ready	DSR	DSR	not used	Output
8 10	Received Line Signal Detect	RLSD	RLSD	I_A I_B	Output
25	Test Mode	TM	TM	not used	Output
4 19	Request to Send	RTS	RTS	C_A C_B	Input
20 23	Data Terminal Ready	DTR	DTR	not used	Input
18	Local Loopback	LL	LL	not used	Input
21	Remote Loopback	RL	RL	not used	Input

(*) All other pins are not used.

ECA-800 CONNECTOR ADAPTER (DB25M TO M34F FOR V.35)

The ECA-800 connector adapter (Figure 47) converts the DB25F data port connector on the desktop unit rear panel to a standard V.35 34-pin female connector. Table 34 lists the ECA-800 pinouts.

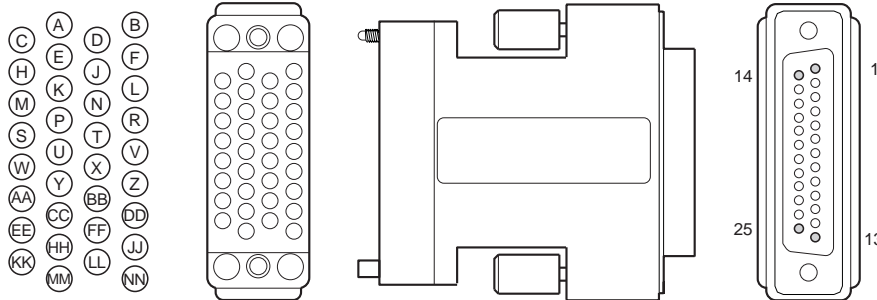

Figure 47. ECA-800 DB25M to M34F (V.35) Connector Adapter, Part Number 150-1470-01

Table 34. ECA-800 DB25M to M34F (V.35) Connector Adapter Pinouts

DB25M Connector		M34F (V.35) Connector	
Signal	Pin	Pin	Signal
Shield	1	A	Frame ground
Send Data A	2	P	Send Data A
Send Data B	14	S	Send Data B
Receive Data A	3	R	Receive Data A
Receive Data B	16	T	Receive Data B
Request to Send A	4	C	Request to Send
Clear to Send A	5	D	Clear to Send
Data Set Ready A	6	E	Data Set Ready
Data Terminal Ready A	20	H	Data Terminal Ready
Signal Ground	7	B	Signal Ground
Received Line Signal Detect A	8	F	Received Line Signal Detect
Send Timing A	15	Y	Serial Clock Transmit A
Send Timing B	12	AA	Serial Clock Transmit B
Receive Timing A	17	V	Serial Clock Receive A
Receive Timing B	9	X	Serial Clock Receive B
Terminal Timing A	24	U	Serial Clock Transmit External A
Terminal Timing B	11	W	Serial Clock Transmit External B
Local Loopback	18	L	Local Loopback
Remote Loopback	21	N	Remote Loopback
Test Mode	25	NN	Test Mode

ECA-801 CONNECTOR ADAPTER (DB25M TO DB15F FOR X.21)

The ECA-801 connector adapter (Figure 48) converts the DB25F data port connector on the desktop unit rear panel to a standard X.21 15-pin female connector. Table 35 lists the ECA-801 pinouts.

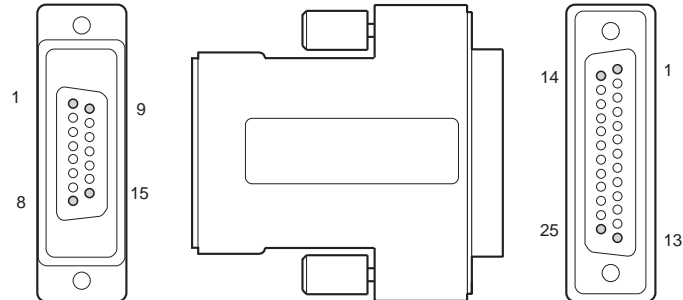

Figure 48. ECA-801 D25M to DB15F (X.21) Connector Adapter, Part Number 150-1470-01

Table 35. ECA-801 DB25M to DB15F (X.21) Connector Adapter Pinouts

DB25M Connector		DB15F (X.21) Connector	
Signal	Pin	Pin	Signal
Send Data A	2	2	Send Data A
Send Data B	14	9	Send Data B
Receive Data A	3	4	Receive Data A
Receive Data B	16	11	Receive Data B
Request to Send A	4	3	Control A
Request to Send B	19	10	Control B
Signal Ground	7	8	Signal Ground
Receive Line Signal Detect A	8	5	Indication A
Receive Line Signal Detect B	10	12	Indication B
Receive Timing A	17	6	Signal Element Timing A
Receive Timing B	9	13	Signal Element Timing B
Terminal Timing A	24	1	DTE Signal Element Timing A
Terminal Timing B	11	15	DTE Signal Element Timing A

ECA-802 CONNECTOR ADAPTER (DB9M TO RJ-45)

The ECA-802 connector adapter (Figure 49) converts the DB9F HDSL line connector on the desktop unit rear panel to an RJ-45 modular style connector. Table 36 lists the ECA-802 pinouts.

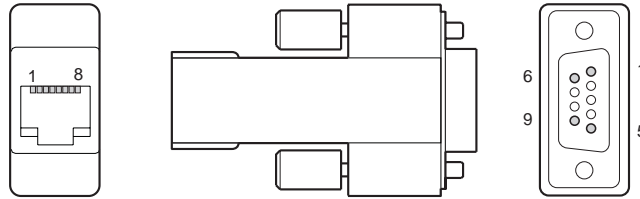

Figure 49. ECA-802 DB9M to RJ-45 Connector Adapter, Part Number 150-1472-01

Table 36. ECA-802 DB9M to RJ-45 Connector Adapter Pinouts

DB9M Connector		RJ-45 Connector	
Signal	Pin (*)	Pin (*)	Signal
HDSL Loop 1 (Ring)	4	1	HDSL Loop 1 (Ring)
HDSL Loop 1 (Tip)	9	2	HDSL Loop 1 (Tip)
HDSL Loop 2 (Ring)	1	4	HDSL Loop 2 (Ring)
HDSL Loop 2 (Tip)	6	5	HDSL Loop 2 (Tip)

(*) Pins 1, 6, 4, and 5 not used on single-pair HDSL cards.

ECA-804 CONNECTOR ADAPTER (DB9M TO FOUR-POSITION TERMINAL BLOCK)

The ECA-804 connector adapter (Figure 50) converts the DB9F HDSL line connector on the desktop unit rear panel to a four-position terminal-block style connector. Table 37 lists the ECA-804 pinouts.

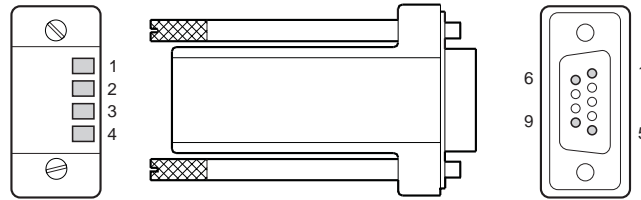

Figure 50. ECA-804 DB9M to Four-Position Terminal Block Connector Adapter, Part Number 150-1474-01

Table 37. ECA-804 DB9M to Four-Position Terminal Block Connector Adapter Pinouts

Four-Position Terminal Block		D9M Connector	
Signal	Pin (*)	Pin (*)	Signal
HDSL Loop 1 (Ring)	1	4	HDSL Loop 1 (Ring)
HDSL Loop 1 (Tip)	2	9	HDSL Loop 1 (Tip)
HDSL Loop 2 (Ring)	3	1	HDSL Loop 2 (Ring)
HDSL Loop 2 (Tip)	4	6	HDSL Loop 2 (Tip)

(*) Pins 3, 4, 1, and 6 not used on single-pair HDSL cards.

PRODUCT SUPPORT

ADC Customer Service Group provides expert pre-sales and post-sales support and training for all its products.

Technical support is available 24 hours a day, 7 days a week by contacting the ADC Technical Assistance Center (TAC).

Sales Assistance 800.366.3891 extension 73000 (USA and Canada) 952.917.3000 Fax: 952.917.3237	<ul style="list-style-type: none"> • Quotation Proposals • Ordering and Delivery • General Product Information
Systems Integration 800.366.3891, extension 73000 (USA and Canada) 952.917.3000	<ul style="list-style-type: none"> • Complete Solutions (from concept to installation) • Network Design and Integration Testing • System Turn-Up and Testing • Network Monitoring (upstream or downstream) • Power Monitoring and Remote Surveillance • Service/Maintenance Agreements • Systems Operation
ADC Technical Assistance Center 800.638.0031 714.730.3222 Fax: 714.730.2400 Email: wsd_support@adc.com	<ul style="list-style-type: none"> • Technical Information • System/Network Configuration • Product Specification and Application • Training (product-specific) • Installation and Operation Assistance • Troubleshooting and Repair/Field Assistance
Online Technical Support	<ul style="list-style-type: none"> • www.adc.com/Knowledge_Base/index.jsp
Online Technical Publications	<ul style="list-style-type: none"> • www.adc.com/library1/
Product Return Department 800.366.3891 ext. 73748 or 952.917.3748 Fax: 952.917.3237 Email: repair&return@adc.com	<ul style="list-style-type: none"> • ADC Return Material Authorization (RMA) number and instructions must be obtained before returning products.
<i>All 800 lines are toll-free in the USA and Canada.</i>	

ABBREVIATIONS

AIS	Alarm Indication Signal	LL	Local Loopback
ALM	Alarm	LOC	Local
ANSI	American National Standards Institute	LOC	Loss of Clock
AWG	American Wire Gage	LOSW	Loss of Sync Word
BER	Bit Error Rate	LPBK	Loopback
C	Centigrade	LTU	Line Termination Unit
COM	Communication	M34F	M-type 34-pin Female Connector
CRC	Cyclic Redundancy Check	MAR	Margin
CTS	Clear To Send	Mbps	Megabits per second
D15F	D-type 15-pin Female Connector	MHz	Megahertz
D25F	D-type 25-pin Female Connector	mm	millimeter
D9F	D-type 9-pin Female Connector	NC	Normally Closed
dB	Decibel	NO	Normally Open
DCE	Data Communications Equipment	NTU	Network Termination Unit
Det	Detector	NVRAM	Non-volatile Random Access Memory
dnl	Download	Nx64k	Number (N) of 64 kbps DS0 time slots mapped to a data port.
DS0	Digital Service, Level 0 (64 kbps)	Op	Operation
DSR	Data Set Ready	PFO	Power Feed Open
DTE	Data Terminal Equipment	PFS	Power Feed Short
DTR	Data Terminal Ready	ppm	pulse per minute
EMC	Electromagnetic Compliance	PRBS	Pseudorandom Bit Sequence
EMI	Electromagnetic Interference	RAM	Random Access Memory
EMS	Exchange Office Management Shelf	REM	Remote
EMU	Exchange Office Management Unit	RL	Remote Loopback
ES	Errored Second	RLSD	Received Line Signal Detector
ETR	ETSI Technical Report	RTS	Ready to Send
ETSI	European Telecommunications Standards Institute	S/W	Software
ETU	ETSI Termination Unit	SD	Transmit Data
EXT	External	ST	Send Timing
H/W	Hardware	SYNC	Synchronization
HDSL	High-bit-rate Digital Subscriber Line	TM	Test Mode
Hz	Hertz	TT	Terminal Timing
I/F	Interface	UAS	Unavailable Seconds
ID	Identification	UTU	Universal Termination Unit
INT	Internal	V	Volts
kbps	kilobytes per second	Vdc	Volts direct current
km	kilometers	VT100	A terminal-emulation system
LED	Light Emitting Diode	W	Watts

CERTIFICATION AND WARRANTY

DIRECTIVE EN300 386-2 COMPLIANCE

To indicate compliance with EN300 386-2, the UTU-702C List 1 ETU-752C List 1 have been affixed with the CE mark.

LIMITED WARRANTY

ADC DSL Systems, Incorporated (“ADC”) warrants that, for a period of sixty (60) months from the date of shipment, the hardware portion of its products will be free of material defects and faulty workmanship under normal use. ADC’s obligation, under this warranty, is limited to replacing or repairing, at ADC’s option, any such hardware product which is returned during the 12-month warranty period per ADC’s instructions and which product is confirmed by ADC not to comply with the foregoing warranty.

ADC warrants that, for a period of 90 days from the date of purchase, the software furnished with its products will operate substantially in accordance with the ADC published specifications and documentation for such software. ADC’s entire liability for software that does not comply with the foregoing warranty and is reported to ADC during the 90-day warranty period is, at ADC’s option, either (a) return of the price paid or (b) repair or replace of the software. ADC also warrants that, for a period of thirty (30) days from the date of purchase, the media on which software is stored will be free from material defects under normal use. ADC will replace defective media at no charge if it is returned to ADC during the 30-day warranty period along with proof of the date of shipment.

The transportation charges for shipment of returned products to ADC will be prepaid by the Buyer. ADC will pay transportation charges for shipment of replacement products to Buyer, unless no trouble is found (NTF), in which case the Buyer will pay transportation charges.

ADC may use reconditioned parts for such repair or replacement. This warranty *does not* apply to any product which has been repaired, worked upon, or altered by persons not authorized by ADC or in ADC’s sole judgment has subjected to misuse, accident, fire or other casualty, or operation beyond its design range.

Repaired products have a 90-day warranty, or until the end of the original warranty period—whichever period is greater.

ADC DISCLAIMS ALL OTHER WARRANTIES, EITHER EXPRESS OR IMPLIED, INCLUDING BUT NOT LIMITED TO IMPLIED WARRANTIES OF MERCHANTABILITY AND FITNESS FOR A PARTICULAR PURPOSE, WITH RESPECT TO ITS PRODUCTS AND ANY ACCOMPANYING WRITTEN MATERIALS. FURTHER, ADC DOES NOT WARRANT THAT SOFTWARE WILL BE FREE FROM BUGS OR THAT ITS USE WILL BE UNINTERRUPTED OR REGARDING THE USE, OR THE RESULTS OF THE USE, OF THE SOFTWARE IN TERMS OF CORRECTNESS, ACCURACY, RELIABILITY OR OTHERWISE.

MODIFICATIONS

Any changes or modifications made to these devices that are not expressly approved by ADC DSL Systems, Inc. voids the user’s warranty.

All wiring external to the products should follow local wiring codes.

For technical assistance, refer to “Product Support” on page 20.

ADC DSL Systems, Inc.

14402 Franklin Avenue
Tustin, CA 92780-7013

Tel: 714.832.9922

Fax: 714.832.9924

Technical Assistance

Tel: 800.638.0031

Tel: 714.730.3222

Fax: 714.730.2400



DOCUMENT: 700-702-100-02



1244667