

PG-PLUS

TECHNICAL PRACTICE

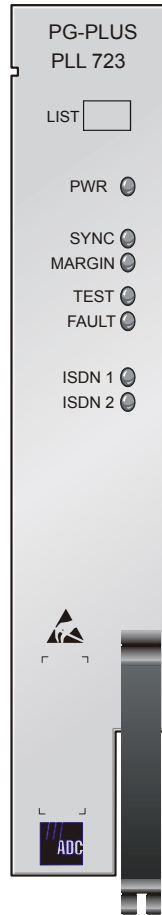

ISDN CENTRAL OFFICE LINE UNIT

Model	List	CLEI Code
PLL-723	1	S9L1AD0A~~

Revision History of This Practice

Revision	Release Date	Revisions Made
01	August 27, 1997	Initial Release
02	February 26, 1999	Specification table corrected and metric conversions added
03	January 25, 2002	Release to rebrand document to comply with ADC standards
04	January 6, 2003	Updated Product Support Information

©Copyright 2003 ADC DSL Systems, Inc. All Rights Reserved.

ADC is a registered trademark of ADC Telecommunications, Inc. PG-Plus is a registered trademark of ADC DSL Systems, Inc. No right, license, or interest to such trademarks is granted hereunder, and you agree that you shall assert no such right, license, or interest with respect to such trademarks. Other product names mentioned in this document are used for identification purposes only and may be trademarks or registered trademarks of their respective companies.

Information contained in this document is company private to ADC DSL Systems, Inc., and shall not be modified, used, copied, reproduced or disclosed in whole or in part without the written consent of ADC.

Contents herein are current as of the date of publication. ADC reserves the right to change specifications at any time without notice. Information furnished by ADC is believed to be accurate and reliable. In no event shall ADC be liable for any damages resulting from the loss of data, loss of use, or loss of profits and ADC further disclaims any and all liability for indirect, incidental, special, consequential or other similar damages. This disclaimer of liability applies to all products, publications and services during and after the warranty period.

USING THIS PRACTICE

Three types of messages, identified by icons, appear in the text.



Notes indicate information about special circumstances.



Cautions indicate the possibility of equipment damage or the possibility of personal injury.



Electrostatic Discharge (ESD) susceptibility symbols indicate that a device or assembly is susceptible to damage from electrostatic discharge. You must wear an antistatic wrist strap connected to the appropriate ground connection prior to performing installation procedures. You must also observe normal ESD precautions when handling electronic equipment. Do not hold electronic plugs by their edges. Do not touch components or circuitry.

INSPECTING YOUR SHIPMENT

Upon receipt of the equipment:

- Unpack each container and visually inspect the contents for signs of damage. If the equipment has been damaged in transit, immediately report the extent of damage to the transportation company and to ADC. Order replacement equipment, if necessary.
- Check the packing list to ensure complete and accurate shipment of each listed item. If the shipment is short or irregular, contact ADC as described in [“Returns” on page 41](#). If you must store the equipment for a prolonged period, store the equipment in its original container.

TABLE OF CONTENTS

Overview	1
Description and Features.....	1
Specifications.....	2
Power Consumption and Heat Dissipation	3
Maximum Heat Dissipation.....	3
Thermal Loading Limitations.....	4
Maximum Power Consumption.....	4
Maximum Current Drain	4
Monitoring, History and Diagnostics.....	4
Performance Parameters	4
Alarms Names and Types.....	5
History	5
LED Descriptions.....	6
Installation and Test	8
Required Tools and Test Equipment.....	8
Installing the COLU.....	8
Initialization Sequence.....	8
Subscriber Drop Tests.....	9
Administration	9
Conventions Used in This Document	9
Logging On	10
Logging Off.....	10
PAU or PMU Main Submenu.....	10
COLU Main Menu.....	12
Navigational Methods.....	13
Menu Bar Selections.....	13
COLU Summary Screen.....	14
Performance Submenu	15
HDSL Summary Screen	16
HDSL 24-Hour History Screen	17
HDSL 7-day History Screen.....	18
ISDN Summary Screen	19
ISDN 7-Hour History Screen	20
Alarms Submenu.....	21
HDSL History Screen.....	22
ISDNn History Screen.....	23

Configuration Submenu.....	24
System Options Screen	25
System Alarm Types Screen	26
HDSL Alarm Thresholds Screen	27
HDSL Alarm Types Screen	28
ISDN Options Screen.....	30
ISDN Alarm Thresholds Screen	31
ISDN Alarm Types Screen	32
Save Configuration Screen.....	33
Set Factory Defaults Screen	34
Test Submenu	35
Information Submenu	37
Inventory Screen	37
Help Screen	38
Fault Isolation	39
COLU and RT Fault Indicators	39
Product Support	41
Technical Support.....	41
Limited Warranty	41
Returns.....	41
FCC Class A Compliance.....	43
Modifications.....	43
Acronyms	44

LIST OF FIGURES

1. Typical System Application	1
2. COLU Front Panel LEDs	6

LIST OF TABLES

1. Power Consumption and Heat Dissipation.....	3
2. Front Panel LED Descriptions.....	7
3. Menu Bar Selections.....	13
4. System Status.....	14
5. HDSL Alarms Screen.....	22
6. System Options Configuration Fields	25
7. System Alarms.....	26
8. HDSL Alarm Thresholds.....	27
9. Alarm Reports	28
10. HDSL Alarms.....	29
11. ISDN Alarms	33

OVERVIEW

This practice describes the PG-Plus® PLL-723 List 1, PAU-710 List 4B, a COLU that provides interfaces for two ISDN subscribers.

DESCRIPTION AND FEATURES

A PG-Plus application, consisting of one COTS, one COLU and one RT, (see [Figure 1](#)) provides bidirectional transport of multiple DS0 over a single, unconditioned wire pair using HDSL technology. Using existing cable, PG-Plus provides for higher bandwidth needs of residential and business customers by providing three POTS and an ISDN interface on a single HDSL twisted-pair wire.

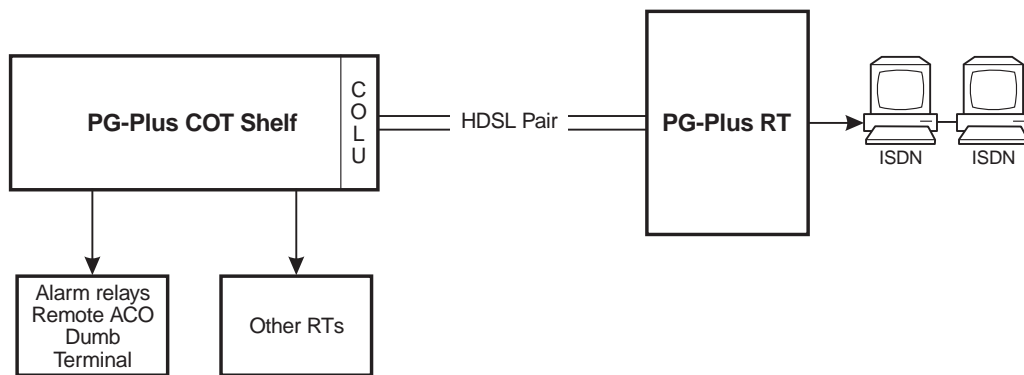

Figure 1. Typical System Application

The COLU provides two ISDN interface over a single twisted pair wire. The COLU uses the ADC HDSL technology to provide the equivalent of 392 Kbps digital transmission rate without the need for repeaters, loop conditioning, or pair selection. The COLU provides a solution to ISDN deployment over a limited cable plant. The COLU can be installed in either the PCS-718 19-inch or the PCS-719 23-inch COTS. The COLU operates in standalone mode with no other COTS circuit cards required. Line power is provided to the RT by the COLU. The COLU performs the interface functions between the ISDN circuits of the CO switching system and the internal digital PCM bus. The COLU maps two ISDN lines onto six DS0 for transmission to the RT on the HDSL pair. To obtain maximum reach, the HDSL line to the RT is operated at the minimum rate to support the payload.

The COLU LEDs provide status of the unit and aid in monitoring the COLU performance. The COLU provides status indicators for power, synchronization, HDSL margin, test condition, fault-presence, and the status of the ISDN lines.

SPECIFICATIONS

Power Supply

Voltage Safety	A2 compliant per GR-1089-CORE
Input Voltage	-42 Vdc to -56 Vdc

HDSL Line

Output Voltage	± 140 Vdc maximum
Output Power	27 Watts maximum
HDSL Line Code	2B1Q
HDSL Line Rate	196 K symbols/sec; 392 K bps
HDSL Reach	12.5 kft (3.81 km), 26 AWG; 18.0 kft (5.48 km), 24 AWG; 25.2 kft (7.68 km), 22 AWG; 37.8 kft (11.5 km) 19 AWG
Maximum Attenuation	41.6 dB at 98 kHz

ISDN U Interface

Input Impedance	135 Ω
Resistive Signature	Tip to Ground 162 K; Ring to Ground 453 K; Tip to Ring 120 K
Performance Monitoring	Interim Path Performance
Provisional Sealing Current	9 mA minimum at RT
Provisional EOC	MP EOC, transparent

Environment

Operating Temperature	-40° F to +150° F; -40° C to +65° C
Operating Humidity	5 percent to 95 percent noncondensing
Altitude	-200 ft. to 13,000 ft.; -60 m to 4,000 m
Vibration	NEBS
ESD	Per GR-1089-CORE
Power and Lightning	Per GR-1089-CORE
Human Safety	UL 1950 for Restricted Access
Emissions Radiation and Immunity	Per GR-1089-CORE for class A equipment

Connector 50 gold-plated card edge fingers

Dimensions

Height	5.5 in. (14.0 cm.)
Width	1.1 in. (2.8 cm.)
Depth	10.25 in. (26.0 cm.)
Weight	1.0 lbs. (0.5 kg.)

POWER CONSUMPTION AND HEAT DISSIPATION

The three most important power demands of a COLU on the COTS power supply are its maximum power consumption, heat dissipation, and current drain. [Table 1](#) lists the power consumption and heat dissipation for the COLU, on a per slot and per COTS basis.



The worst case conditions under which these parameters are measured include a 12,500 ft., 26 AWG loop, a fully loaded COTS, and a -42.5 Vdc COTS battery voltage. The RT is assumed to be ringing one line with a combined load of 5 REN, with one line off hook on each RT. Loop current sink at the COTS is assumed to be 23 mA. Higher loop current feed than 23 mA restricts the number of COTS in a bay due to heating.

Table 1. Power Consumption and Heat Dissipation

Power	COLU Slot	COTS	
		19-inch	23-inch
Maximum Heat Dissipation			
HDSL Line Power Off	2.8 W	33.6 W	44.8 W
HDSL Line Power On	3.4 W	40.8 W	54.4 W
Maximum Power Consumption			
HDSL Line Power Off	2.8 W	33.6 W	44.8 W
HDSL Line Power On	8.43 W	101.1 W	134.8 W
Maximum Current Drain			
HDSL Line Power Off	0.06 A	0.791 A	1.054 A
HDSL Line Power On	0.198 A	2.380 A	3.174 A

Maximum Heat Dissipation

The maximum heat dissipation measures the power that is converted into heat built up within the unit. It contributes to the total heat generated in the space around the unit. This measurement is used to determine the maximum number of fully loaded COTS per bay so as not to exceed the maximum allowable power dissipation density in Watts per square foot.

In CO locations, the maximum heat dissipation for open faced, natural convection-cooled mountings is limited to 134.7 W per square foot as per Section 4.1.4 of the NEBS standard GR-63-CORE. The footprint of a standard 16 slot, 23-inch COTS is 7.042 square foot. The maximum bay dissipation is therefore limited to 948.6 W. At 54.4 W per COTS, this limits the number of fully loaded COTS to seventeen per bay with a heat baffle.

ADC recommends that the number of COTS per bay be limited to six, to allow the flexibility to deploy the widest range of PG-Plus services from each COTS.



This is a worst case situation in that it assumes the entire CO is subjected to the maximum power density. Conditions other than the worst case ones presented in this practice would permit increasing the number of COTS per bay without jeopardizing the CO thermal integrity. Consider also that, due to the chimney effect, it is recommended to install one heat-dissipating baffle between every COTS. Otherwise, the rated operating temperature of the COLU units may be exceeded.

Thermal Loading Limitations

The thermal loading limitations imposed when using the COLU in a CEV or other enclosures are determined by applying the COLU power parameters to the manufacturer's requirements for each specific housing.

Maximum Power Consumption

Maximum power consumption is the total power that the COLU consumes or draws from its -48 Vdc COTS power source. This parameter is needed when the COLU is located remotely from its serving CO. It determines the battery capacity required to maintain an eight-hour standby battery reserve for emergency situations. This limits the maximum number of line units in a remote enclosure.

Maximum Current Drain

Maximum current drain is the maximum current drawn from the COTS power supply when it is at its minimum voltage (-42.5 Vdc). This determines the COTS fusing requirements.

MONITORING, HISTORY AND DIAGNOSTICS

COLUs provide extensive real-time, non-disruptive monitoring of HDSL transmission performance parameters for all units in a circuit. PG-Plus allows user-selectable threshold settings for performance monitoring measurements. This allows alarms to be activated at the designated threshold setting. Performance of the user interface ports is also monitored. Monitored parameters include the following:

- HDSL Noise margin, pulse attenuation, ES, UAS
- Interface ES, SES, UAS, BPV seconds
- Major Alarm Relay Form-C relay contacts (NO, NC, C). Fail-safe operation
- Loopbacks Local interface loopback, local HDSL loopback, remote loopback
- Test Jacks Bridge jack on the front panel

Performance Parameters

Based on the monitored parameters, the COLUs derive the following performance parameters:

- HDSL MAR - A measure of the ratio of signal power to noise power, in dB, at a receiver point. A value of 0 dB means the predicted transmission BER is equal to 10^{-7} , a value of 6 dB means the predicted transmission BER is equal to 10^{-10} . The Main menu status display of the console continuously updates the margin value.
HDSL CRC-6: A 6-bit word in every HDSL frame, representing a calculation based on all the bits in that frame. Any mismatch at the receiver, between the received CRC-6 and the one calculated, based on the received data in the frame, indicates that one or more bits were received in error. The units use this parameter to derive the HDSL ES performance parameter.
- LOSW - The COLU has detected an error in one or more bits in six consecutive HDSL SYNC words. Two consecutive SYNC words must be received without error to clear this condition. A LOSW condition generally indicates the loop is down, thus data cannot be transmitted. The COLU use this parameter to derive UAS performance parameter.
- HDSL ES - An interval of 1 second during which at least one error is detected at the incoming HDSL port or there is an LOSW condition.
- HDSL UAS - An interval of 1 second during which a loop is down.

Alarms Names and Types

The COLUs generate alarms for problem conditions on the HDSL transmission facility and at the application interface. From the [“System Alarm Types Screen”](#) on page 26, you can set the alarms to the value types of Critical, Major, Minor, Not Alarmed, and Not Reported. You can view the alarm status from the [“COLU Summary Screen”](#) on page 14.

- MAR
- ES
- LOSW
- PFO
- PFS
- PGF
- MISMATCH
- NORLUSW
- MISPWRA
- MISPWRB

History

Current cumulative counts of the past twenty-four hours and historical data in the form of 24-hour history and a 7-day history are available to assist in identifying problem sources. You can view the HDSL history from the [“History”](#) on page 5.

LED DESCRIPTIONS

Table 2, in which n equals the POTS line, describes the COLU front-panel LEDs depicted in Figure 2. For further details on the LEDs activities, refer to “Initialization Sequence” on page 8 and the “COLU and RT Fault Indicators” on page 39.

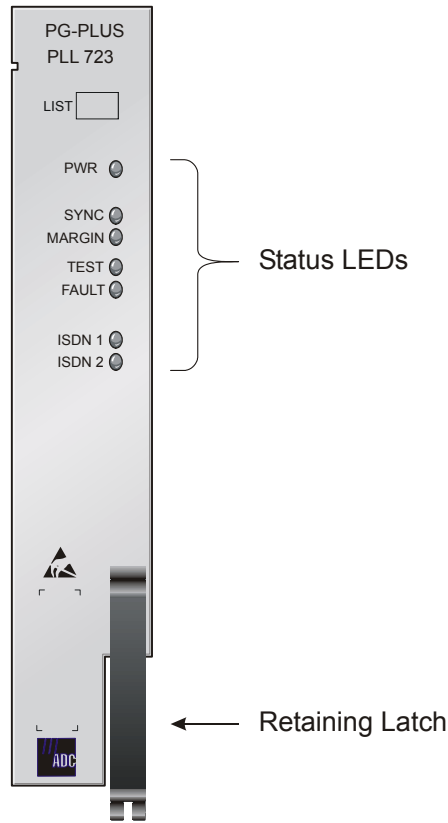

Figure 2. COLU Front Panel LEDs

Table 2. *Front Panel LED Descriptions*

LEDs	Condition	Mode
PWR	On	COLU is powered and the dc power provided to the HDSL pair is normal
	Flashing	One battery feed is missing or a battery feed fuse on the COLU is blown
	and FAULT Flashing	The dc power provided to the HDSL pair is out of normal range
	On, all others flashing at 1 Hz	Running in Boot Mode due to invalid Application Program
	On, all ISDN LEDS On, all others running downward at 1 Hz	Active software download of the COLU
	On, all ISDN LEDS On, all others running upward at 1 Hz	Active software download of the RT connected to the COLU
SYNC	On	HDSL is in synchronization between COLU and RT
	Flashing	COLU and RT are attempting to synchronize
MARGIN	On	COLU HDSL margin is equal to or below the threshold value.
	Flashing	RT HDSL margin is equal to or below the threshold value.
TEST	and ISDN n Flashing	SDT is occurring on ISDN n or loopback is active on ISDN n .
FAULT	On	COLU has a fault.
	Flashing	Alarm condition exists on the COLU.
ISDN n	On	Channel is active and ready for layer 2 communication.

INSTALLATION AND TEST

REQUIRED TOOLS AND TEST EQUIPMENT

No tools are required to install the COLU. For testing, the following tools may be utilized:

- ISDN Basic Rate test set
- Optional, PSU-795, COTS Continuity Test Card, 150-1695-01 List 1

INSTALLING THE COLU

You can install the COLU in any slot except the three positions labeled COMMON, MUX 1, and MUX 2. Refer to the cabling tables provided in the COTS documentation for slot and Telco cabling assignment.

- 1 Open the retaining latch on the front of the COLU.
- 2 Insert the COLU into the card guides in a vacant slot in the COTS that corresponds to the location of the wiring from the CO switch.
- 3 Engage the retaining latch to hold the card in place.

All alarms in the PG-Plus application are suppressed when initially installed and powered up. Any alarms that are generated during this process are Suppressed. When the HDSL is synchronized and the COLU and RT margin has cleared; outstanding Suppressed alarms are made Active and reported to the PAU or the PMU, based upon their provisioned types.

INITIALIZATION SEQUENCE

When the COLU is correctly seated in the COTS, the following events occur in the order listed below:

- All LEDs briefly blink On and then Off, with the exception of the PWR and FAULT LEDs that remain Flashing.
- After about 5 seconds, the COLU applies power and goes into Start-Up mode. If an RT is present and no PFSs or PFOs are detected, the PWR LED is On green and the SYNC LED starts Flashing. If the line is Offhook, the HDSL power is not applied until it goes Onhook for at least 4 seconds. There is a 5 second delay before turning on the HDSL power.
- After applying the HDSL power, the tests for overload or underload conditions are performed. If the HDSL line power is normal, the PWR LED is On and HDSL start-up is initiated.
- As the COLU continues with Start-Up, the SYNC LED Flashes, indicating the HDSL line is attempting to acquire synchronization. When synchronization is complete, the SYNC LED is On. It takes approximately 10 to 15 seconds from the system power-up until the HDSL power is normal. If the first HDSL synchronization attempt fails, the system is powered down and put into the Metallic Fallback state. After a 5 minute period, HDSL power is applied again and a second attempt is made to acquire HDSL synchronization. If the second attempt fails, the system goes into Metallic Fallback state.
- The MARGIN LED is On yellow indicating the COLU signal-to-noise ratio is equal or below the selected signal-to-noise ratio threshold on the COLU. The MARGIN LED Flashes if the signal-to-noise ratio of the HDSL line is equal or below the selected signal-to-noise ratio threshold on the RT.

SUBSCRIBER DROP TESTS

You can perform this function in one of two ways:

- Initiate a SDT by applying a test voltage on the Tip at the COLU through an MLT set
- With the VT-100 Terminal connected to the PAU or PMU maintenance port, select the *Subscriber Drop Test* feature from the Test menu. Relays on the RT provide a path for performing a SDT. The results are reported to the PAU or the PMU and presented as TA-909 resistive signatures.

ADMINISTRATION

Performance monitoring is built into PG-Plus applications. You can access the VT-100 port of the PAU or the PMU to review performance measurements that provide an indication of the quality of transmission to the subscriber. You can perform system administration functions, such as alarm checking and clearing, configuration changes, performance monitoring, and testing for the COLU through the COLU screens.

Connect a VT-100 terminal to the RS-232 interface on the front panel of either the PAU or the PMU to access the COLU screens. If the system does not respond, verify the following values are present:

- VT-100 terminal Hardware Flow Control is set to On
- XON/XOFF is enabled
- ASYNC parameters: Data = 8, Parity = None, Start/Stop = 1.

For further information on connecting a terminal and accessing the screens refer to the PAU or the PMU Technical Practice.



The factory defaults given in this document are standard factory defaults. You may have a customized version of the product, in which case, refer to the PG-Plus Customized Factory Defaults for the values appropriate to the product version you have.

CONVENTIONS USED IN THIS DOCUMENT

Some screen shots in this document come from a prototype setup and may appear slightly different from what you see on your Craft interface screen. The basic information and contents should be similar. This document uses the following conventions for menus and shortcuts:

Example	Describes
<i>menu</i>	name of menu item
<i>submenu</i>	name of submenu item
prompts	the place where you answer yes or no or type some other response
error	the name of what's wrong
error text	an explanation of what's wrong
<i>nnnn</i>	a variable, such as POTS unit 1 in a 6 POTS unit

LOGGING ON

- 1 Press the **SPACEBAR** several times to activate the Autobaud feature. Supported baud rates are 1200, 2400, 4800, 9600, and 38400. The Logon Password screen displays.

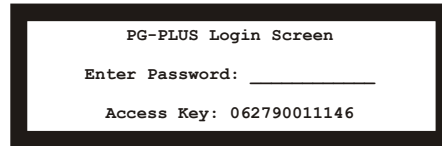

- 2 Type the default password and press **ENTER** to view the PAU or PMU Main menu bar.



The factory-default password is `password#1`. If you establish a different password, you must type the new password at a subsequent log on. Passwords are not case sensitive. The password must use at least 6 and no more than 10 characters, and the new password **MUST** contain at least 1 alpha, 1 numeric, and 1 special character. If the system does not respond, verify that the Hardware Flow Control of the VT-100 terminal is set to **On**.

LOGGING OFF

If you must leave your VT-100 terminal unattended, it is good practice to log out until you are ready to resume work. This prevents unauthorized persons from inadvertently changing any of your operating parameters. Log out by choosing *Logout* from the PAU/PMU Main menu bar or by disconnecting the cable connecting the console to the PAU/PMU.

PAU OR PMU MAIN SUBMENU

The first screen displays the COTS Main menu bar. The screens are identified by the COTS slot number at the top of each screen. The provisionable System ID string displays at the bottom center, the date displays at the lower left of the screen, and the time in military format displays at the lower right of the screen.

Screen Identification and Slot Number

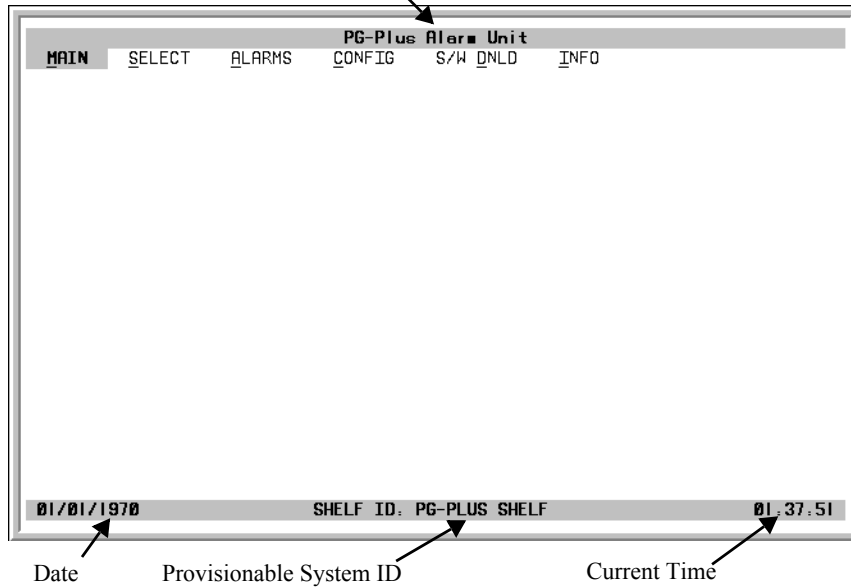

- 1 To access the PAU-710 when you do not know the PAU/PMU slot number, press **ENTER** to view the COTS summary screen. Note the slot number of the desired COLU. There may be more than one of the COLU type you are installing.

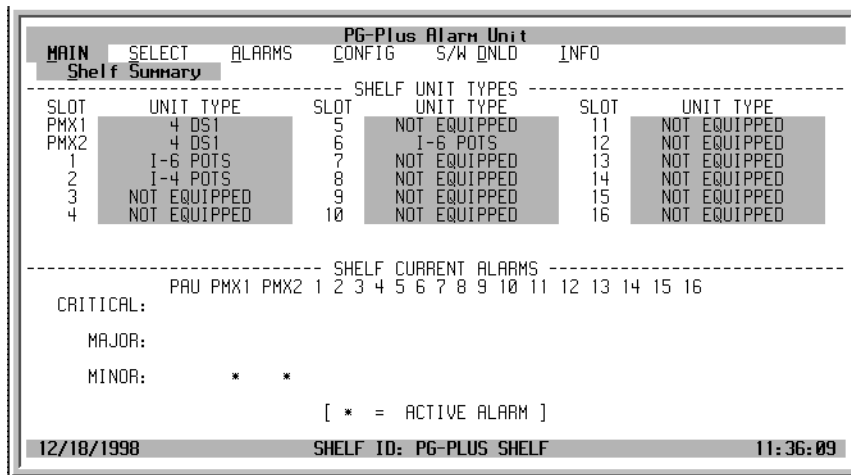

- 2 Press **ESC** to return to the PAU/PMU Main menu bar.

- 3 Scroll to the *Select* option and press **ENTER** to access the submenu.
- 4 Scroll to the desired COLU slot number noted above and press **ENTER**.

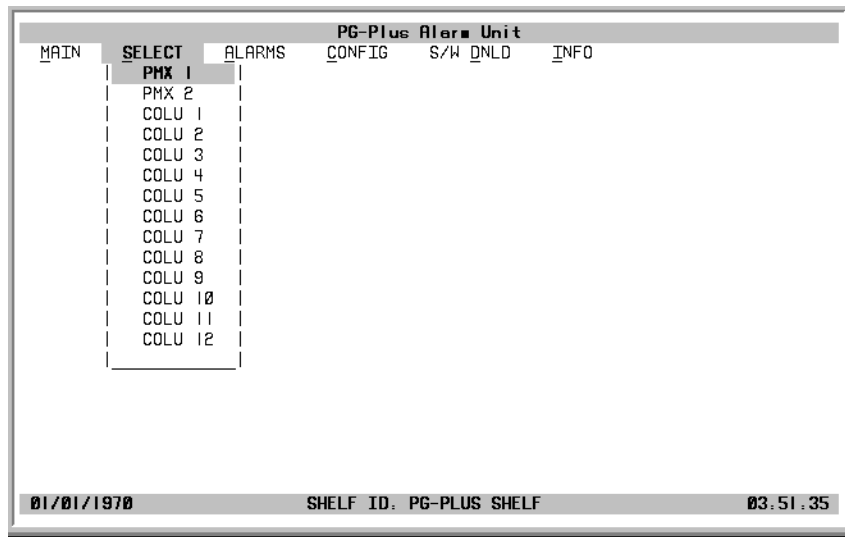

COLU MAIN MENU

When you select the COLU from the PAU or PMU *Select* option, the COLU Main menu displays. You can perform any of the functions listed in [Table 3](#) from this screen.

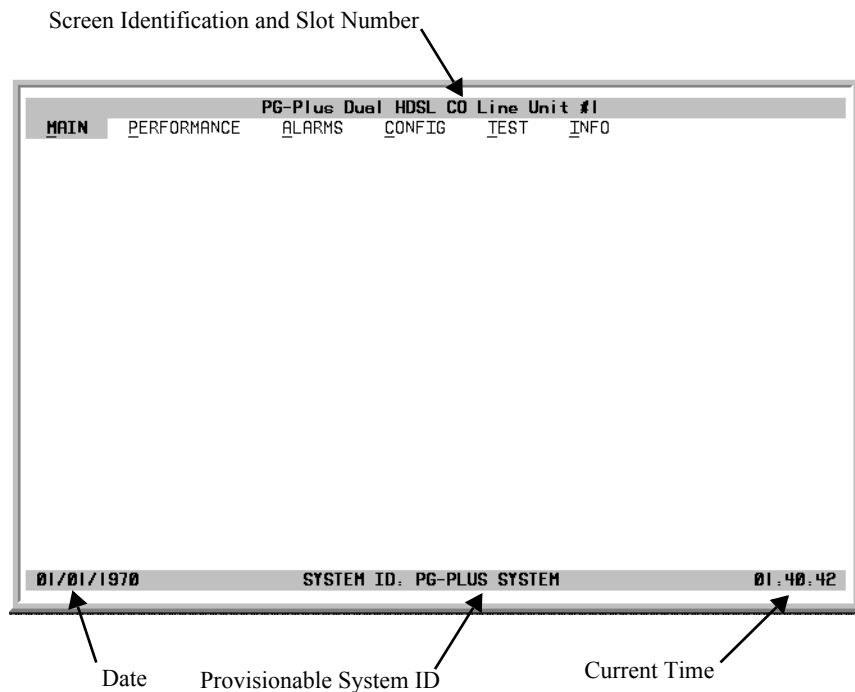

Navigational Methods

The following keyboard keys are your means to navigate through the menus and screens:

A - Z keys	Selects and executes an underlined or highlighted menu item.
←	Moves left across main menu. Moves the cursor to the left.
→	Moves right across main menu. Moves the cursor to the right.
↑	Moves up the submenu selection. Moves the cursor up the screen items.
↓	Moves down the submenu selection. Moves the cursor down the screen items.
CTRL + R	Returns to the PAU or PMU Main screen. The ADC banner appears briefly and then the Main menu bar displays.
SPACEBAR	No effect. At COLU screen cycles through choices.
ESC	Exits the current screen and returns to the previous screen. Selection changes made on the current screen are discarded. Press ESC in a text field to cancel the text entry and restore the old value.
ENTER	Moves to submenu or screen selected. At the screen, it submits all selection changes on the current screen and makes them effective in the system.

Menu Bar Selections

Table 3 describes the menus and submenus selectable from the COLU menu bar.

Table 3. Menu Bar Selections

Select the underlined alpha character:	To:
<u>M</u>ain	View the circuit configuration. View performance summary information. View alarm summary information.
<u>P</u>erformance	View HDSL Summary and reset the minimum and maximum margin counts. View date and time of the last reset of the minimum and maximum margin counts. View information about the HDSL span, 24-hours of performance history including ES, UAS and validity of counts. Clear the history screens. View 7-day history plus current day's accumulated performance information including ES, UAS and validity of counts.
<u>A</u>larms	View the HDSL History screen detailing, number of times each alarm occurred, time and date of first and last occurrence, provisioned notification type, and current status. Clear the alarm history
<u>C</u>onfig	View or change options such as SDT, HDSL Periodic Power Up, and System ID. View or change alarm types of all System alarms View or change threshold crossing values for the 24-hour ES count and low margin dB. View or change the HDSL and DSL line power alarms. Set all operating parameters to factory defaults.
<u>T</u>est	Test subscriber drop by either of two methods. View results that include hazardous voltages, foreign voltages, resistive faults, and CPE termination status.
<u>I</u>nf	Summary of navigational methods Display registration information to track product manufacturing, configuration, and revision state.

COLU Summary Screen

This screen details the performance condition of the COLU and RT.

- 1 Select *Main* from the menu bar and press **ENTER** to view this screen.



- 2 Press **ESC** to move up a menu level, or **CTRL + R** to return to the PAU/PMU Main menu. Refer to the Performance and Alarms screens for a detailed description of data displayed in these areas.

Table 4. System Status

System Status	Description
HDSL Line Status	
Restart Pending	HDSL link is down and pending restart.
Start-up	System in start-up mode where the HDSL link is acquiring synchronization.
Normal	System running normal where the HDSL link is synchronized and speech and signaling data are flowing between the COLU and the RT.
ISDN Channels Status	
Active	The act bit in the ISDN M-channel is set in the customer direction (towards NT1) as well as network direction (towards LT)
Not Active	The act bit in the ISDN M-channel is reset in the customer direction or network direction or both.

PERFORMANCE SUBMENU

The Performance submenu provides access to the COLU performance screens. Select *Performance* at the menu bar and press **ENTER** to display the submenu.

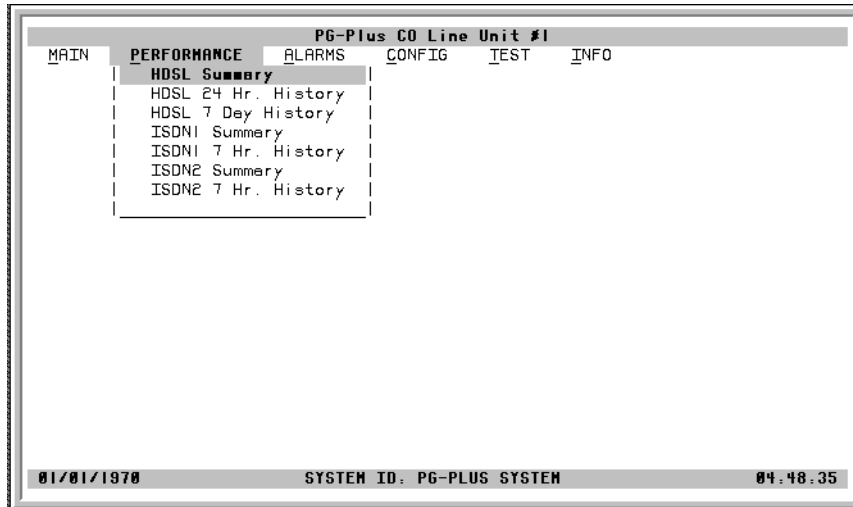

HDSL Summary Screen

This screen depicts an HDSL performance summary in terms of the margin and UAS and ES count. Use the available options to reset the minimum and maximum margin counts.

- 1 Select *Performance* at the menu bar and press **ENTER** to display the submenu.
- 2 Scroll to the *HDSL Summary* option and press **ENTER** to view the screen.

PG-Plus POTS CO Line Unit #1					
MAIN	PERFORMANCE	ALARMS	CONFIG	TEST	INFO
HDSL Summary					
				COLU	RLU
	Current Margin (dB)	:		20	21
	Minimum Margin (dB)	:		20	21
	Maximum Margin (dB)	:		21	22
	Errored Seconds (24 Hr.) (ES)	:		0	0
	Unavailable Seconds (24 Hr.) (UAS)	:		0	0
	Insertion Loss (dB)	:		0	0
	HDSL Tip/Ring Reversal (YES/NO)	:		NO	
RESET MIN/MAX MARGIN COUNTS (Y)? <input type="checkbox"/>					
MIN/MAX MARGIN COUNTS LAST RESET: --/--/---- --:--:--					
01/01/1970		SYSTEM ID: PG-PLUS SYSTEM		01:15:26	

The following performance parameters are reported:

- Margins: A measure of the ratio of signal power to noise power, in dB, at a receiver point.
 - Current Margin: The way the line looks now
 - Maximum Margin: The maximum value measured
 - Minimum Margin: The minimum value measured
- ES: An interval of 1 second during which at least 1 error is detected at the incoming HDSL port or there is an LOSW condition.
- UAS: An interval of 1 second during which a loop is down.
- Insertion Loss: dB measurement of signal loss

If your COLU has an earlier software version your screen will display the following two lines instead of the Insertion Loss line:

- Pulse Attenuation: dB measurement of signal loss
- PPM Offset: the measure of the PPM difference between the RT and the COLU
- HDSL Tip and Ring Reversal

- 3 If you want to reset the counts, type **Y** at the Reset MIN/MAX Margin Counts prompt. The current 15-minute interval information shows the real-time updates. The first 15-minute interval is marked 00:00 and represents 12:00-12:15 AM of the current day.



If there are active alarms associated with the current 15-minute and 24-hour performance history information, those alarms become inactive when the 24-hour performance history is cleared. The date and time the 15-minute and 24-hour performance histories were last cleared appears at the bottom of the screen.

HDSL 24-Hour History Screen

This screen shows twenty-four hours of HDSL performance history. The performance history data displayed includes ES counts, UAS counts, and the validity of the counts.

- 1 Select *Performance* at the menu bar and press **ENTER** to display the submenu.
- 2 Scroll to the *HDSL 24 Hr. History* option and press **ENTER** to view the screen:

PG-Plus CO Line Unit #1						
MAIN	PERFORMANCE	ALARMS	CONFIG	TEST	INFO	
HDSL 24 Hr. History						
COLU			RLU			
Hour	ES	UAS	VALIDITY	ES	UAS	VALIDITY
00:00	0	0	ADJUSTED	0	0	ADJUSTED
00:15	0	0	UNAVAILABLE	0	0	UNAVAILABLE
00:30	0	0	UNAVAILABLE	0	0	UNAVAILABLE
00:45	0	0	UNAVAILABLE	0	0	UNAVAILABLE
01:00	0	0	UNAVAILABLE	0	0	UNAVAILABLE
01:15	0	0	UNAVAILABLE	0	0	UNAVAILABLE
01:30	0	0	UNAVAILABLE	0	0	UNAVAILABLE
01:45	0	0	UNAVAILABLE	0	0	UNAVAILABLE
02:00	0	0	UNAVAILABLE	0	0	UNAVAILABLE
02:15	0	0	UNAVAILABLE	0	0	UNAVAILABLE
PAGE HISTORY BACKWARD			PAGE HISTORY FORWARD		CLEAR HISTORY	
HDSL 24 HOUR HISTORY LAST CLEARED: --/--/---- --:--:--						
01/01/1970		SYSTEM ID: PG-PLUS SYSTEM			04:50.33	

The COLU derives the ES and UAS performance parameters with the following field values:

- Unavailable: The system has not run long enough to fill this register.
- Partial: Data is being collected for this register.
- Complete: Data is saved in the history register for the complete interval.
- Adjusted: The time or date has been changed on the system during the interval.

- 3 Highlight either of the paging fields and press **ENTER** to scroll through all ninety-six 15-minute intervals.
- 4 To clear the history, highlight the Clear History field and press **ENTER**. The current 15-minute interval information shows the real-time updates. The first 15-minute interval is marked 00:00 and represents 12:00-12:15 AM of the current day.



If there are active alarms associated with the current 15-minute and 24-hour performance history information, those alarms become inactive when the 24-hour performance history is cleared. The date and time the 15-minute and 24-hour performance history was last cleared appears at the bottom of the screen.

- 5 Press **ESC** to move up a menu level, or **CTRL + R** to return to the PAU/PMU Main menu.

HDSL 7-day History Screen

Shows seven days of performance history plus the current day's accumulated performance information. The information displayed includes ES counts, UAS counts, and the validity of the counts.

- 1 Select *Performance* at the menu bar and press **ENTER** to display the submenu.
- 2 Scroll to the *HDSL 7 Day History* option and press **ENTER** to view the screen:

PG-Plus CO Line Unit #1						
MAIN	PERFORMANCE	ALARMS	CONFIG	TEST	INFO	
HDSL 7 Day History						
COLU			RLU			
Date	ES	UAS	VALIDITY	ES	UAS	VALIDITY
01/01	0	0	ADJUSTED	0	0	ADJUSTED
12/31	0	0	UNAVAILABLE	0	0	UNAVAILABLE
12/30	0	0	UNAVAILABLE	0	0	UNAVAILABLE
12/29	0	0	UNAVAILABLE	0	0	UNAVAILABLE
12/28	0	0	UNAVAILABLE	0	0	UNAVAILABLE
12/27	0	0	UNAVAILABLE	0	0	UNAVAILABLE
12/26	0	0	UNAVAILABLE	0	0	UNAVAILABLE
12/25	0	0	UNAVAILABLE	0	0	UNAVAILABLE

CLEAR HDSL 7 DAY HISTORY (Y)?

HDSL 7 DAY HISTORY LAST CLEARED: --/--/---- --:--:--

01/01/1970 SYSTEM ID: PG-PLUS SYSTEM 04.51.08

The COLU derives the following performance parameters:

- ES: An interval of 1 second during which at least one error is detected at the incoming HDSL port or there is an LOSW condition.
 - UAS: An interval of 1 second during which a loop is down.
 - Validity field values are as follows:
 - Unavailable: The system has not run long enough to fill this register.
 - Partial: Data is being collected for this register.
 - Complete: Data is saved in the history register for the complete interval.
 - Adjusted: The time or date has been changed on the system during the interval.
- 3 To clear the 7-day history information, type **Y** at the Clear HDSL 7 day History prompt. The current day performance information shows real-time updates. At midnight of every day, the current day performance information is moved into the previous day slot and the current day performance information is cleared.



Clearing the 7-day performance history does not clear the current day performance information. The current day performance information may only be cleared through the HDSL 24-hour performance history screen. The date and time that the 7-day performance history was last cleared appears at the bottom of the screen.

- 4 Press **ESC** to move up a menu level, or **CTRL + R** to return to the PAU/PMU Main menu.

ISDN Summary Screen

Shows all of the stored ISDN performance data for the COLU and the RT. The displayed information includes:

- ES and SES counts for the current hour, the previous hour, the current day and the previous day
- BE counts for the current hour and previous hour.

Errors in the Customer column indicate errors in transmission from the Network (ISDN switch) to the Customer. Errors in the Network column indicate errors in transmission from the Customer to the Network (ISDN switch).

- 1 Select *Performance* at the menu bar and press **ENTER** to display the submenu.
- 2 Scroll to the *ISDN Summary* option and press **ENTER** to view the screen:

PG-Plus CO Line Unit #1											
MAIN		PERFORMANCE		ALARMS		CONFIG		TEST		INFO	
ISDN2 Summary											
PM TYPE: Interim Path											
		COLU CURRENT		COLU PREVIOUS		RLU CURRENT		RLU PREVIOUS			
		Customer/Network		Customer/Network		Customer/Network		Customer/Network			
HOURLY ES :		0 /	1	0 /	0	0 /	1	0 /	0		
HOURLY SES :		0 /	1	0 /	0	0 /	1	0 /	0		
HOURLY BE :		0 /	41	0 /	0	0 /	41	0 /	0		
DAILY ES :		0 /	1	0 /	0	0 /	1	0 /	0		
DAILY SES :		0 /	1	0 /	0	0 /	1	0 /	0		
CLEAR ISDN2 CURRENT COUNTS (Y)? █											
ISDN2 CURRENT COUNTS LAST CLEARED: --/--/---- --:--:--											
01/01/1970				SYSTEM ID: PG-PLUS SYSTEM				04.52.00			

- 3 At the prompt, type **Y** to clear the information, or **N** to leave the data as is. You have the option to reset all the information displayed to zero. The date and time the ISDN information was last cleared is displayed at the screen bottom. The PM counts are updated every fifteen seconds.



Clearing the current ISDN performance data clears the performance counts for the COLU and the RLU. If there are alarms associated with the performance counts at the COLU and RT, those alarms are reset when the ISDN performance data is cleared.

- 4 Press **ESC** to move up a menu level, or **CTRL + R** to return to the PAU/PMU Main menu.

ISDN 7-Hour History Screen

Displays the 7-hour ISDN ES history information for the COLU and the RT. The ES counts for the current hour and the previous hour are also displayed for completeness. This means that the 7-hour history begins with the hour prior to the previous hour. The PM counts are updated every 15 seconds.

- 1 Select *Performance* at the menu bar and press **ENTER** to display the submenu.
- 2 Scroll to the *ISDN 7-Hr. History* option and press **ENTER** to view the screen:

PG-Plus CO Line Unit #1					
MAIN	PERFORMANCE	ALARMS	CONFIG	TEST	INFO
ISDN2 7 Hr. History					
ISDN2 Hourly ES History					
	COLU		RLU		
	Customer	Network	Customer	Network	
Current Hour :	0 /	1	0 /	1	
Previous Hour :	0 /	0	0 /	0	
Previous Hour-1 :	0 /	0	0 /	0	
Previous Hour-2 :	0 /	0	0 /	0	
Previous Hour-3 :	0 /	0	0 /	0	
Previous Hour-4 :	0 /	0	0 /	0	
Previous Hour-5 :	0 /	0	0 /	0	
Previous Hour-6 :	0 /	0	0 /	0	
Previous Hour-7 :	0 /	0	0 /	0	

01/01/1970 SYSTEM ID: PG-PLUS SYSTEM 04.52.57

Errors appearing in the Customer column indicate errors in transmission from the Network (ISDN switch) to the Customer. Errors in the Network column indicate errors in transmission from the Customer to the Network (ISDN switch).

- 3 Press **ESC** to move up a menu level, or **CTRL+R** to return to the PAU/PMU Main menu.

ALARMS SUBMENU

The COLU detects and reports HDSL, POTS, and System related alarmed events to the PAU/PMU (if present). Only events provisioned for Major or Minor notification types are reported. Select *Alarms* at the menu bar and press **ENTER** to view the submenu.

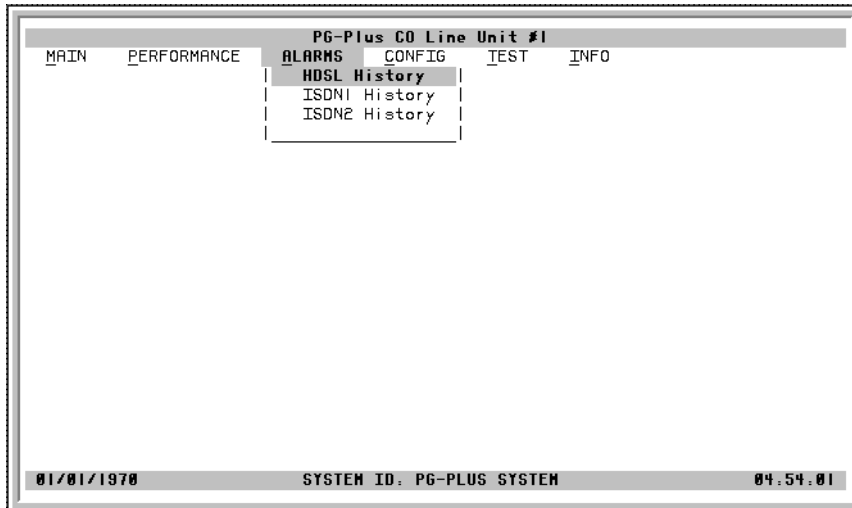

HDSL History Screen

The HDSL history maintained on the COLU contains a count of the number of times each alarm occurred, the time and date of the first and last occurrence, the provisioned notification type, and the current status (see Table 5). Here you see the results of the alarms set at the Configuration “HDSL Alarm Types Screen” on page 28.

- 1 Select *Performance* at the menu bar and press **ENTER** to display the submenu.
- 2 Scroll to the *HDSL History* option and press **ENTER** to view the screen:

PG-Plus CO Line Unit #1						
MAIN	PERFORMANCE	ALARMS	CONFIG	TEST	INFO	
HDSL History						
COLU ALARMS	TYPE	CURRENT	COUNT	FIRST	LAST	
HDSL LOSW	MN	OK	1	01/01 04:44	01/01 04:44	
HDSL ES THRESH	MN	OK	0	--/-- --:--	--/-- --:--	
HDSL LOW MARGIN	MN	OK	0	--/-- --:--	--/-- --:--	
POWER FEED OPEN	MN	OK	0	--/-- --:--	--/-- --:--	
POWER FEED SHORT	MN	OK	0	--/-- --:--	--/-- --:--	
RLU ALARMS	TYPE	CURRENT	COUNT	FIRST	LAST	
HDSL LOSW	MN	OK	1	01/01 04:44	01/01 04:44	
HDSL ES THRESH	MN	OK	0	--/-- --:--	--/-- --:--	
HDSL LOW MARGIN	MN	OK	1	01/01 04:44	01/01 04:44	
CLEAR HDSL ALARM HISTORY (Y)? <input type="checkbox"/>						
HDSL ALARM HISTORY LAST CLEARED: --/--/---- --:--:--						
01/01/1970		SYSTEM ID: PG-PLUS SYSTEM			04:54:40	

If there are no active alarms, the status OK appears in the Current column.

- 3 You can clear the alarm history at this screen or when power is removed from the line unit. Type **Y** at the Clear HDSL Alarm History? prompt to clear the information.



If an alarm is not active when you clear the history, the count is reset to 0 and the time stamps for the first and last alarms are cleared.

- 4 Press **ESC** to move up a menu level, or **CTRL + R** to return to the PAU/PMU Main menu.

Table 5. HDSL Alarms Screen

Alarm	Description	Default
LOSW	COLU cannot receive data over the given HDSL loop. COLU and RT cannot synchronize and are out of service.	MN
ES-24 Hr.	Number of HDSL ES exceeded the user-configurable threshold to give advance warning that HDSL performance is deteriorating. Set this threshold from 0-255 ES over a 24-hour period, or disable the alarm completely.	MN
MAR	HDSL noise margin of the loop has fallen below the user-configurable threshold. HDSL margin reaches or drops below the current threshold value.	MN
PFO	COLU cannot power the RT due to an open circuit. An undercurrent condition as detected by the RT exists for the given pair (<20 mA). A possible cause is that there is no RT at the other end of the circuit. No user intervention is required	MN

Table 5. HDSL Alarms Screen

PFS	COLU cannot power the RT due to a short circuit. An excessive current condition as detected by the COLU MN exists for either pair (>50 mA). PFS alarm indicates an overcurrent condition due to wire shorting or an RT failure. COLU automatically turns off power feeding to both loops in response to a PFO or PFS condition on a single loop. No user intervention is required.
-----	--

ISDNn History Screen

The ISDNn History pages include the alarm name, the provisional alarm type, the current status of the alarm, the number of times the alarm was reported, the date and time of the first reported alarm and that of the last reported alarm. Here you see the results of the alarms set at the Configuration “ISDN Alarm Types Screen” on page 32.

- 1 Select *Alarms* at the menu bar and press **ENTER** to display the submenu.
- 2 Scroll to the *ISDNn History* option and press **ENTER** to view the screen:

PG-Plus CO Line Unit #1						
MAIN	PERFORMANCE	ALARMS	CONFIG	TEST	INFO	
ISDN2 History						
COLU ALARMS		TYPE	CURRENT	COUNT	FIRST	LAST
LOSS OF SYNC WORD		NA	OK	0	--/--	--/--
LOSS OF SIGNAL		NA	OK	0	--/--	--/--
ES HOURLY THRESH (CUST)		MN	OK	0	--/--	--/--
ES DAILY THRESH (CUST)		MN	OK	0	--/--	--/--
SES HOURLY THRESH (CUST)		MN	OK	0	--/--	--/--
SES DAILY THRESH (CUST)		MN	OK	0	--/--	--/--
ES HOURLY THRESH (NTWK)		MN	OK	0	--/--	--/--
ES DAILY THRESH (NTWK)		MN	OK	0	--/--	--/--
SES HOURLY THRESH (NTWK)		MN	OK	0	--/--	--/--
SES DAILY THRESH (NTWK)		MN	OK	0	--/--	--/--
DATA TRANSPARENCY LOST		MN	OK	0	--/--	--/--
D+ LOSS OF SYNC WORD		MN	OK	1	01/01 04:44	01/01 04:44
DISPLAY RLU ISDN2 ALARM HISTORY				CLEAR ISDN2 ALARM HISTORY		
ISDN2 ALARM HISTORY LAST CLEARED: --/--/---- --:--:--						
01/01/1970		SYSTEM ID: PG-PLUS SYSTEM			04:56:48	

If there are no active alarms, the status OK appears in the Current column.

- 3 Use the Display RLU ISDNn Alarm History field at the bottom to move to the RT history page.

PG-Plus CO Line Unit #1						
MAIN	PERFORMANCE	ALARMS	CONFIG	TEST	INFO	
ISDN2 History						
RLU ALARMS		TYPE	CURRENT	COUNT	FIRST	LAST
LOSS OF SYNC WORD		NA	OK	0	--/--	--/--
LOSS OF SIGNAL		NA	OK	0	--/--	--/--
ES HOURLY THRESH (CUST)		NA	OK	0	--/--	--/--
ES DAILY THRESH (CUST)		NA	OK	0	--/--	--/--
SES HOURLY THRESH (CUST)		NA	OK	0	--/--	--/--
SES DAILY THRESH (CUST)		NA	OK	0	--/--	--/--
ES HOURLY THRESH (NTWK)		NA	OK	0	--/--	--/--
ES DAILY THRESH (NTWK)		NA	OK	0	--/--	--/--
SES HOURLY THRESH (NTWK)		NA	OK	0	--/--	--/--
SES DAILY THRESH (NTWK)		NA	OK	0	--/--	--/--
DATA TRANSPARENCY LOST		NA	OK	0	--/--	--/--
D+ LOSS OF SYNC WORD		NA	OK	0	--/--	--/--
DISPLAY COLU ISDN2 ALARM HISTORY				CLEAR ISDN2 ALARM HISTORY		
ISDN2 ALARM HISTORY LAST CLEARED: --/--/---- --:--:--						
01/01/1970		SYSTEM ID: PG-PLUS SYSTEM			04:57:28	

- 4 Use the Clear ISDNn Alarm History field at the bottom to clear the history information.



Clearing the alarm history clears the RT and the COLU alarm history, regardless of whether you clear it from the COLU or the RT page of the history screen. If there is an active alarm, then the count will be set to 1 and the value in the Last date and time field will be set to the First date and time field. If an alarm is not active when you clear the history, the count is reset to 0 and the time stamps for the first and last alarms are cleared.

- 5 Press **ESC** to move up a menu level, or **CTRL + R** to return to the PAU/PMU Main menu.

CONFIGURATION SUBMENU

Provides access to system provisioning screens, and an easy means of resetting all options to factory defaults. Select *CONFIG* at the menu bar and press **ENTER** to view the submenu.



System Options Screen

Allows the provisioning of options such as ringing frequency, SDT, HDSL Periodic Power Up, and a System ID. Table 6 shows the configured system data and their factory default value.

- 1 Select *CONFIG* at the menu bar and press **ENTER** to display the submenu.
- 2 Scroll to the *System Options* line and press **ENTER** to view the screen:

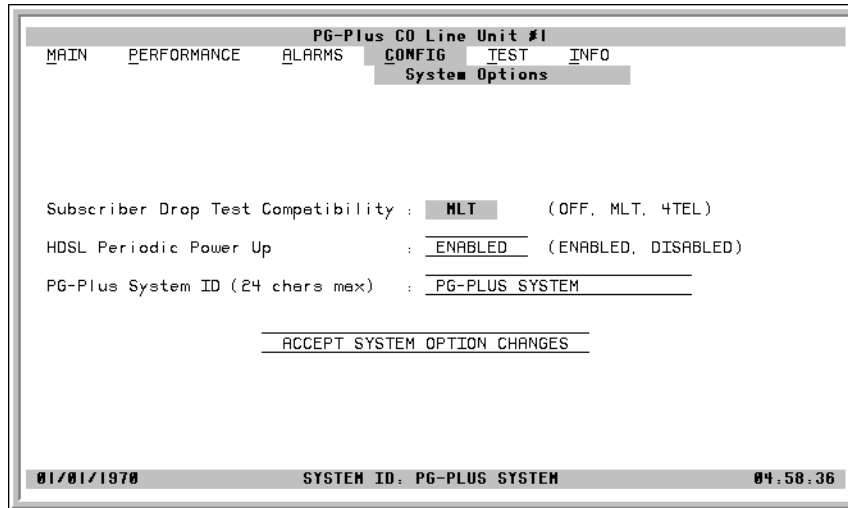

- 3 Highlight the desired field and press the **SPACEBAR** to toggle to the desired value, or move to the next option.
- 4 Move to the Accept System Option Changes field, and press **ENTER** to accept the changes.
- 5 Press **ESC** to move up a menu level, or **CTRL + R** to return to the PAU/PMU Main menu.

Table 6. System Options Configuration Fields

Options	Description	Default
SDT Compatibility	Specifies whether the PG-Plus initiates and operates with MLT or 4TEL loop test systems. Possible values include Off, MLT, and 4TEL. Craft initiated drop tests work in any selection.	Off
HDSL Periodic Power Up	When Enabled, PG-Plus in Metallic Fallback attempts to power up the HDSL line every five minutes or anytime the HDSL pair is shorted for two seconds and then opened. Setting to Disabled inhibits the power up sequence under any circumstances and the system remains in Metallic Fallback.	Enabled
PG-Plus System ID	Configurable identification string for system can be up to 24 characters. Because the System ID is always visible at the bottom of the every COLU screen, it is easy for a user to know which COLU screens are being displayed. There are no special rules for changing the System ID. Any printable character, including space, is valid.	PG-Plus System

System Alarm Types Screen

Allows the provisioning of the alarm types of all system alarms including incompatible COLU and RT. [Table 7](#) shows the System Alarm fields and their default settings. You can view the results of these settings from the “COLU Summary Screen” on page 14.

- 1 Select *CONFIG* at the menu bar and press **ENTER** to display the submenu.
- 2 Scroll to the *System Alarm Types* option and press **ENTER** to view the screen:

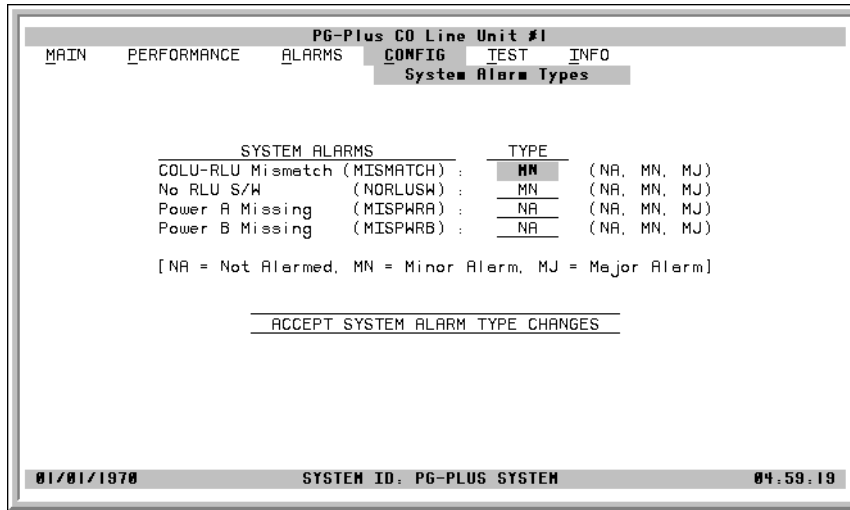

- 3 Highlight the COLU RLU Mismatch option and press the **SPACEBAR** to toggle to the desired value for the Alarm Type.
- 4 Move to the next option. Continue until you have completed your changes.
- 5 Move to the Accept System Alarm Types Changes field, and press **ENTER** to accept the changes.
- 6 Press **ESC** to move up a menu level, or **CTRL + R** to return to the Main menu.

Table 7. System Alarms

Abbreviation	Description	Default
MISPWRA	-48 Vdc A power is missing on the COLU or a fuse is blown.	NA
MISPWRB	-48 Vdc B power is missing on the COLU or a fuse is blown.	NA
MISMATCH	COLU and RT hardware type incompatible.	MN
NORLUSW	RLU has no software; awaiting software download.	MN

HDSL Alarm Thresholds Screen

This screen is a means to provision the threshold crossing values for the 15 minute and 24-hour ES and UAS counts and low margin dB. Table 8 lists the fields of the HDSL Alarm Thresholds and the default factory values.

- 1 Select *CONFIG* at the menu bar and press **ENTER** to display the submenu.
- 2 Scroll to the *HDSL Alarm Thrshlds* option and press **ENTER** to view the screen:

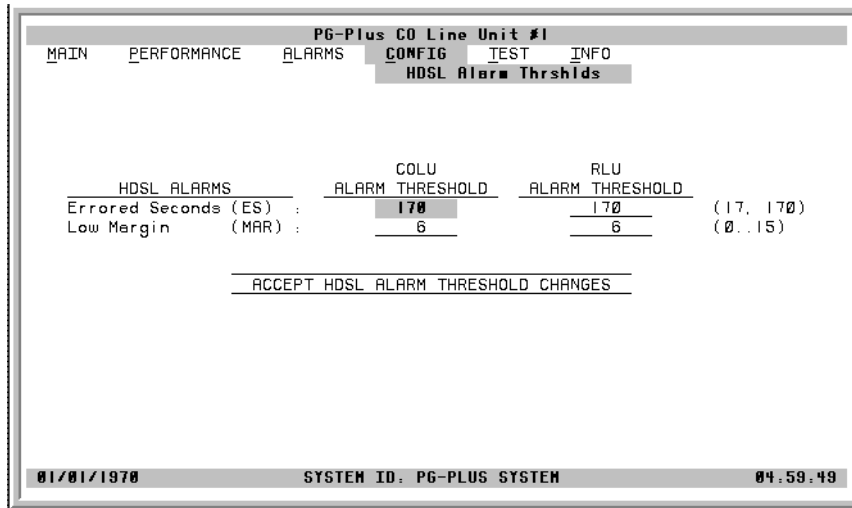

- 3 With the desired field highlighted, press **SPACEBAR** to toggle to the desired value.
- 4 Move to the next option. Continue until you have completed your changes.
- 5 Move to the Accept System Option Changes field and press **ENTER** to accept the changes.
- 6 Press **ESC** to move up a menu level, or **CTRL + R** to return to the PAU/PMU Main menu.

Table 8. HDSL Alarm Thresholds

Thresholds	Description	Default
ES(24 Hr. count)	An HDSL ES alarm is set active if ES counts become equal to or exceeds this threshold. Possible HDSL ES threshold values include 17 and 170.	170
MAR (dB)	An HDSL Low Margin alarm is set active if margin becomes equal to or below this threshold. Possible HDSL low margin threshold values include any values from 0 through 15.	6

HDSL Alarm Types Screen

Allows the provisioning of the alarm types for all HDSL Alarms. [Table 9](#) lists the Alarm Reports and [Table 10](#) shows the HDSL Alarms, the possible alarm Types, and the default factory settings. You can view the results of these settings from the “HDSL History Screen” on page 22.

- 1 Select *CONFIG* at the menu bar and press **ENTER** to display the submenu.
- 2 Scroll to the *HDSL Alarm Types* option and press **ENTER** to view the screen:

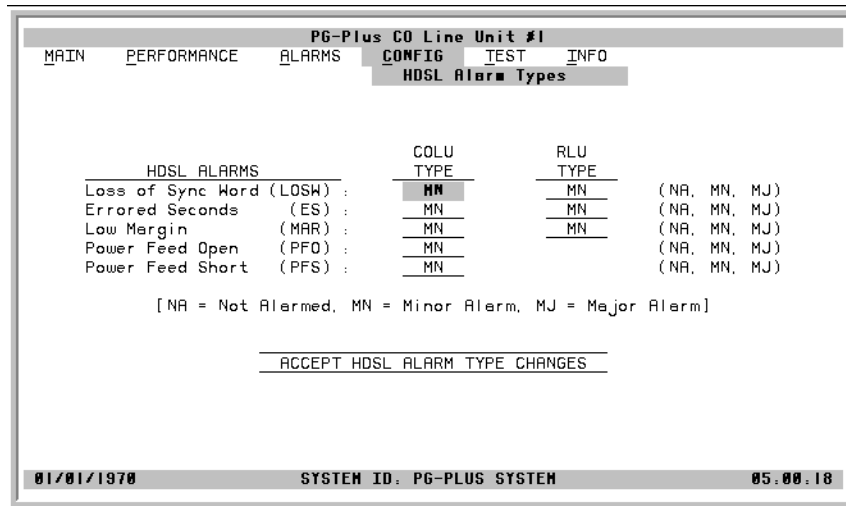

- 3 At the LOSW field in the COLU Alarm Type column, press **TAB** to toggle to the desired value.
- 4 Move to the next option. Continue until you have completed your changes.
- 5 Move to the Accept HDSL Alarm Type Changes field, and press **ENTER** to accept the changes.
- 6 Press **ESC** to move up a menu level, or **CTRL + R** to return to the PAU/PMU Main menu.

Table 9. Alarm Reports

Settings	PAU/PMU Reports	Fault LED Affected	Main Summary Listing	Alarm History Updated
MJ/MN	Yes	Yes	Yes	Yes
NA	No	No	No	No
NR	No	Yes	Yes	Yes

Table 10. HDSL Alarms

Alarm	Description	Default
LOSW	COLU cannot receive data over the given HDSL loop. COLU and RT cannot synchronize and is out of service.	MN
ES-15 Min.	Number of HDSL ES has exceeded the user-configurable threshold to give advance warning that HDSL performance is deteriorating. You can set this threshold from 0-15 ES over a 15-minute period, or disable the alarm completely. 24 hour ES alarm threshold reached or exceeded.	MN
ES-24 Hr.	Number of HDSL ES has exceeded the user-configurable threshold to give advance warning that HDSL performance is deteriorating. You can set this threshold from 0-255 ES over a 24-hour period, or disable the alarm completely. 24 hour ES alarm threshold reached or exceeded.	MN
MAR	HDSL noise margin of the loop has fallen below the user-configurable threshold. HDSL margin reaches or drops below the current threshold value.	MN
PFO	COLU cannot power the RT due to an open circuit. An undercurrent condition as detected by the RT exists for the given pair (<20 mA). A possible cause is that there is no RT at the other end of the circuit. No user intervention is required.	MN
PFS	COLU cannot power the RT due to a short circuit. An excessive current condition as detected by the COLU exists for either pair (>50 mA). A PFS alarm indicates an overcurrent condition due to wire shorting or an RT failure. COLU automatically turns off power feeding to both loops in response to a PFO or PFS condition on a single loop. No user intervention is required.	MN

ISDN Options Screen

Provides access to configure the ISDN parameters. The values on the screen are the factory defaults. The Sealing Current field allows the current to be turned On or Off between the RT and the CPE. The EOC Mode field allows the EOC processing type to be selected. The COLU and RT SES counts are the number of ISDN BE allowed before SES count is incremented.

- 1 Select *CONFIG* at the menu bar and press **ENTER** to display the submenu.
- 2 Scroll to the *ISDNn Options* line and press **ENTER** to view the screen:

```
PG-Plus CO Line Unit #1
MAIN PERFORMANCE ALARMS CONFIG TEST INFO
ISDN1 Options

Sealing Current : ON (ON, OFF)
EOC Mode       : MP-EOC-SLAVE (MP-EOC-SLAVE, TRANSPARENT)
COLU SES Count : 3 (1..15)
RLU SES Count  : 3 (1..15)

ACCEPT ISDN1 OPTION CHANGES

01/01/1970 SYSTEM ID: PG-PLUS SYSTEM 05:00:56
```

- 3 At the Sealing Current field, use the **SPACEBAR** to toggle to the desired value.
- 4 Move to the next option. Continue until you have completed your changes.
- 5 Move to the Accept ISDN Option Changes field, and press **ENTER** to accept the changes.
- 6 Press **ESC** to move up a menu level, or **CTRL + R** to return to the PAU/PMU Main menu.

ISDN Alarm Thresholds Screen

The fields on this screen are measured hourly and daily:

- COLU/RT Customer and Network Hourly ES - An ISDN hourly ES alarm is generated if the accumulated hourly ES count at the COLU/RT reaches or exceeds this threshold value. A single threshold value is used for thresholding errors in the customer or network direction. The range of values is from 1 to 255. The default value is 40.
- COLU/RT Customer and Network Daily ES - An ISDN daily ES alarm is generated if the accumulated daily ES count at the COLU/RT reaches or exceeds this threshold value. A single threshold value is used for thresholding errors in the customer or network direction. The range of values is from 1 to 4095. The default value is 100.
- COLU/RT Customer and Network Hourly SES - An ISDN hourly SES alarm is generated if the accumulated hourly SES count at the COLU/RT reaches or exceeds this threshold value. A single threshold value is used for thresholding errors in the customer or network direction. The range of values is from 1 to 127. The default value is 10.
- COLU/RT Customer and Network Daily SES - An ISDN daily SES alarm is generated if the accumulated daily SES count at the COLU/RT reaches or exceeds this threshold value. A single threshold value is used for thresholding errors in the customer or network direction. The range of values is from 1 to 2047. The default value is 25.

- 1 Select *CONFIG* at the menu bar and press **ENTER** to display the submenu.
- 2 Scroll to the *ISDN Alarm Thrshlds* option and press **ENTER** to view the screen:

PG-Plus CO Line Unit #1		
MAIN	PERFORMANCE	ALARMS
CONFIG TEST INFO		
ISDN Alarm Thrshlds		
ISDN ALARMS	ALARM THRESHOLD	
COLU Customer and Network Hourly ES :	040	(1..255)
RLU Customer and Network Hourly ES :	040	(1..255)
COLU Customer and Network Daily ES :	0100	(1..4095)
RLU Customer and Network Daily ES :	0100	(1..4095)
COLU Customer and Network Hourly SES :	010	(1..127)
RLU Customer and Network Hourly SES :	010	(1..127)
COLU Customer and Network Daily SES :	0025	(1..2047)
RLU Customer and Network Daily SES :	0025	(1..2047)
ACCEPT ISDN ALARM THRESHOLD CHANGES		
01/01/1970	SYSTEM ID. PG-PLUS SYSTEM	05.01.37

- 3 At the COLU Customer and Network Hourly ES field, type in the desired value.
- 4 Move to the next option. Continue until you have completed your changes.
- 5 Move to the Accept ISDN Option Changes field, and press **ENTER** to accept the changes.
- 6 Press **ESC** to move up a menu level, or **CTRL + R** to return to the PAU/PMU Main menu.

ISDN Alarm Types Screen

Allows the provisioning of the alarm types. Table 11 shows the ISDN Alarms, the possible alarm Types, and the default factory settings. All Alarm fields can be set to Major, Minor, or Not Alarmed.

- 1 Select *CONFIG* at the menu bar and press **ENTER** to display the submenu.
- 2 Scroll to the *ISDNn Alarm Types* line and press **ENTER** to view the screen:

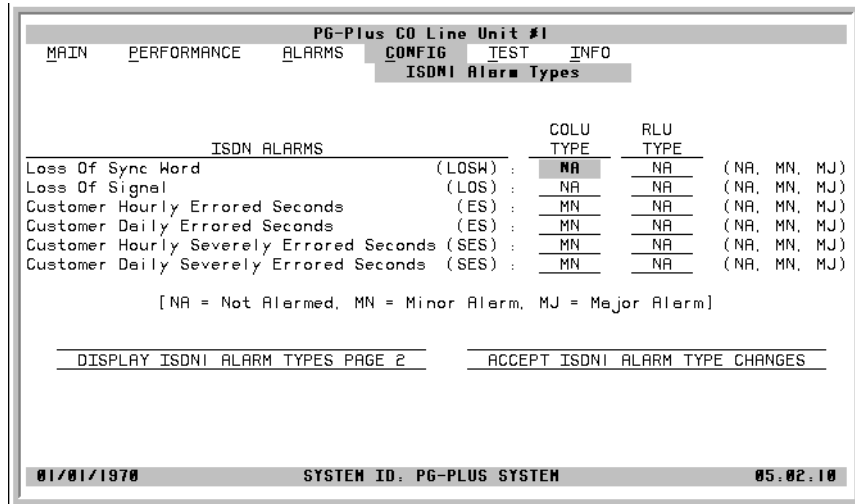

- 3 At the LOSW field, use the **SPACEBAR** to toggle to the desired value.
- 4 Move to the next option. Continue until you have completed your changes.
- 5 Move to the Display ISDN Alarm Types Page 2 field and press **ENTER**.

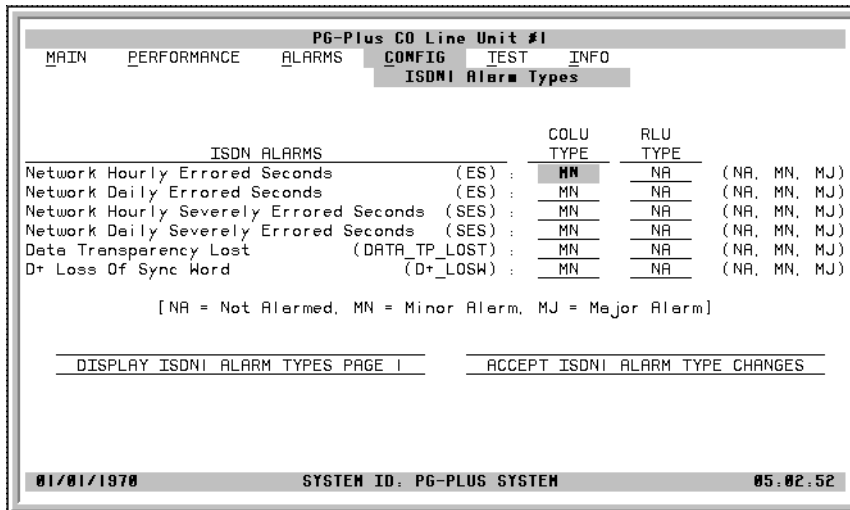

- 6 At the Network Hourly Errored Seconds field, use the **SPACEBAR** to toggle to the desired value.
- 7 Move to the next option. Continue until you have completed your changes.
- 8 Move to the Accept ISDNn Alarm Type Changes field, and press **ENTER** to accept the changes.
- 9 Press **ESC** to move up a menu level, or **CTRL + R** to return to the PAU/PMU Main menu.

Table 11. ISDN Alarms

Abbreviation	Description	Default
LOS	ISDN loss of signal condition at COLU and RT.	MN
LOSW	ISDN loss of SYNC word condition at COLU and RT.	MN
ES	ISDN hourly and/or daily ES count has reached or exceeded the configured value at COLU and RT.	MN
SES	ISDN hourly and/or daily SES count has reached or exceeded the value at the COLU and RT.	MN
DATA-TP-LO ST	An unusually high number of bit errors have been detected on the ISDN link at the COLU and RT.	MN
D+-LOSW	ISDN M-channel framing pattern has been lost on the HDSL link.	MN

Save Configuration Screen

At this screen you can save your configuration changes in nonvolatile memory.



Changes made through all other configuration screens do not become permanent changes until the changes are saved through the Save Configuration screen.

- 1 Select *CONFIG* at the menu bar and press **ENTER** to display the submenu.
- 2 Scroll to the *Save Configuration* option and press **ENTER** to view the screen:

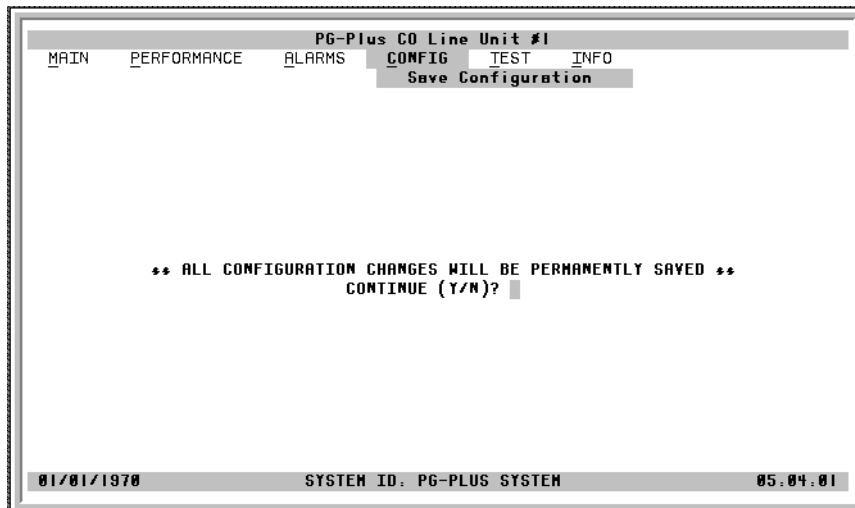

- 3 Type **Y** at the Continue? prompt to save the changes you made, or **N** to leave the values in their original setting. A confirmation message is displayed.

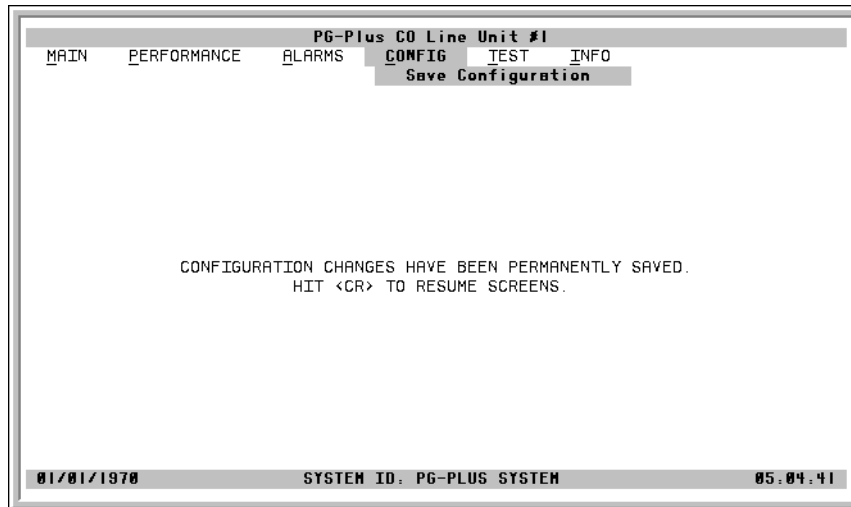

- 4 Press **ESC** to move up a menu level, or **CTRL + R** to return to the PAU/PMU Main menu.

Set Factory Defaults Screen

Sets all configuration data back to factory default values.

- 1 Select *CONFIG* at the menu bar and press **ENTER** to display the submenu.
- 2 Scroll to the *Set Factory Defaults* option and press **ENTER** to view the screen:

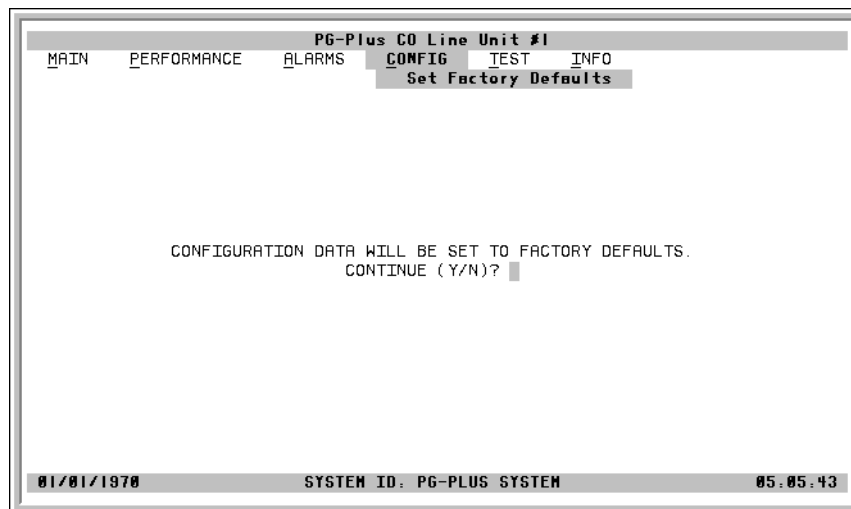

- 3 Type **Y** at the Continue? prompt to reset the system to the Factory Default values, or **N** to leave the values as is. A confirmation message is displayed.

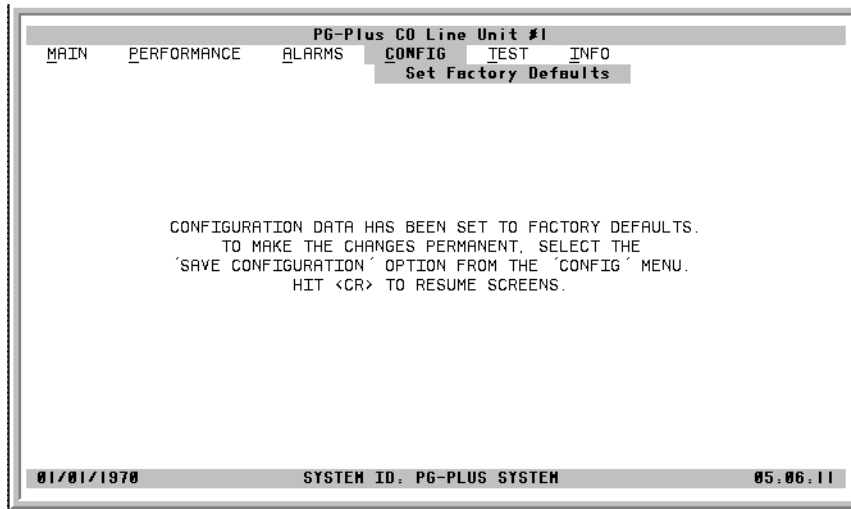

- 4 Press **ESC** to move up a menu level, or **CTRL + R** to return to the PAU/PMU Main menu.



This does not make the configuration changes permanent. The *Save Configuration* option must be used to make the changes permanent.

TEST SUBMENU

PG-Plus supports testing of a subscriber drop in two ways. A test can be initiated by applying a test voltage between the Tip and Ring at the COLU through an MLT test set, or by selecting it from the menu item through the VT-100 terminal connected to the PAU/PMU maintenance port. The relays in the COLU and RT provide a path for performing a SDT.

- 1 Select *Test* at the menu bar and press **ENTER** to display the submenu.
- 2 Scroll to the desired *ISDNn* option and press **ENTER** to start the test:

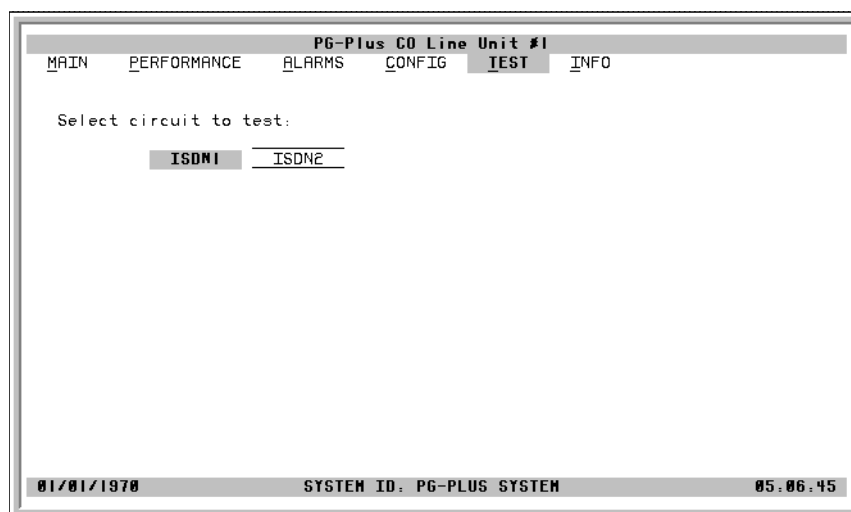

- 3 Move to the desired circuit to test and press **ENTER**.

- 4 A warning displays when a channel is selected for the test.

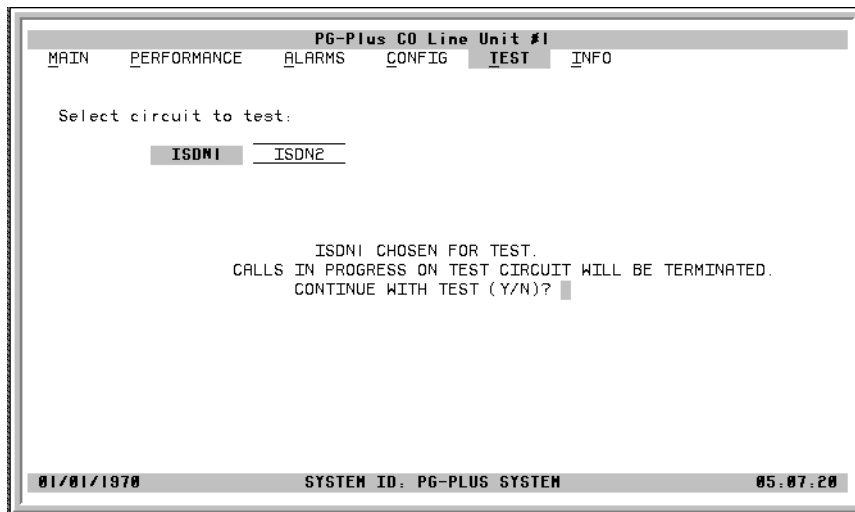

- 5 Type **Y** at the Continue With Test? prompt. A Test In Progress message displays on the screen throughout the test.



Performing an SDT on one of the ISDN channel interrupts service on the line under test. The remaining lines on the PG-Plus system remains in service.

Upon tests completion, the SDT Results screen with the Subscriber Test, Failure Condition, and Test Status results displays. Tests are performed in the order of display. If a test fails, the remaining tests are not performed (as per TR-909). It takes approximately 7 to 8 seconds for all tests to complete.

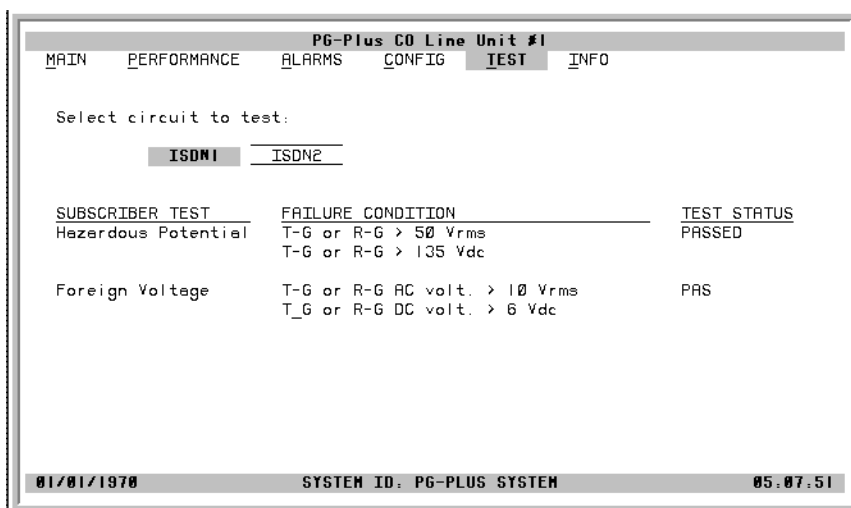

- 6 Press **ESC** to move up a menu level, or **CTRL + R** to return to the PAU/PMU Main menu.

INFORMATION SUBMENU

Provides technical information about the COLU and contact information for ADC Technologies, Inc.

- 1 Select *INFO* from the menu and press **ENTER** to view the submenu.

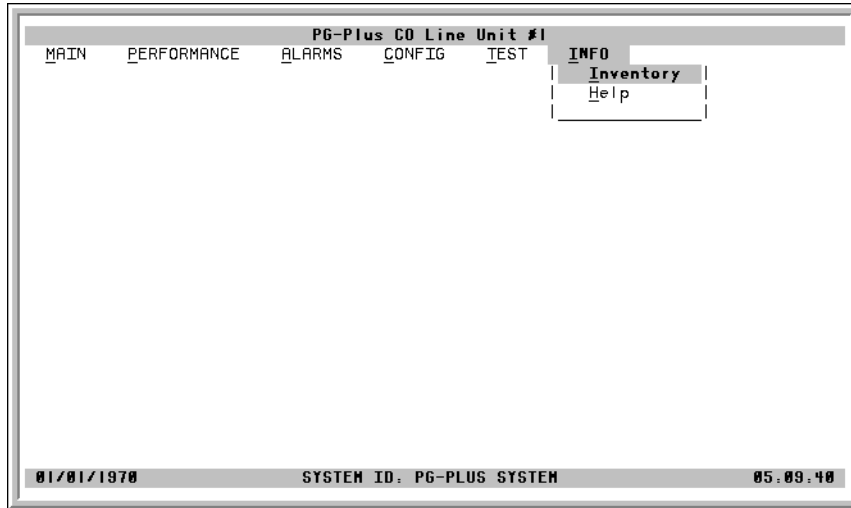

- 2 Select either *Inventory* or *Help* to view the associated screen.
- 3 Press **ESC** to move up a menu level, or **CTRL + R** to return to the PAU/PMU Main menu.

Inventory Screen

Displays all the critical information about the COLU and RT. Press **ESC** to move up a menu level, or **CTRL + R** to return to the PAU/PMU Main menu.

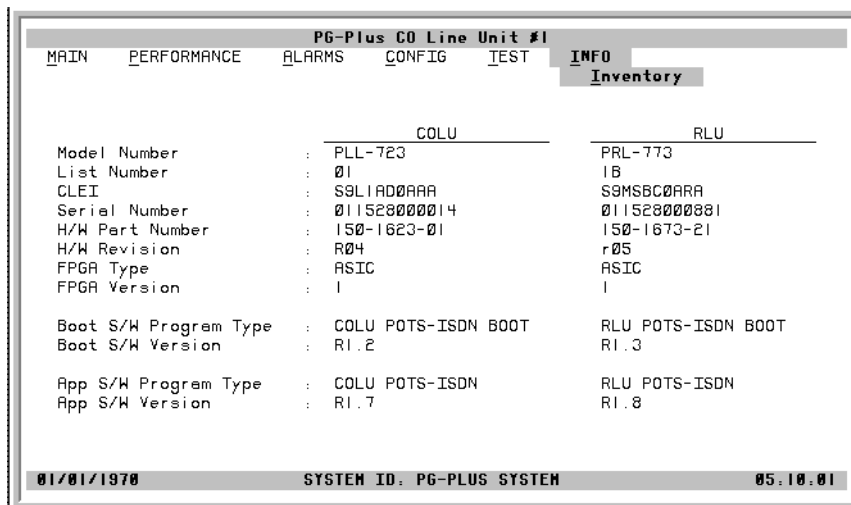

Help Screen

Provides information on using the screens and menus. The Help screen also lists the ADC Customer Support and Bulletin Board telephone numbers. Press **ESC** to move up a menu level, or **CTRL + R** to return to the PAU/PMU Main menu.

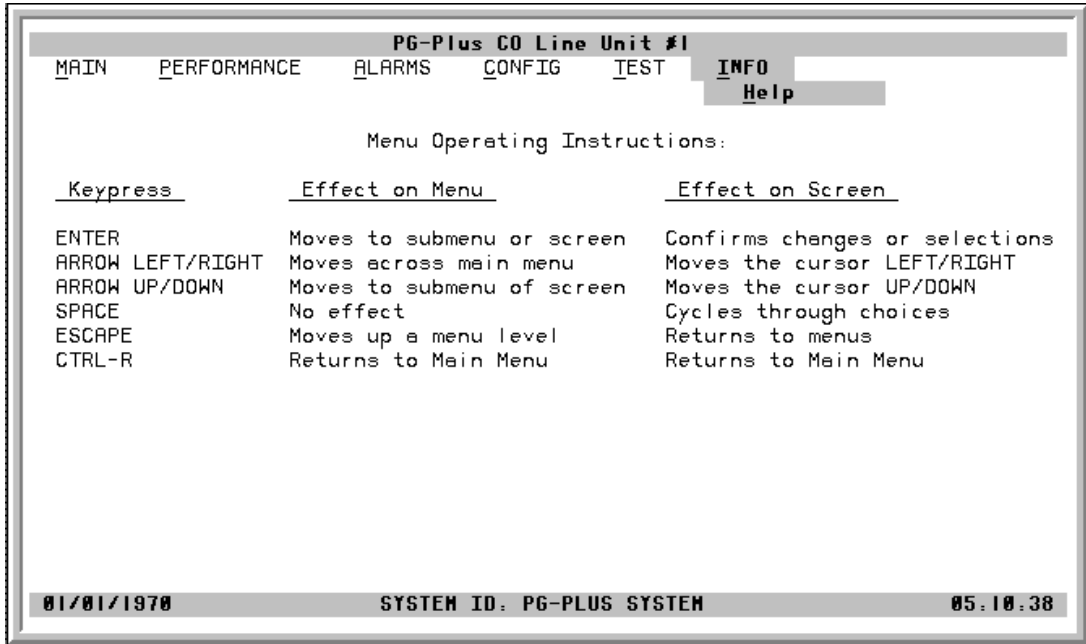

FAULT ISOLATION

The following section details the fault isolation procedures. For a condition such as “distance limitation exceeded,” refer to “Specifications” on page 2 for these values.

COLU AND RT FAULT INDICATORS

At the CO, you can use the Craft interface to initiate a SDT to determine the cause of any of the following problems. The SDT test performs Hazardous Potential, Foreign Voltage, Resistive Faults, Receiver Off-Hook, and Ringers Tests. At the customer site, the following sections provide procedures for isolating faults indicated by the COLU LEDs.

LED	Mode	Condition	Procedure
None	On	processor in the COLU stopped	1 Remove and re-insert the COLU.
			2 At the VT-100 interface, go to the COLU Main screen to view the Performance report to verify that no alarms exist. If the COLU Main screen cannot be viewed, a communication error exists, indicating a faulty COLU.
			3 If the LEDs do not illuminate, replace the COLU.
Fault	On	indicates an existing alarm condition on the COLU	1 At the VT-100 interface, go to the COLU Main screen to view the Performance report to determine the cause of the alarm. Correct the condition, if possible. If the COLU Main screen cannot be viewed, a communication error exists.
			2 Remove and re-insert the COLU.
			3 If the communication error still exists, replace the COLU.
Margi n	On	distance limitation exceeded	1 At the VT-100 interface, go to the COLU Main screen to view the Performance report to verify that no alarms exist.
		fault in HDSL line	2 Initial installation, check engineering records for distance between COTS and RT.
		faulty COLU	3 If existing installation, measure loss of HDSL line to ensure that the maximum attenuation value has not been exceeded.
			4 Replace COLU or the RT or both.
Margi n	Flashing	distance limitation exceeded	1 Initial installation, check engineering records for distance between COTS and RT.
		fault in HDSL line	2 If existing installation, measure loss of HDSL line to ensure that the maximum attenuation value has not been exceeded.
		faulty RT	3 Replace the COLU or the RT or both.
SYNC	Off	HDSL line has lost synchronization	1 Initial installation, check engineering records for distance between COTS and RT.
		distance limitation may have been exceeded	2 If existing installation, measure loss of HDSL line to ensure that the maximum attenuation value has not been exceeded.
		COLU is faulty	3 Replace the COLU or the RT or both.

LED	Mode	Condition	Procedure
PWR	Off	no input power	1 Ground fault condition exists.
		on-board fuse is blown on COLU	2 Check input power at COTS backplane with COLU removed. 3 If power is present at COTS backplane, replace the COLU.
PWR	Flashing	HDSL line open	1 Check line continuity and resistance.
		an overload exists	2 COLU power supply or RT may be faulty.
ISDNn Activity	Off	ISDN channel is not active	1 Make sure the customer ISDN terminal equipment is connected and operational at RT. 2 Check that the HDSL link is normal. The HDSL SYNC LED should be On green and the HDSL Margin LED should be Off. 3 Disconnect the customer side terminal equipment by opening the protector module and disconnecting the ISDN RJ-11 jack. Configure the ISDN Basic Rate Test set and verify the ISDN activity LED is On green after approximately 30 seconds. Check for shorts or opens towards the subscriber side or on the customer premises.

PRODUCT SUPPORT

TECHNICAL SUPPORT

Technical Assistance is available 24 hours a day, 7 days a week by the contacting Customer Service Engineering group at:

Telephone: 800.366.3891
The 800 telephone support line is toll-free in the U.S. and Canada.

Email: wsd_support@adc.com

Knowledge Base: http://adc.com/Knowledge_Base/index.jsp

Web: www.adc.com

LIMITED WARRANTY

Product warranty is determined by your service agreement. Refer to the ADC Warranty/Software Handbook for additional information, or contact your sales representative or Customer Service for details.

RETURNS

To return equipment to ADC:

- 1 Locate the number of the purchase order under which the equipment was purchased. To obtain a return authorization number, you need to provide the original purchase order number to ADC's Return Material Authorization (RMA) Department.
- 2 Call or write ADC's RMA Department to ask for an RMA number and any additional instructions. Use the telephone number, fax number or email address listed below:
 - Telephone: 800.366.3891
 - Email Address: rma@ADC.com
- 3 Include the following information, in writing, along with the equipment you are returning:
 - Company name and address.
 - Contact name and telephone number.
 - The shipping address to which ADC should return the repaired equipment.
 - The original purchase order number.
 - A description of the equipment that includes the model and part number of each unit being returned, as well as the number of units that you are returning.
 - The reason for the return. For example:
 - The equipment needs an ECO/ECN upgrade.
 - The equipment is defective.



If the equipment is defective, please tell us what you observed just before the equipment malfunctioned. Be as detailed in your description as possible.

If there is another reason for returning the equipment, please let us know so we can determine how best to help you.

- 4 Pack the equipment in a shipping carton.
- 5 Write ADC's address and the RMA Number you received from the RMA Department clearly on the outside of the carton and return to:

ADC DSL Systems, Inc.
14352 Franklin Ave.
Tustin, CA 92780-7013

Attention: **RMA (Number)**



All shipments are to be returned prepaid. ADC will not accept any collect shipments.

FCC CLASS A COMPLIANCE

This equipment has been tested and found to comply with the limits for a Class A digital device, pursuant to Part 15 of the FCC rules. These limits are designed to provide reasonable protection against harmful interference when the equipment is operated in a commercial environment. This equipment generates, uses and can radiate radio frequency energy and, if not installed and used in accordance with the instruction manual, may cause harmful interference to radio communications. Operation of this equipment in a residential area is likely to cause harmful interference in which case the user will be required to correct the interference at his own expense.

Modifications

The FCC requires the user to be notified that any changes or modifications made to this device that are not expressly approved by ADC voids the user's warranty.

All wiring external to the product(s) should follow the provisions of the current edition of the National Electrical Code.

ACRONYMS

ACO	Alarm Cut-Off
AWG	American Wire Gauge
BER	Bit Error Rate
CEV	Controlled Environmental Vault
CO T	Telco Central Office
COLU	PG-Plus Central Office Line Unit
COTS	PG-Plus Central Office Terminal Shelf
CPE	Customer Premises Equipment
CR	Critical
ES	Errored Seconds
HDLSL	High-Bit-Rate Digital Subscriber Line
ISDN	Integrated Services Digital Network
LED	Light Emitting Diode
LOSW	HDLSL Loss of SYNC Word
mA	Milli-Amps
mV_{pp}	Milli-Volt Peak-to-Peak
MAR	HDLSL line margin
MISPWRA	power A missing
MISPWRB	power B missing
MJ	Major
UART	Universal Asynchronous Receiver Transmitter
MLT	Mechanized Loop Testing
MN	Minor
NA	Not Alarmed
NORLUSW	No RT Software
NR	Not Reported
NT1	Network Termination Type-1
PAU	PG-Plus Alarm Unit
PFO	Power Feed Open
PFS	Power Feed Short
PGF	Power Feed Ground Fault
PMU	PG-Plus Management Unit
PMX	PG-Plus Multiplexer Unit
POTS	Plain Old Telephone Service
RLU	PG-Plus Remote Line Unit
RMA	Return Materials Authorization
RT	PG-Plus Remote Terminal
SDT	Subscriber Drop Test
SES	Severely Errored Seconds
SYNC	Synchronization
UAS	Unavailable Seconds Counts

World Headquarters:

ADC Telecommunications, Inc.
12501 Whitewater Drive
Minnetonka, Minnesota USA 55343

For Technical Assistance:

800.366.3891



1251789
