

PG-Flex

24 Channel

Remote Terminal Line Unit

Technical Practice



Model	List	CLEI Code
FRL-842	1B	VAR1KHLA~~

REVISION HISTORY

Revision	Release Date	Revisions Made
01	July 25, 2002	Initial Release
02	September 30, 2002	Misc. software updates
03	January 6, 2002	Updated Product Support Information

Copyright © 2003 ADC DSL Systems, Inc. All Rights Reserved.

ADC is a registered trademark of ADC Telecommunications, Inc. PG-Flex is a registered trademark of ADC DSL Systems, Inc. No right, license, or interest to such trademarks is granted hereunder, and you agree that you shall assert no such right, license, or interest with respect to such trademarks.

Other product names mentioned in this document are used for identification purposes only and may be trademarks or registered trademarks of their respective companies.





Information contained in this document is company private to ADC DSL Systems, Inc., and shall not be modified, used, copied, reproduced or disclosed in whole or in part without the written consent of ADC.

Contents herein are current as of the date of publication. ADC reserves the right to change specifications at any time without notice. Information furnished by ADC is believed to be accurate and reliable. In no event shall ADC be liable for any damages resulting from the loss of data, loss of use, or loss of profits and ADC further disclaims any and all liability for indirect, incidental, special, consequential or other similar damages. This disclaimer of liability applies to all products, publications and services during and after the warranty period.

USING THIS TECHNICAL PRACTICE

The following style conventions and terminology are used throughout this guide.

Element	Meaning
Bold font	Text that you must input exactly as shown (e.g., type 1 for card 1), menu buttons (e.g., ACCEPT SHELF OPTIONS) or menu screen options (e.g., ALARMS screen) that you must select
Italic font	Variables that you must determine before inputting the correct value (e.g., <i>Password</i>)
Monospace font	References to screen prompts (e.g., Invalid Password...Try Again:.)

Reader Alert	Meaning
	Alerts you to supplementary information
IMPORTANT 	Alerts you to supplementary information that is essential to the completion of a task
	Alerts you to possible equipment damage from electrostatic discharge
CAUTION	Alerts you to possible data loss, service-affecting procedures, or other similar type problems
	Alerts you that failure to take or avoid a specific action might result in hardware damage or loss of service
	Alerts you that failure to take or avoid a specific action might result in personal harm

INSPECTING YOUR SHIPMENT

Upon receipt of the equipment:

- Unpack each container and visually inspect the contents for signs of damage. If the equipment has been damaged in transit, immediately report the extent of damage to the transportation company and to ADC. Order replacement equipment, if necessary.
- Check the packing list to ensure complete and accurate shipment of each listed item. If the shipment is short or irregular, contact ADC as described in [Product Support on page 139](#). If you must store the equipment for a prolonged period, store the equipment in its original container.

Table of Contents

Revision History	i
Using this Technical Practice	ii
Inspecting Your Shipment	ii
Overview	1
Description	2
Functions and Features	3
Subscriber Drop Testing	3
HDSL Transmission	4
Specifications	5
Front Panel	6
Installation and Test	8
Required Tools and Test Equipment	8
Installation	8
Install the FRL-842	9
Initialize and Power Up the FRL-842	10
Administration	11
Front Panel Craft Port to Terminal Connections	11
Navigational Methods	13
Testing, Configuration, and Maintenance	14
Menus and Display Structure	14
Log On Directly Through The FRL-842	17
Main Menu Options	20
MAIN — System Summary	21
MAIN — Logout	25
Performance Menu Options	27
PERFORMANCE — HDSL Summary	29
PERFORMANCE — HDSL 24 Hour History	32
PERFORMANCE — HDSL 7 Day History	35
PERFORMANCE — ISDN Summary	38
PERFORMANCE — ISDN 7 Hour History	41
Alarm Menu Options	44
ALARMS — Alarms Summary	46
ALARMS — COLU System History (Integrated)	49
ALARMS — COLU System History (Universal)	52
ALARMS — RTLU System History	55

ALARMS — HDSL History	58
ALARMS — ISDN History	61
ALARMS — CU History	66
ALARMS — COLU Faults	69
ALARMS — RTLU Faults	70
Configuration Menu Options	71
CONFIG — System Options	75
CONFIG — COLU System Alarm Type	80
CONFIG — RTLU System Alarm Types	85
CONFIG — HDSL Alarm Thresholds	88
CONFIG — HDSL Alarm Types	91
CONFIG — ISDN Options	94
CONFIG — ISDN Alarm Thresholds	97
CONFIG — ISDN Alarm Types	100
CONFIG — Channel Unit Alarm Types	103
CONFIG — POTS Options	106
CONFIG — LS/GS Options (Integrated)	109
CONFIG — LS/GS Options (Universal)	110
CONFIG — Set Factory Defaults	113
CONFIG — Timeslot Configuration (Integrated)	115
Timeslot Mapping	115
CONFIG — Channel Configuration (Universal)	119
TEST — Subscriber Drop Test	123
Information Menu Options	126
INFO — LU Inventory	127
INFO — COCU Inventory (Universal)	128
INFO — RTCU Inventory	129
INFO — Doublers	130
INFO — Common Cards	131
INFO — Help	132
Fault Isolation and Troubleshooting	133
Subscriber Reported Faults	134
Appendix A	135
Acronyms	137
Product Support	139
Technical Support	139
Limited Warranty	139

Returns	139
FCC Class B Compliance	140
Modifications	140

List of Figures

Figure 1.	Typical Integrated Configuration	2
Figure 2.	Typical Universal Configuration	2
Figure 3.	FRL-842 Front Panel	6
Figure 4.	Typical FRL-842 Installation	9
Figure 5.	Front Panel Craft Port to Terminal Connections	11
Figure 6.	Terminal Menu and Display Structure (Integrated)	15
Figure 7.	Terminal Menu and Display Structure (Universal)	16

List of Tables

Table 1.	HDSL Distances	4
Table 2.	Specifications	5
Table 3.	FRL-842 Front Panel LEDs	7
Table 4.	FRL-842 LED Status	10
Table 5.	Craft Port Configuration	12
Table 6.	Navigational Keystrokes	13
Table 7.	Main Menu Options	20
Table 8.	System Status	24
Table 9.	Performance Menu Options	28
Table 10.	HDSL Summary	31
Table 11.	Alarm Menu Options	45
Table 12.	Configuration Menu Options	71
Table 13.	Systems Options (Integrated)	78
Table 14.	Systems Options (Universal)	79
Table 15.	Alarm Types Reported	82
Table 16.	COLU Alarms (Integrated)	83
Table 17.	COLU Alarms (Universal)	84
Table 18.	RTLUs Alarms	87
Table 19.	HDSL Alarm Thresholds	90
Table 20.	HDSL Alarm Types	93
Table 21.	ISDN Options	96
Table 22.	ISDN Alarm Thresholds	99
Table 23.	ISDN Alarm Types	102
Table 24.	Channel Unit Alarms	105
Table 25.	POTS Options	108
Table 26.	Timeslot Configuration Options	118
Table 27.	Test Menu Options	122
Table 28.	Information Menu Options	126
Table 29.	COLU and RTLUs Fault Isolation	133
Table 30.	Subscriber Fault Isolating	134

OVERVIEW

The PG-Flex® FRL-842 List 1B 24 Channel Remote Terminal Line Unit (RTL) is located in a Remote Terminal (RT) Enclosure. The system uses High-bit-rate Digital Subscriber Line (HDSL) 2B1Q technology to transport 24 DS0s of Plain Old Telephone Service (POTS) and Integrated Services Digital Network (ISDN) services between the FLL-812 Universal Central Office Line Unit (FUCOLU) or the FLL-814 Integrated Central Office Line Unit (FICOLU) and the FRTL. The FRTL is line powered from the Central Office (CO).



The default configuration in the FRL-842 is set from the FLL-812 or FLL-814, depending on which card is installed in the COT. All screens in this manual were captured with an Integrated FLL-814 installed in the COT; therefore, the screen banners and System ID reads PG-FLEXPLUS. When viewing screens with a Universal FLL-812 installed in the COT, the screen banners and System ID reads PG-FLEX.



Throughout this document, the FRL-842 is referred to as FRTL.



All references to a VT-100 terminal imply that a Personal Computer running VT-100 terminal emulation software can also be used for accessing the FRTL through the Management Unit.

IMPORTANT



Please refer to Appendix A on page 135 to facilitate proper system configuration. The Feature Matrix identifies the major features in the CO and RT line units. The Compatibility Matrix provides CO and RT line unit compatibility information.

DESCRIPTION

A typical integrated system configuration is comprised of a FICOLU in the CO, one FRTLUI and up to three Remote Terminal Channel Units (RTCUs) at the RT (Figure 1). Up to eight integrated systems can be supported in a 23-inch Central Office Terminal (COT) Shelf. A management unit, common to all systems installed in the COT Shelf, provides an interface for alarm relays and testing of subscriber circuits. A multiplexer card takes the DS0s from the system and converts them to D4, ESF, or TR-08 DS1 signals at DSX-1 levels.

A typical universal system is comprised of one line unit and from one to three channel units at both the COT and RT (Figure 2). The COT shelf supports up to four systems. The channel unit card in the COT must be the same type of slot specific card (POTS or ISDN) as the channel unit installed at the RT. A PG-Flex FPI-829 Pair Gain Test Controller (PGTC) Interface Unit (common to all systems installed in the shelf) provides an interface for maintenance, alarm relays, and metallic access to the remote subscriber lines.

The remote end of the system is housed in a RT Enclosure. RT Enclosures are designed for outdoor and indoor applications and are provided with a diverse selection of mounting options. These RT Enclosures support one or more systems that include one FRTLUI and up to three RTCUs for each system.

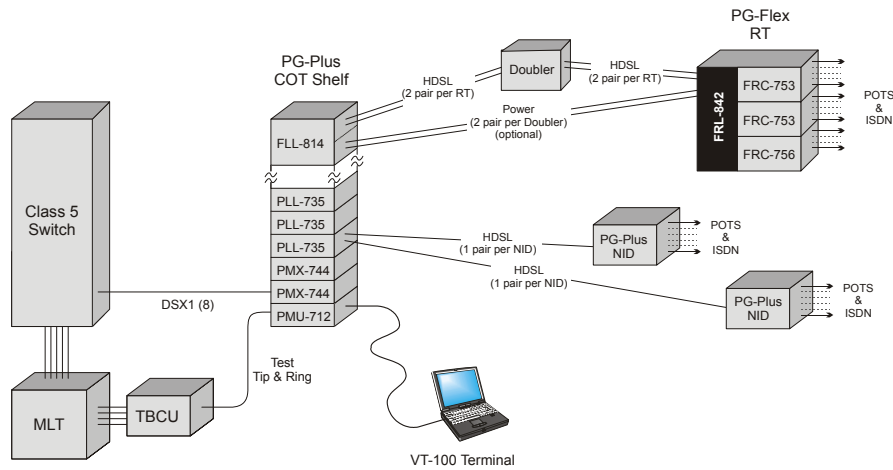

Figure 1. Typical Integrated Configuration

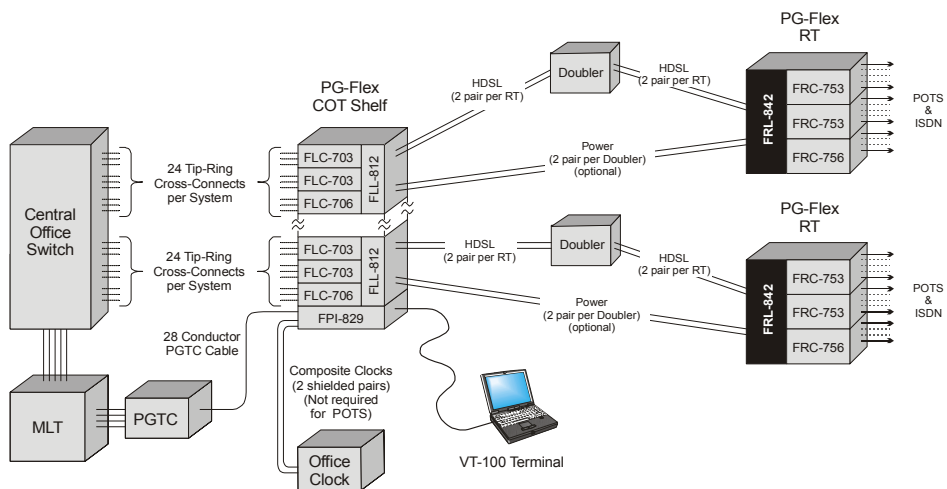

Figure 2. Typical Universal Configuration

FUNCTIONS AND FEATURES

The FLL-842 FRTLTLU provides the following functions and features:

- Line powered from COLU
- HDSL line transceivers and power supply
- Front panel status indicators
- Downloadable firmware
- Environmental Alarms
- Support for FFU-865 (Fan Card) and associated alarm
- Mechanized Loop Test (MLT) test system compatibility
 - TR-909
 - Bypass

The FRL-842 is compatible with Mechanized Loop Testing (MLT). It includes an internal test head for determining the condition of the subscriber drop. Test results are reported to the test system using TR-909-compliant resistive signatures.

SUBSCRIBER DROP TESTING

The FRL-842 supports subscriber drop testing using an internal test head that eliminates the metallic bypass pair.

This test head reports its results through the Flex PGTC Interface Unit (FPI-829) (for universal systems) or management unit (PMU-712) (for integrated systems) using three-terminal signature resistors that are measured by MLT and converted to subscriber drop condition messages that can be viewed on the VT-100 terminal as described in [TEST — Subscriber Drop Test on page 123](#).



To use the internal test head in the RTLTLU, a FPI-829 (for universal systems) or PMU-712 (for integrated systems) must be installed in the COT Shelf.

HDSL TRANSMISSION

The system uses HDSL 2B1Q technology to transport 24 DS0s, plus signaling over two copper pairs. The HDSL circuits can be used without repeaters, loop conditioning, or pair selection. Adaptive equalization, scrambling, and a four-level 2B1Q line coding scheme are used to maximize distance and minimize crosstalk.

Table 1 shows the maximum distance between the COT and RT for various wire gauges doubler combinations in the circuit. These distances are shown for a cable temperature of 68° F (20° C). As the temperature of the cable increases, the distance decreases.

Table 1. HDSL Distances

Wire Gauge	HDSL Distance (6 dB Margin / 35 dB Loss / 68° F)			Analog Drop (530 Ω)
	No Doubler	1 Doubler	2 Doublers	
26 AWG 0.4 mm	9.0 kft 2.8 km	18.0 kft 5.6 km	27.0 kft 8.4 km	6.3 kft 1.9 km
24 AWG 0.5 mm	12.3 kft 3.8 km	24.6 kft 7.6 km	36.9 kft 11.4 km	10.2 kft 3.1 km
22 AWG 0.6 mm	16.1 kft 5.0 km	32.2 kft 10.0 km	48.3 kft 15.0 km	16.3 kft 5.0 km
19 AWG 0.9 mm	22.8 kft 7.0 km	45.6 kft 14.0 km	67.4 kft 21.0 km	32.9 kft 10.0 km



When the RT is powered from the COT, two auxiliary power pairs are required between the COT and RT for each doubler installed in the HDSL circuit. Refer to the COT Shelf or RT Enclosure technical practice for additional information on the power pairs.

SPECIFICATIONS

Table 2 lists the specifications for the FRL-842.

Table 2. Specifications

Category	Item	Value
Electrical	Input Voltage	130 Vdc to 270 Vdc (± 65 Vdc to ± 135 Vdc with respect to ground)
	Input Power	Less than 40 Watts
Compliance	NEBS	SR-3580 Level 3
	Human Safety	UL-1950 for Restricted Access
	Emissions Radiation and Immunity	GR-1089-CORE for Class B equipment
HDSL	Line Interface	Two pair, 784-kbps full-duplex 2B1Q transmission format
	Signal Characteristics	TR-NWT-001210, Generic Requirements for HDSL Systems
Environmental	Elevation	-200 ft. to 13,000 ft. -60 m to 4,000 m
	Temperature	-40° F to +150° F -40° C to +65° C
	Humidity	5% to 95% (non-condensing)
Physical	Height	12.0 in. (30.5 cm.)
	Width	2.2 in. (5.6 cm.)
	Depth	4.5 in. (11.4 cm.)
	Weight	1.4 lbs. (0.64 kg.)

FRONT PANEL

Figure 3 shows the FRL-842 front panel and Table 3 on page 7 describes the front panel LEDs.

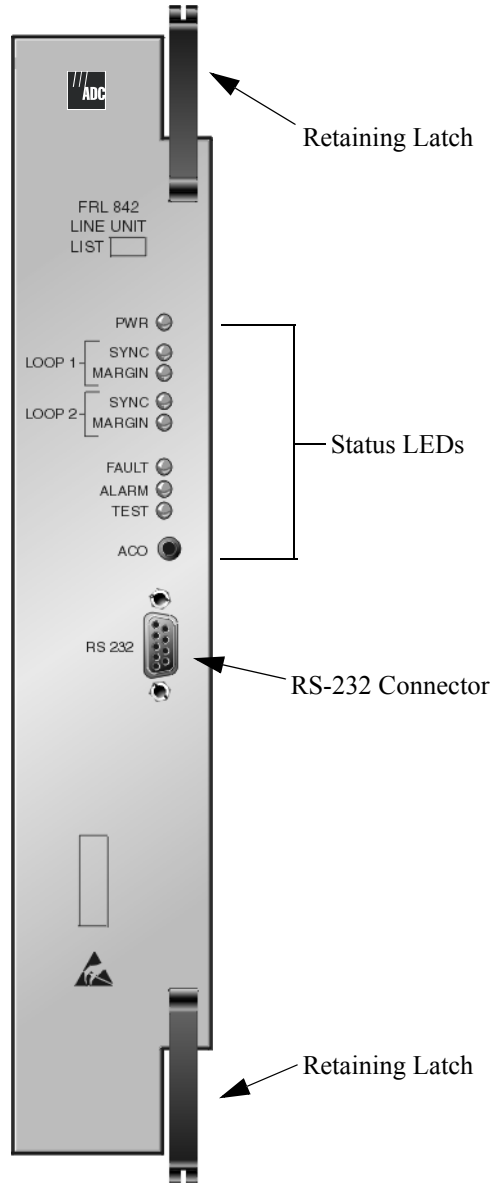

Figure 3. FRL-842 Front Panel

Table 3. FRL-842 Front Panel LEDs

LED	Color	State	Description
PWR	Green	On	FRTLUI power supply is normal
		Flashing	COLU is attempting to power-up the FRTLUI
		Off	FRTLUI is not receiving power or internal fault
LOOP 1 SYNC	Green	On	Loop 1 is in synchronization between the COLU or Doubler Unit
		Flashing	Loop 1 is attempting to synchronize with the COLU or Doubler Unit
		Off	Active COLU or Doubler Unit is not detected
LOOP 1 MARGIN	Yellow	On	Loop 1 margin at the FRTLUI is equal to or below the provisioned threshold level
		Flashing	Loop 1 margin at the COLU or Doubler Unit is equal to or below the provisioned threshold level
		Off	Loop 1 margin is above the provisioned threshold level
LOOP 2 SYNC	Green	On	Loop 2 is in synchronization between the COLU or Doubler Unit
		Flashing	Loop 2 is attempting to synchronize with the COLU or Doubler Unit
		Off	Active COLU or Doubler Unit is not detected
LOOP 2 MARGIN	Yellow	On	Loop 2 margin at the FRTLUI is equal to or below the provisioned threshold level
		Flashing	Loop 2 margin at the COLU or Doubler Unit is equal to or below the provisioned threshold level
		Off	Loop 2 margin is above the provisioned threshold level
TEST	Yellow	On	Test active
		Off	Test not active
ALARM	Red	On	FRTLUI alarm condition exist
		Flashing	COLU alarm condition exist
		Off	No alarm conditions exist
FAULT	Red	On	Fault in the FRTLUI
		Off	No fault is detected

INSTALLATION AND TEST



STATIC SENSITIVE DEVICE – DO NOT HANDLE ANY MATERIAL WITHOUT FIRST TAKING PROPER STATIC CONTROL PRECAUTIONS.

REQUIRED TOOLS AND TEST EQUIPMENT

No special tools or equipment are required to install the FRL-842.

INSTALLATION



Install the FRL-842 in the left slot of the RT Enclosure ([Figure 4 on page 9](#)).

Install the FRL-842

Step	Action
1	Open the retaining latches on the front of the FRL-842.
2	Insert the FRL-842 into the card guides.
3	Engage the retaining latches to hold the card in place.

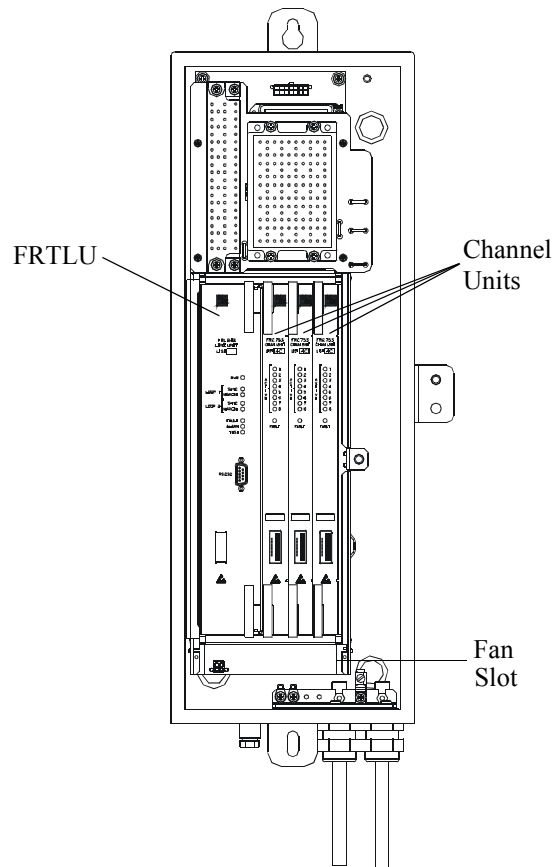

Figure 4. Typical FRL-842 Installation

Initialize and Power Up the FRL-842

By default, the COLU continuously attempts to power up and synchronize with the FRL-842 and/or Doubler Units in the circuit until end-to-end HDSL synchronization is established. If the COLU is unable to establish synchronization, it powers down the loops and waits approximately one minute before re-trying. The COLU repeats this process continuously until it is able to synchronize with the FRL-842 or doubler.



The COLU initialization and power up sequence described below assumes:

- HDSL pairs are wired from the COT shelf, through doubler housings (if required) and terminated at the RT enclosure
- Auxiliary Power pairs (when using doublers) are wired from the COT shelf and terminated at the RT enclosure (these pairs do not need to pass through the Doubler housing)
- COT shelf has been wired to CO battery
- Bay fuses have been installed
- Doublers (if required) have been installed
- FRL-842 has been installed

When the COLU synchronizes with the FRL-842 or doubler, the following occurs:

1. When the FRL-842 is installed with power applied to the COT shelf, all LEDs turn on for one second, then go off. The PWR Led remains on.
2. After a few seconds, SYNC LEDs for Line 1 and Line 2 begin to flash.
3. After 30 to 60 seconds, SYNC LEDs for Line 1 and Line 2 remain on.
4. Verify [Table 4](#) front panel indications after the system powers up and establishes HDSL synchronized communications:

Table 4. FRL-842 LED Status

LED	Status
PWR	On
LOOP 1 SYNC	On
LOOP 1 MARGIN	Off
LOOP 2 SYNC	On
LOOP 2 MARGIN	Off
TEST	Off
ALARM	Off
FAULT	Off



It takes approximately two minutes before end-to-end synchronization is established with two doublers installed in the circuit. However, depending on the condition of the cable plant and length of the spans, it may take up to four minutes before synchronization is established.

ADMINISTRATION

To use the craft interface to provision the FRL-842, you must connect a VT-100 compatible terminal or a personal computer with VT-100 terminal emulation software to the RS-232 interface of the FRL-842. The VT-100 interface allows “real time” updating of information displayed on the screen. Through the craft interface screens, system administration functions such as alarm checking and clearing, configuration changes, performance monitoring, and testing can be performed.

FRONT PANEL CRAFT PORT TO TERMINAL CONNECTIONS

Connections between the RS-232 craft port of the FRL-842 and the craft terminal are shown in [Figure 5](#).

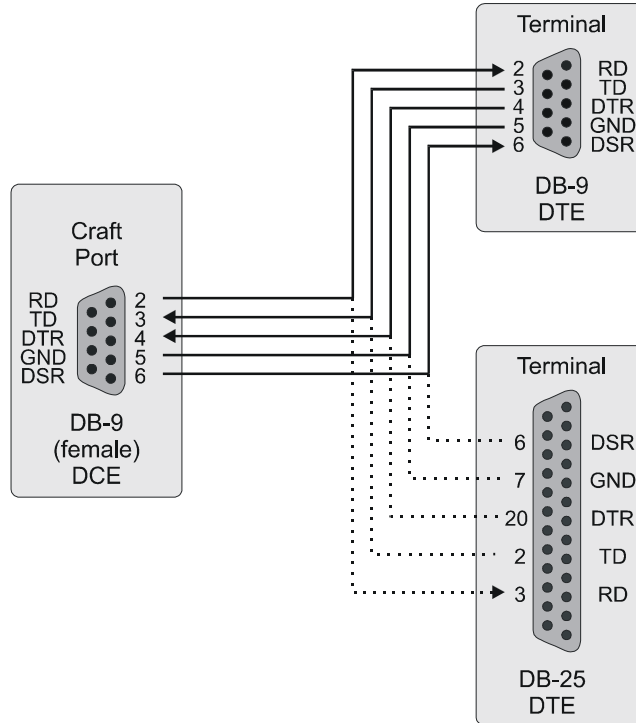

Figure 5. Front Panel Craft Port to Terminal Connections

Refer to [Table 5](#) to set up the VT-100 craft port connections.

Table 5. Craft Port Configuration

Control	Setting	Supported	Default
Software Flow Control	XON/XOFF	Enabled	Enabled
Baud Rate		1200 2400 4800 9600 19200 38400	Autobaud
Asynchronous Communication Parameters	Data Bits	8	8
	Parity	None	None
	Stop Bits	1	1

NAVIGATIONAL METHODS

Table 6 shows the keys used to navigate through the menus and screens:

Table 6. Navigational Keystrokes

Keypress	Effect on Menu	Effect on Screen
ENTER	Moves to sub-menu or screen selected	Confirms changes
← or CTRL - F	Moves left across Main Menu	Moves the cursor left
→ or CTRL - G	Moves right across Main Menu	Moves the cursor to the right
↑ or CTRL - T	Moves up the sub-menu selection	Moves the cursor up
↓ or CTRL - V	Moves down the sub-menu selection	Moves the cursor down
TAB	No effect	Moves to the next field
SPACEBAR	No effect	Cycle through the field options
ESC	Moves up a menu level. From the Main Menu, the Logout screen is displayed.	Returns to Main Menu without accepting changes. The banner briefly appears and then the Main Menu bar displays.
CTRL - R	Returns to the Main Menu. The banner briefly appears and then the Main Menu bar displays.	Returns to Main Menu without accepting changes
A - Z keys	Selects an underlined or highlighted menu item	A screen entry is made



Some screens illustrated in this document may be slightly different than what may appear on the craft interface terminal. These differences are related to individual software installations.

TESTING, CONFIGURATION, AND MAINTENANCE

The following sections describe how to navigate the VT-100 screens to configure, check the status of, and maintain the FRL-842 system.

MENUS AND DISPLAY STRUCTURE

Figure 6 on page 15 shows the menu structure of the terminal management system (Integrated setup) and Figure 7 on page 16 shows the menu structure of the terminal management system (Universal setup). In this section, the RTLU refers to the FRL-842 and the COLU refers to the FLL-814.

IMPORTANT



To make configuration changes from the RTLU, you must enable this option in the COLU. Refer to COLU documentation for information on enabling this option.



All screen captures throughout this document were captured through an Integrated setup unless otherwise specified as an Universal setup.

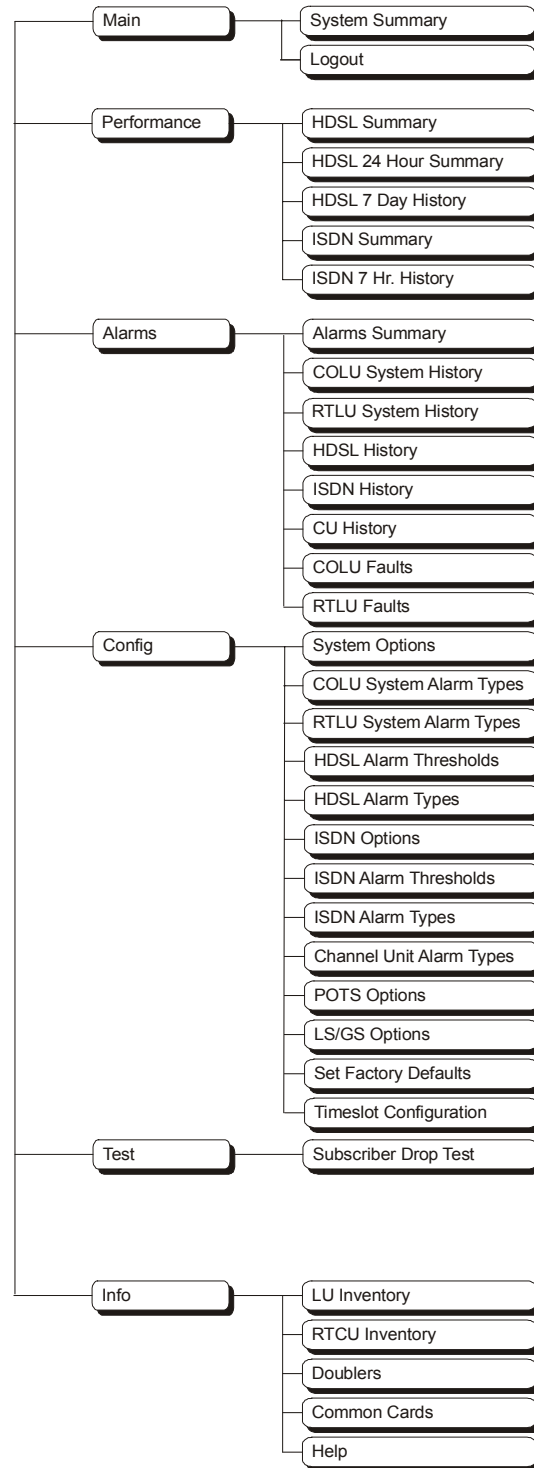

Figure 6. Terminal Menu and Display Structure (Integrated)

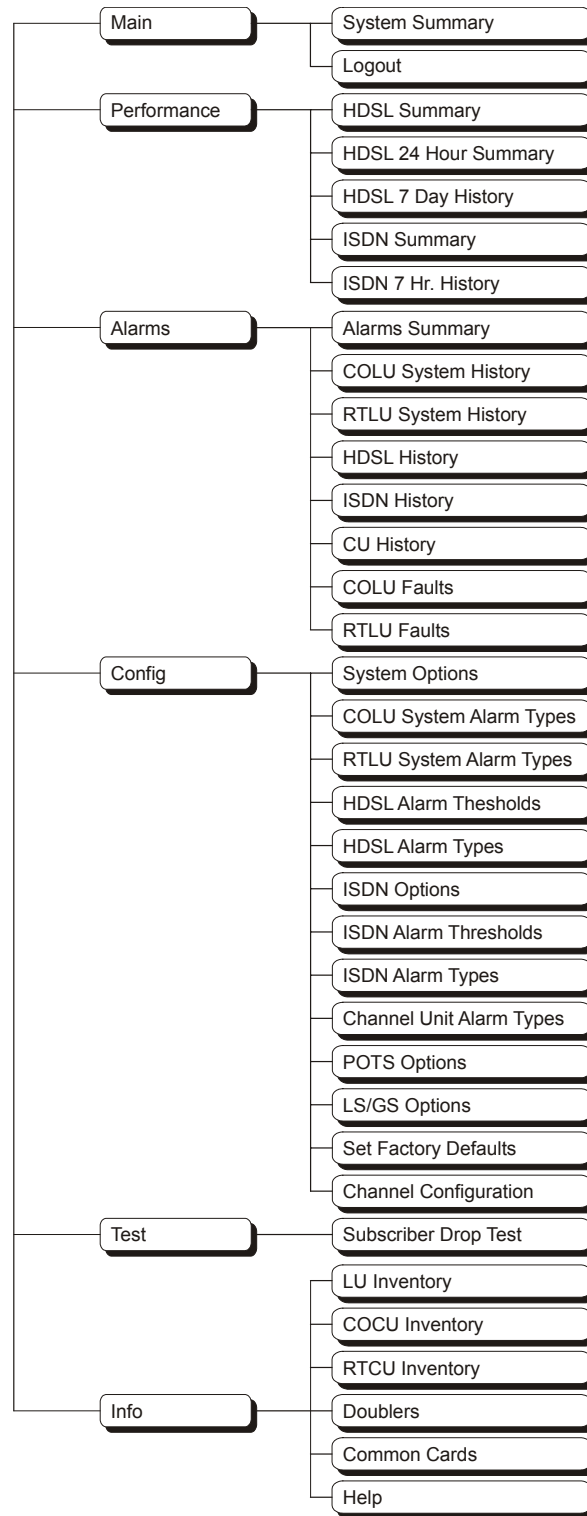

Figure 7. Terminal Menu and Display Structure (Universal)

Log On Directly Through The FRL-842

This screen logs the user into the system directly through the FRL-842.



The factory-default password is **password#1**.

If the password has been changed and the new password is not known, contact ADC Technical Support while at the terminal. Technical Support will provide a temporary password based on the Access Key number displayed on the Logon screen.



Log On Directly Through The FRL-842

Step	Action
1	<p>After connecting a VT-100 terminal to the FRL-842, press SPACEBAR several times to start the autobaud feature. The Login Password screen appears.</p> <div data-bbox="479 737 1239 1209" style="border: 1px solid gray; padding: 20px; text-align: center;"> </div>
2	<p>If an invalid <i>Password</i> is entered, the Login screen is redisplayed with the message Invalid Password...Try Again:.</p> <div data-bbox="479 1329 1239 1801" style="border: 1px solid gray; padding: 20px; text-align: center;"> </div>

Log On Directly Through The FRL-842 (Continued)

Step	Action
3	<p>Type the <i>Password</i>, then press ENTER. After a successful login, the system banner screen appears for a few seconds.</p> <div data-bbox="479 430 1239 905" style="border: 1px solid black; text-align: center; padding: 50px;">The image shows a simple banner screen with the text "PG-FlexPlus" centered in a black rectangular box.</div> <p>Then, the FRL-842 Main Menu screen appears.</p> <div data-bbox="479 978 1239 1453" style="border: 1px solid black; padding: 5px;"><pre>PG-FlexPlus AT Line Unit MAIN PERFORMANCE ALARMS CONFIG TEST INFO System Summary Logout 06/05/2002 SYSTEM ID: PG-FlexPlus 09:45:19</pre></div>

Log On Directly Through The FRL-842 (Continued)

Step	Action
4	<p>After 15 minutes of inactivity, the following menu appears.</p> <div data-bbox="479 401 1239 856"></div> <p>Press ESC. The Login screen reappears.</p> <div data-bbox="479 928 1239 1402"></div> <p>Repeat Step 1, Step 3 and Step 4 to log in again.</p>

MAIN MENU OPTIONS

The Main Menu provides access to other sub-menus to check system status information and log out of the system. Refer to **Table 7** for sub-menu options and descriptions, parameters and valid values.





Table 7. Main Menu Options

Sub-Menu Options	Sub-Menu Descriptions	Parameters	Valid Values
System Summary	System status (spans, services, channel status for each span and service)	Display Channel Status (Y)?	Y or N
Logout	Log out of the current session	Current Session will be Logged Out. Continue (Y/N)?:	Y or N

MAIN — System Summary

This screen displays the status of the system. Refer to [Table 8 on page 24](#) for System Status information.

MAIN — System Summary

Step	Action
1	<p>At the Main Menu screen, select MAIN. Press  to choose System Summary. The following screen appears.</p> 

MAIN — System Summary (Continued)

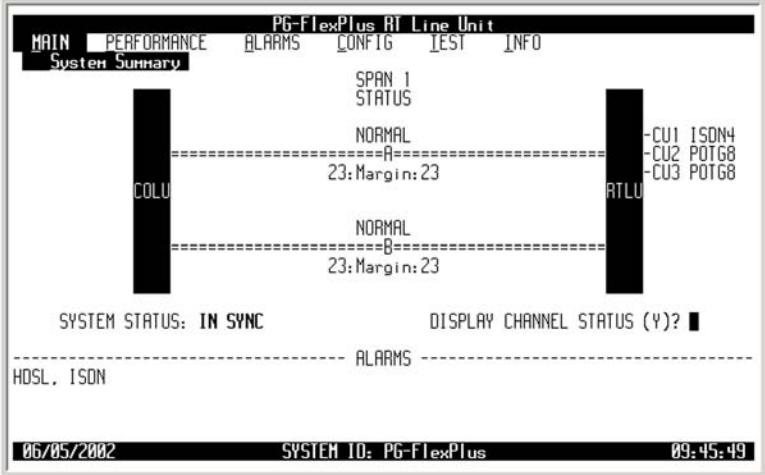
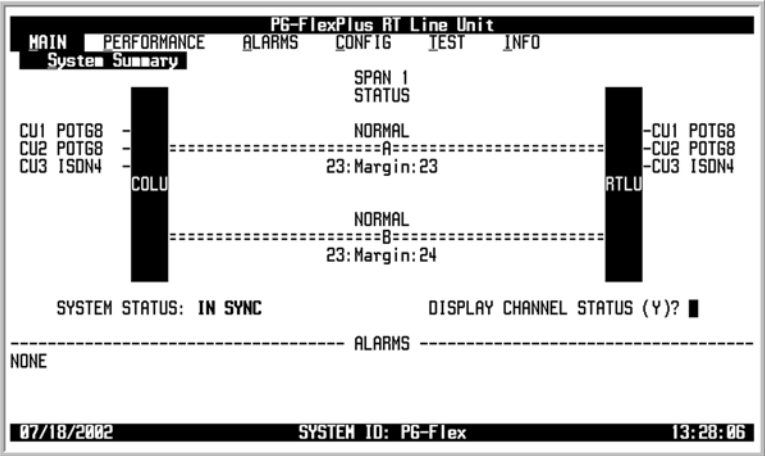
Step	Action
<p>2</p>	<p>Integrated: Press ENTER. The following screen appears.</p>  <p>Universal: Press ENTER. The following screen appears.</p> 

MAIN — System Summary (Continued)

Step	Action
3	<p>To display channel status, press Y. The following screen appears.</p> 
4	<p>Press ESC. The Main Menu screen reappears.</p>



Table 8. System Status

Status	Description
System Status	
IN SYNC	Payload synchronized between the COLU and RTLU
OUT OF SYNC	Payload is not synchronized between the COLU and RTLU
Span “N” Status (where N = 1 – 3)	
HDSL LINK DOWN	HDSL link is down
NORMAL	HDSL link is synchronized
START-UP	HDSL link is acquiring synchronization
MARGIN	Indicates current noise margin of span
Alarms	
HDSL	Summary of alarms associated with HDSL link
ISDN	Summary of alarms associated with the ISDN channels
SYSTEM	Summary of alarms within the system
Display Channel Status	
ACTIVE	ISDN link is synchronized and the m-channel “Act” bit is set in the customer direction (towards NT1) as well as network direction (towards LT)
BUSY	Voice path through system is intact, Line is off-hook at RT with or without CO battery wired
DS0AIS	DS0 is not available due to a incoming DS1 facility fault
FRAMED	ISDN start-up sequence is complete, but end-to-end transparency has not been established
IDLE	Voice path through the system is intact, no CO battery detected , Line is on-hook at RT (IDLE at CO, IDLE at RT)
INACT	“Act” bit in the ISDN m-channel is reset in the customer direction or network direction or both
LOS	Loss of signal
N/A	Not applicable, Timeslots are disabled, Channel Unit is removed at either end (CO or RT)
OPEN	Voice path through the system is intact, No CO battery detected (OPEN at CO, IDLE at RT)
RING	Line is ringing
RINGGND	Ring ground detected at the RT
TEST	Testing being done on line
TKCOND	Forced line condition
RBAT	Reverse battery

MAIN — Logout

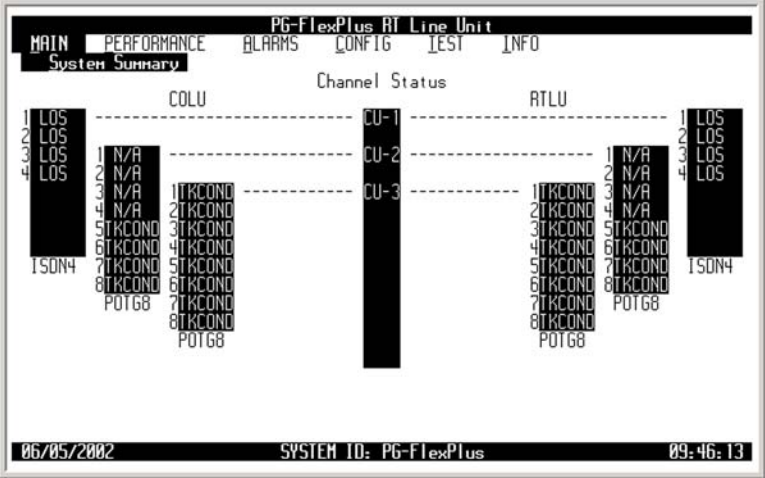
This screen logs the user out of the system.

MAIN — Logout

Step	Action
1	<p>CAUTION <i>If you must leave your VT-100 terminal unattended for any length of time, log off until you are ready to resume work. This prevents unauthorized persons from inadvertently changing any of your operating parameters and causing a possible loss of service.</i></p> <p>At the Main Menu screen, select MAIN. Press ↓ to choose Logout. The following screen appears.</p> 
2	<p>Press ENTER. The following screen appears.</p> 

MAIN — Logout (Continued)

Step	Action
3	<p>Press Y. The Login screen appears.</p> <div data-bbox="479 405 1239 877" style="border: 1px solid gray; padding: 20px; text-align: center;"><div data-bbox="654 548 1052 716" style="border: 2px solid black; padding: 10px;"><p>PG-FlexPlus Login Screen</p><p>Enter Password: <input type="password"/></p><p>Access Key: 102463010230</p></div></div>

PERFORMANCE MENU OPTIONS

The Performance Menu provides access to HDSL and ISDN status (if ISDN is installed) and performance monitoring information. Refer to [Table 9 on page 28](#) for sub-menu options and descriptions, parameters and valid values.



ISDN menu selections are only present if ISDN is installed the system.





Table 9. Performance Menu Options

Sub-Menu Options	Sub-Menu Descriptions	Parameters	Valid Values
HDSL Summary	View the HDSL performance summary and status	<ul style="list-style-type: none"> • Clear Min/Max Margins (Y)? • HDSL Low/High margins will be reset. Continue (Y/N)? 	<ul style="list-style-type: none"> • Y • Y or N
HDSL 24 Hour History	View the last 24 hours of HDSL performance history in 15 minute intervals	<ul style="list-style-type: none"> • Span • HDSL 24 Hour History will be cleared. Continue (Y/N)? 	<ul style="list-style-type: none"> • 1 • Y or N
HDSL 7 Day History	View the last 7 days of performance history, plus the current day's accumulated performance history in 24 hour intervals	<ul style="list-style-type: none"> • Span • HDSL 7 Day History will be cleared. Continue (Y/N)? 	<ul style="list-style-type: none"> • 1 • Y or N
ISDN Summary	View the stored ISDN performance data	<ul style="list-style-type: none"> • Clear ISDN PM Counts for this channel (Y)? • ISDN PM Counts will be cleared. Continue (Y/N)? 	<ul style="list-style-type: none"> • Y • Y or N
ISDN 7 Hour History	View the 7 hour ISDN ES history info	<ul style="list-style-type: none"> • Clear ISDN PM Counts for this channel (Y)? • ISDN PM Counts will be cleared. Continue (Y/N)? 	<ul style="list-style-type: none"> • Y • Y or N

PERFORMANCE — HDSL Summary

This screen displays the HDSL performance summary and status. Refer to [Table 10 on page 31](#) for HDSL Summary information.

PERFORMANCE — HDSL Summary

Step	Action
1	<p>At the Main Menu screen, select PERFORMANCE. Press ↓ to choose HDSL Summary. The following screen appears.</p> 
2	<p>Press ENTER. The following screen appears.</p>  <p>The following actions can be taken:</p> <ol style="list-style-type: none"> To clear the minimum and maximum margins, press Y and continue with this procedure. To exit the HDSL Summary, press ESC.

PERFORMANCE — HDSL Summary (Continued)

Step	Action
3	<p>The following actions can be taken:</p> <p>a. To reset the margins, press Y. The following events occur:</p> <ul style="list-style-type: none"> • minimum and maximum margins are set to the current margins • time and date that the margins were last set are updated. <div data-bbox="479 514 1242 976" style="border: 1px solid black; padding: 5px;"> <pre> PG-FlexPlus AT Line Unit MAIN PERFORMANCE ALARMS CONFIG TEST INFO HDSL Summary SPAN #1 HOSLA STATUS : NORMAL : HOSLB STATUS : NORMAL : TIP-RING REV A/B : YES/YES : LOOP REVERSAL : NO : HOSLA ES (24 Hr) : 0 0: HOSLB ES (24 Hr) : 0 0: HOSLA UAS(24 Hr) : 0 0: HOSLB UAS(24 Hr) : 0 0: HOSLA MAR(curr) : 23 23: dB HOSLA MAR(mn/mx) : 22/24 22/24: dB HOSLB MAR(curr) : 23 23: dB HOSLB MAR(mn/mx) : 23/24 23/24: dB HOSLA INSATN LOSS: 2 2: dB HOSLB INSATN LOSS: 2 2: dB CLEAR MIN/MAX MARGINS (Y)? MIN/MAX MARGINS LAST CLEARED: 06/05/2002 09:10:59 HDSL LOW/HIGH MARGINS WILL BE RESET. CONTINUE (Y/N)? 06/05/2002 SYSTEM ID: PG-FlexPlus 09:50:35 </pre> </div> <div data-bbox="479 1018 1242 1501" style="border: 1px solid black; padding: 5px;"> <pre> PG-FlexPlus AT Line Unit MAIN PERFORMANCE ALARMS CONFIG TEST INFO HDSL Summary SPAN #1 HOSLA STATUS : NORMAL : HOSLB STATUS : NORMAL : TIP-RING REV A/B : YES/YES : LOOP REVERSAL : NO : HOSLA ES (24 Hr) : 0 0: HOSLB ES (24 Hr) : 0 0: HOSLA UAS(24 Hr) : 0 0: HOSLB UAS(24 Hr) : 0 0: HOSLA MAR(curr) : 23 24: dB HOSLA MAR(mn/mx) : 23/23 24/24: dB HOSLB MAR(curr) : 23 23: dB HOSLB MAR(mn/mx) : 23/23 23/23: dB HOSLA INSATN LOSS: 2 2: dB HOSLB INSATN LOSS: 2 2: dB CLEAR MIN/MAX MARGINS (Y)? MIN/MAX MARGINS LAST CLEARED: 06/05/2002 09:50:59 06/05/2002 SYSTEM ID: PG-FlexPlus 09:51:03 </pre> </div> <p>b. To retain the existing minimum and maximum margins, press N.</p>
4	<p>Press ESC. The Main Menu screen reappears.</p>

Table 10. HDSL Summary

Parameter	Description	State or Value
<ul style="list-style-type: none"> • HDSL A STATUS • HDSL B STATUS 	Status of the HDSL A/B link on the span	<ul style="list-style-type: none"> • NORMAL <ul style="list-style-type: none"> - HDSL link and payload is synchronized • STARTUP <ul style="list-style-type: none"> - HDSL link is attempting to synchronize • LINKDOWN <ul style="list-style-type: none"> - HDSL transceiver at the far end has not been detected
TIP-RING REV A/B*	Tip-ring polarity of the HDSL A/B link	<ul style="list-style-type: none"> • NO <ul style="list-style-type: none"> - Indicates that tip and ring are wired properly • YES <ul style="list-style-type: none"> - Indicates that tip and ring are reversed
LOOP REVERSAL*	HDSL loop A/B connection	<ul style="list-style-type: none"> • NO <ul style="list-style-type: none"> - Indicates HDSL loops A and B are wired properly • YES <ul style="list-style-type: none"> - Indicates HDSL loops A and B are reversed
<ul style="list-style-type: none"> • HDSL A ES (24 Hr) • HDSL B ES (24 Hr) 	Total number of errored seconds in the last 24 hours on the HDSL A/B link	
<ul style="list-style-type: none"> • HDSL A UAS (24 Hr) • HDSL B UAS (24 Hr) 	Total number of unavailable seconds in the last 24 hours on the HDSL A/B link	
<ul style="list-style-type: none"> • HDSL A MAR (curr) • HDSL B MAR (curr) 	Current margin on the HDSL A/B link	
<ul style="list-style-type: none"> • HDSL A MAR (mn/mx) • HDSL B MAR (mn/mx) 	Minimum and maximum margins on the HDSL A/B link since the min/max margins were last cleared	
<ul style="list-style-type: none"> • HDSL A INSR TN LOSS • HDSL B INSR TN LOSS 	Loss on the HDSL A/B link	
<p>* The system works correctly with loop and/or tip and ring reversals. However, alarms are generated and fault isolation may be difficult.</p>		

PERFORMANCE — HDSL 24 Hour History

This screen displays the last 24 hours of HDSL performance history in 15 minute intervals. The performance history data displayed includes ES and UAS counts and the status of these counts.

PERFORMANCE — HDSL 24 Hour History

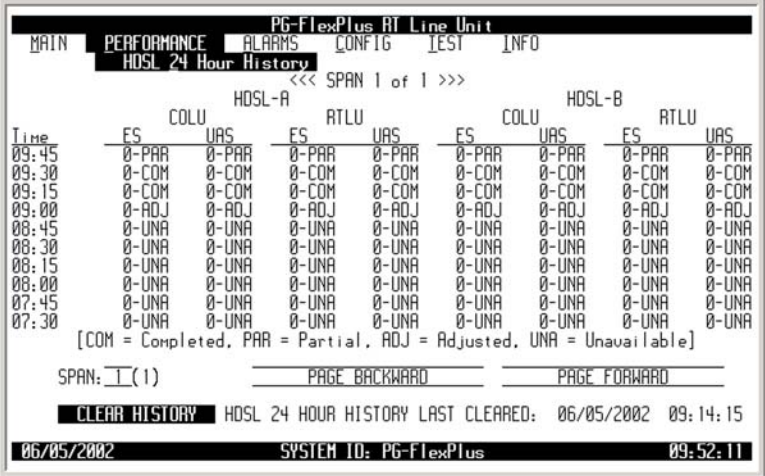
Step	Action																																																																																																																																			
1	<p>At the Main Menu screen, select PERFORMANCE. Press ↓ to choose HDSL 24 Hour History. The following screen appears.</p>  <p>The screenshot shows a terminal window with the following menu options: MAIN, PERFORMANCE, ALARMS, CONFIG, TEST, INFO. Under PERFORMANCE, the options are: HDSL Summary, HDSL 24 Hour History (highlighted), HDSL 2 Day History, ISDN Summary, and ISDN 7 Hr. History. The status bar at the bottom shows the date 06/05/2002, SYSTEM ID: PG-FlexPlus, and time 09:51:29.</p>																																																																																																																																			
2	<p>Press ENTER. The following screen appears.</p>  <p>The screenshot shows a data table for HDSL performance history. The title is 'HDSL 24 Hour History' with '<<< SPAN 1 of 1 >>>'. The table has columns for Time, COLU, HDSL-A, ATLU, HDSL-B, and ATLU. Each of these columns is further divided into ES and UAS. The data rows show status codes like 0-PAR, 0-COM, 0-ADJ, and 0-UNA for each interval. A legend at the bottom explains the codes: [COM = Completed, PAR = Partial, ADJ = Adjusted, UNA = Unavailable]. Navigation options include PAGE BACKWARD, PAGE FORWARD, and CLEAR HISTORY. The status bar shows the date 06/05/2002, SYSTEM ID: PG-FlexPlus, and time 09:52:11.</p> <table border="1"> <thead> <tr> <th rowspan="2">Time</th> <th colspan="2">COLU</th> <th colspan="2">HDSL-A</th> <th colspan="2">ATLU</th> <th colspan="2">HDSL-B</th> <th colspan="2">ATLU</th> </tr> <tr> <th>ES</th> <th>UAS</th> <th>ES</th> <th>UAS</th> <th>ES</th> <th>UAS</th> <th>ES</th> <th>UAS</th> <th>ES</th> <th>UAS</th> </tr> </thead> <tbody> <tr><td>09:45</td><td>0-PAR</td><td>0-PAR</td><td>0-PAR</td><td>0-PAR</td><td>0-PAR</td><td>0-PAR</td><td>0-PAR</td><td>0-PAR</td><td>0-PAR</td><td>0-PAR</td></tr> <tr><td>09:30</td><td>0-COM</td><td>0-COM</td><td>0-COM</td><td>0-COM</td><td>0-COM</td><td>0-COM</td><td>0-COM</td><td>0-COM</td><td>0-COM</td><td>0-COM</td></tr> <tr><td>09:15</td><td>0-COM</td><td>0-COM</td><td>0-COM</td><td>0-COM</td><td>0-COM</td><td>0-COM</td><td>0-COM</td><td>0-COM</td><td>0-COM</td><td>0-COM</td></tr> <tr><td>09:00</td><td>0-ADJ</td><td>0-ADJ</td><td>0-ADJ</td><td>0-ADJ</td><td>0-ADJ</td><td>0-ADJ</td><td>0-ADJ</td><td>0-ADJ</td><td>0-ADJ</td><td>0-ADJ</td></tr> <tr><td>08:45</td><td>0-UNA</td><td>0-UNA</td><td>0-UNA</td><td>0-UNA</td><td>0-UNA</td><td>0-UNA</td><td>0-UNA</td><td>0-UNA</td><td>0-UNA</td><td>0-UNA</td></tr> <tr><td>08:30</td><td>0-UNA</td><td>0-UNA</td><td>0-UNA</td><td>0-UNA</td><td>0-UNA</td><td>0-UNA</td><td>0-UNA</td><td>0-UNA</td><td>0-UNA</td><td>0-UNA</td></tr> <tr><td>08:15</td><td>0-UNA</td><td>0-UNA</td><td>0-UNA</td><td>0-UNA</td><td>0-UNA</td><td>0-UNA</td><td>0-UNA</td><td>0-UNA</td><td>0-UNA</td><td>0-UNA</td></tr> <tr><td>08:00</td><td>0-UNA</td><td>0-UNA</td><td>0-UNA</td><td>0-UNA</td><td>0-UNA</td><td>0-UNA</td><td>0-UNA</td><td>0-UNA</td><td>0-UNA</td><td>0-UNA</td></tr> <tr><td>07:45</td><td>0-UNA</td><td>0-UNA</td><td>0-UNA</td><td>0-UNA</td><td>0-UNA</td><td>0-UNA</td><td>0-UNA</td><td>0-UNA</td><td>0-UNA</td><td>0-UNA</td></tr> <tr><td>07:30</td><td>0-UNA</td><td>0-UNA</td><td>0-UNA</td><td>0-UNA</td><td>0-UNA</td><td>0-UNA</td><td>0-UNA</td><td>0-UNA</td><td>0-UNA</td><td>0-UNA</td></tr> </tbody> </table> <p>In the Time field, 15-minute interval information is displayed. For example, the time interval marked 9:45 contains the information for 9:30 AM to 9:45 AM. The status of the count is shown as:</p> <ul style="list-style-type: none"> • ADJ (Adjusted): Time or date has been changed or the history cleared on the system during this interval • COM (Complete): Data is saved in the history register for this interval • PAR (Partial): Data is being collected for this interval • UNA (Unavailable): Data has not been collected for this interval or has been reset during a previous time interval 	Time	COLU		HDSL-A		ATLU		HDSL-B		ATLU		ES	UAS	ES	UAS	ES	UAS	ES	UAS	ES	UAS	09:45	0-PAR	0-PAR	0-PAR	0-PAR	0-PAR	0-PAR	0-PAR	0-PAR	0-PAR	0-PAR	09:30	0-COM	0-COM	0-COM	0-COM	0-COM	0-COM	0-COM	0-COM	0-COM	0-COM	09:15	0-COM	0-COM	0-COM	0-COM	0-COM	0-COM	0-COM	0-COM	0-COM	0-COM	09:00	0-ADJ	0-ADJ	0-ADJ	0-ADJ	0-ADJ	0-ADJ	0-ADJ	0-ADJ	0-ADJ	0-ADJ	08:45	0-UNA	0-UNA	0-UNA	0-UNA	0-UNA	0-UNA	0-UNA	0-UNA	0-UNA	0-UNA	08:30	0-UNA	0-UNA	0-UNA	0-UNA	0-UNA	0-UNA	0-UNA	0-UNA	0-UNA	0-UNA	08:15	0-UNA	0-UNA	0-UNA	0-UNA	0-UNA	0-UNA	0-UNA	0-UNA	0-UNA	0-UNA	08:00	0-UNA	0-UNA	0-UNA	0-UNA	0-UNA	0-UNA	0-UNA	0-UNA	0-UNA	0-UNA	07:45	0-UNA	0-UNA	0-UNA	0-UNA	0-UNA	0-UNA	0-UNA	0-UNA	0-UNA	0-UNA	07:30	0-UNA	0-UNA	0-UNA	0-UNA	0-UNA	0-UNA	0-UNA	0-UNA	0-UNA	0-UNA
Time	COLU		HDSL-A		ATLU		HDSL-B		ATLU																																																																																																																											
	ES	UAS	ES	UAS	ES	UAS	ES	UAS	ES	UAS																																																																																																																										
09:45	0-PAR	0-PAR	0-PAR	0-PAR	0-PAR	0-PAR	0-PAR	0-PAR	0-PAR	0-PAR																																																																																																																										
09:30	0-COM	0-COM	0-COM	0-COM	0-COM	0-COM	0-COM	0-COM	0-COM	0-COM																																																																																																																										
09:15	0-COM	0-COM	0-COM	0-COM	0-COM	0-COM	0-COM	0-COM	0-COM	0-COM																																																																																																																										
09:00	0-ADJ	0-ADJ	0-ADJ	0-ADJ	0-ADJ	0-ADJ	0-ADJ	0-ADJ	0-ADJ	0-ADJ																																																																																																																										
08:45	0-UNA	0-UNA	0-UNA	0-UNA	0-UNA	0-UNA	0-UNA	0-UNA	0-UNA	0-UNA																																																																																																																										
08:30	0-UNA	0-UNA	0-UNA	0-UNA	0-UNA	0-UNA	0-UNA	0-UNA	0-UNA	0-UNA																																																																																																																										
08:15	0-UNA	0-UNA	0-UNA	0-UNA	0-UNA	0-UNA	0-UNA	0-UNA	0-UNA	0-UNA																																																																																																																										
08:00	0-UNA	0-UNA	0-UNA	0-UNA	0-UNA	0-UNA	0-UNA	0-UNA	0-UNA	0-UNA																																																																																																																										
07:45	0-UNA	0-UNA	0-UNA	0-UNA	0-UNA	0-UNA	0-UNA	0-UNA	0-UNA	0-UNA																																																																																																																										
07:30	0-UNA	0-UNA	0-UNA	0-UNA	0-UNA	0-UNA	0-UNA	0-UNA	0-UNA	0-UNA																																																																																																																										

PERFORMANCE — HDSL 24 Hour History (Continued)

Step	Action
3	<p>The following actions can be taken:</p> <ol style="list-style-type: none"> To scroll through all 15-minute intervals, select the PAGE FORWARD or PAGE BACKWARD button and press ENTER. To view additional spans, select the SPAN field and press SPACEBAR to toggle to the other spans, then press ENTER. To clear the HDSL 24 Hour History, select the CLEAR HISTORY button and press ENTER. From the HDSL 24 HOUR HISTORY WILL BE CLEARED. CONTINUE (Y/N)? prompt, the following actions can be taken: <ul style="list-style-type: none"> To clear the HDSL 24 Hour History, press Y. The following events occur: <ol style="list-style-type: none"> all HDSL 24 hour history 15-minute interval registers are set to zero and labeled UNA current interval is labeled as ADJ time and date that the registers were last cleared are updated <div data-bbox="479 772 1242 1249" style="border: 1px solid black; padding: 5px; margin: 10px 0;"> <pre> PG-FlexPlus RT Line Unit MAIN PERFORMANCE ALARMS CONFIG TEST INFO HDSL 24 Hour History <<< SPAN 1 of 1 >>> HDSL-A HDSL-B Time ES COLU UAS ES ATLU UAS ES COLU UAS ES ATLU UAS 09:45 0-PAR 0-PAR 0-PAR 0-PAR 0-PAR 0-PAR 0-PAR 0-PAR 0-PAR 0-PAR 09:30 0-COM 0-COM 0-COM 0-COM 0-COM 0-COM 0-COM 0-COM 0-COM 0-COM 09:15 0-COM 0-COM 0-COM 0-COM 0-COM 0-COM 0-COM 0-COM 0-COM 0-COM 09:00 0-ADJ 0-ADJ 0-ADJ 0-ADJ 0-ADJ 0-ADJ 0-ADJ 0-ADJ 0-ADJ 0-ADJ 08:45 0-UNA 0-UNA 0-UNA 0-UNA 0-UNA 0-UNA 0-UNA 0-UNA 0-UNA 0-UNA 08:30 0-UNA 0-UNA 0-UNA 0-UNA 0-UNA 0-UNA 0-UNA 0-UNA 0-UNA 0-UNA 08:15 0-UNA 0-UNA 0-UNA 0-UNA 0-UNA 0-UNA 0-UNA 0-UNA 0-UNA 0-UNA 08:00 0-UNA 0-UNA 0-UNA 0-UNA 0-UNA 0-UNA 0-UNA 0-UNA 0-UNA 0-UNA 07:45 0-UNA 0-UNA 0-UNA 0-UNA 0-UNA 0-UNA 0-UNA 0-UNA 0-UNA 0-UNA 07:30 0-UNA 0-UNA 0-UNA 0-UNA 0-UNA 0-UNA 0-UNA 0-UNA 0-UNA 0-UNA [COM = Completed, PAR = Partial, ADJ = Adjusted, UNA = Unavailable] SPAN: 1(1) PAGE BACKWARD PAGE FORWARD HDSL 24 HOUR HISTORY WILL BE CLEARED. CONTINUE (Y/N)? CLEAR HISTORY HDSL 24 HOUR HISTORY LAST CLEARED: 06/05/2002 09:14:15 06/05/2002 SYSTEM ID: PG-FlexPlus 09:52:39 </pre> </div> <div data-bbox="479 1281 1242 1753" style="border: 1px solid black; padding: 5px; margin: 10px 0;"> <pre> PG-FlexPlus RT Line Unit MAIN PERFORMANCE ALARMS CONFIG TEST INFO HDSL 24 Hour History <<< SPAN 1 of 1 >>> HDSL-A HDSL-B Time ES COLU UAS ES ATLU UAS ES COLU UAS ES ATLU UAS 09:45 0-ADJ 0-ADJ 0-ADJ 0-ADJ 0-ADJ 0-ADJ 0-ADJ 0-ADJ 0-ADJ 0-ADJ 09:30 0-UNA 0-UNA 0-UNA 0-UNA 0-UNA 0-UNA 0-UNA 0-UNA 0-UNA 0-UNA 09:15 0-UNA 0-UNA 0-UNA 0-UNA 0-UNA 0-UNA 0-UNA 0-UNA 0-UNA 0-UNA 09:00 0-UNA 0-UNA 0-UNA 0-UNA 0-UNA 0-UNA 0-UNA 0-UNA 0-UNA 0-UNA 08:45 0-UNA 0-UNA 0-UNA 0-UNA 0-UNA 0-UNA 0-UNA 0-UNA 0-UNA 0-UNA 08:30 0-UNA 0-UNA 0-UNA 0-UNA 0-UNA 0-UNA 0-UNA 0-UNA 0-UNA 0-UNA 08:15 0-UNA 0-UNA 0-UNA 0-UNA 0-UNA 0-UNA 0-UNA 0-UNA 0-UNA 0-UNA 08:00 0-UNA 0-UNA 0-UNA 0-UNA 0-UNA 0-UNA 0-UNA 0-UNA 0-UNA 0-UNA 07:45 0-UNA 0-UNA 0-UNA 0-UNA 0-UNA 0-UNA 0-UNA 0-UNA 0-UNA 0-UNA 07:30 0-UNA 0-UNA 0-UNA 0-UNA 0-UNA 0-UNA 0-UNA 0-UNA 0-UNA 0-UNA [COM = Completed, PAR = Partial, ADJ = Adjusted, UNA = Unavailable] SPAN: 1(1) PAGE BACKWARD PAGE FORWARD CLEAR HISTORY HDSL 24 HOUR HISTORY LAST CLEARED: 06/05/2002 09:53:08 06/05/2002 SYSTEM ID: PG-FlexPlus 09:53:11 </pre> </div>
	<p> If there is an active 15-minute ES or UAS alarm, this alarm becomes inactive when the 24-hour performance history is cleared and reactivates once the threshold has been crossed.</p> <ul style="list-style-type: none"> To retain the existing HDSL 24 Hour History, press N.

PERFORMANCE — HDSL 24 Hour History (Continued)

Step	Action
4	Press ESC . The Main Menu screen reappears.

PERFORMANCE — HDSL 7 Day History

This screen displays the last seven days of performance history, plus the current day's accumulated performance history in 24-hour intervals. The performance history data information displayed includes ES counts, UAS counts, and the status of the counts.

PERFORMANCE — HDSL 7 Day History

Step	Action
1	<p>At the Main Menu screen, select PERFORMANCE. Press ↓ to choose HDSL 7 Day History. The following screen appears.</p> 

PERFORMANCE — HDSL 7 Day History (Continued)

Step	Action
2	<p>Press ENTER. The following screen appears.</p> <div data-bbox="479 388 1242 871" style="border: 1px solid black; padding: 5px;"> <pre> PG-FlexPlus RT Line Unit MAIN PERFORMANCE ALARMS CONFIG TEST INFO HDSL 7 Day History <<< SPAN 1 of 1 >>> HDSL-A HDSL-B Date ES COLU UAS ES ATLU UAS ES COLU UAS ES ATLU UAS 06/05 0-ADJ 0-ADJ 0-ADJ 0-ADJ 0-ADJ 0-ADJ 0-ADJ 0-ADJ 0-ADJ 06/04 0-UNA 0-UNA 0-UNA 0-UNA 0-UNA 0-UNA 0-UNA 0-UNA 0-UNA 06/03 0-UNA 0-UNA 0-UNA 0-UNA 0-UNA 0-UNA 0-UNA 0-UNA 0-UNA 06/02 0-UNA 0-UNA 0-UNA 0-UNA 0-UNA 0-UNA 0-UNA 0-UNA 0-UNA 06/01 0-UNA 0-UNA 0-UNA 0-UNA 0-UNA 0-UNA 0-UNA 0-UNA 0-UNA 05/31 0-UNA 0-UNA 0-UNA 0-UNA 0-UNA 0-UNA 0-UNA 0-UNA 0-UNA 05/30 0-UNA 0-UNA 0-UNA 0-UNA 0-UNA 0-UNA 0-UNA 0-UNA 0-UNA 05/29 0-UNA 0-UNA 0-UNA 0-UNA 0-UNA 0-UNA 0-UNA 0-UNA 0-UNA [COM = Completed, PAR = Partial, ADJ = Adjusted, UNA = Unavailable] SPAN: 1(1) CLEAR HISTORY FOR ALL SPANS HDSL 7 DAY HISTORY LAST CLEARED: 06/05/2002 09:16:33 06/05/2002 SYSTEM ID: PG-FlexPlus 09:54:33 </pre> </div> <p>The current day performance information shows the performance since the previous midnight. At midnight of every day, the current day performance history is moved to the previous day's history and the current day performance information is cleared. The status of the count is shown as:</p> <ul style="list-style-type: none"> • ADJ (Adjusted): Time or date has been changed or the history cleared on the system during this interval • COM (Complete): Data is saved in the history register for this interval • PAR (Partial): Data is being collected for this interval • UNA (Unavailable): Data has not been collected for this interval or has been reset during a previous time interval

PERFORMANCE — HDSL 7 Day History (Continued)

Step	Action
3	<p>The following actions can be taken:</p> <ol style="list-style-type: none"> To view additional spans, select the SPAN field and press SPACEBAR to toggle to the other spans, then press ENTER. To clear the HDSL 7 Day History, select the CLEAR HISTORY FOR ALL SPANS button and press ENTER. From the HDSL 7 DAY HISTORY WILL BE CLEARED. CONTINUE (Y/N)? prompt, the following actions can be taken: <ul style="list-style-type: none"> To clear the HDSL 7 Day History, press Y. The following events occur: <ol style="list-style-type: none"> all HDSL 7 day history 24-hour interval registers are set to zero and labeled UNA current interval is labeled as ADJ time and date that the registers were last cleared are updated <div data-bbox="479 703 1242 1186" style="border: 1px solid black; padding: 5px; margin: 10px 0;"> <pre> PG-FlexPlus RT Line Unit MAIN PERFORMANCE ALARMS CONFIG TEST INFO HDSL 7 Day History <<< SPAN 1 of 1 >>> HDSL-A HDSL-B Date COLU UAS ES UAS ES UAS ES UAS 06/05 0-ADJ 0-ADJ 0-ADJ 0-ADJ 0-ADJ 0-ADJ 0-ADJ 0-ADJ 06/04 0-UNA 0-UNA 0-UNA 0-UNA 0-UNA 0-UNA 0-UNA 0-UNA 06/03 0-UNA 0-UNA 0-UNA 0-UNA 0-UNA 0-UNA 0-UNA 0-UNA 06/02 0-UNA 0-UNA 0-UNA 0-UNA 0-UNA 0-UNA 0-UNA 0-UNA 06/01 0-UNA 0-UNA 0-UNA 0-UNA 0-UNA 0-UNA 0-UNA 0-UNA 05/31 0-UNA 0-UNA 0-UNA 0-UNA 0-UNA 0-UNA 0-UNA 0-UNA 05/30 0-UNA 0-UNA 0-UNA 0-UNA 0-UNA 0-UNA 0-UNA 0-UNA 05/29 0-UNA 0-UNA 0-UNA 0-UNA 0-UNA 0-UNA 0-UNA 0-UNA [COM = Completed, PAR = Partial, ADJ = Adjusted, UNA = Unavailable] SPAN: 1(1) CLEAR HISTORY FOR ALL SPANS HDSL 7 DAY HISTORY LAST CLEARED: 06/05/2002 09:16:33 HDSL 7 DAY HISTORY WILL BE CLEARED. CONTINUE (Y/N)? 06/05/2002 SYSTEM ID: PG-FlexPlus 09:54:59 </pre> </div> <div data-bbox="479 1207 1242 1690" style="border: 1px solid black; padding: 5px; margin: 10px 0;"> <pre> PG-FlexPlus RT Line Unit MAIN PERFORMANCE ALARMS CONFIG TEST INFO HDSL 7 Day History <<< SPAN 1 of 1 >>> HDSL-A HDSL-B Date COLU UAS ES UAS ES UAS ES UAS 06/05 0-ADJ 0-ADJ 0-ADJ 0-ADJ 0-ADJ 0-ADJ 0-ADJ 0-ADJ 06/04 0-UNA 0-UNA 0-UNA 0-UNA 0-UNA 0-UNA 0-UNA 0-UNA 06/03 0-UNA 0-UNA 0-UNA 0-UNA 0-UNA 0-UNA 0-UNA 0-UNA 06/02 0-UNA 0-UNA 0-UNA 0-UNA 0-UNA 0-UNA 0-UNA 0-UNA 06/01 0-UNA 0-UNA 0-UNA 0-UNA 0-UNA 0-UNA 0-UNA 0-UNA 05/31 0-UNA 0-UNA 0-UNA 0-UNA 0-UNA 0-UNA 0-UNA 0-UNA 05/30 0-UNA 0-UNA 0-UNA 0-UNA 0-UNA 0-UNA 0-UNA 0-UNA 05/29 0-UNA 0-UNA 0-UNA 0-UNA 0-UNA 0-UNA 0-UNA 0-UNA [COM = Completed, PAR = Partial, ADJ = Adjusted, UNA = Unavailable] SPAN: 1(1) CLEAR HISTORY FOR ALL SPANS HDSL 7 DAY HISTORY LAST CLEARED: 06/05/2002 09:55:30 06/05/2002 SYSTEM ID: PG-FlexPlus 09:55:33 </pre> </div> <p>If there is an active 1-day ES or UAS alarm, this alarm becomes inactive when the 24-hour performance history is cleared and reactivates once the threshold has been crossed.</p> <ul style="list-style-type: none"> To retain the existing HDSL 7 Day History, press N.
4	Press ESC . The Main Menu screen reappears.

PERFORMANCE — ISDN Summary

This screen allows you to select an ISDN channel and view the ISDN performance data. The displayed information includes:

- ES and SES counts for the current hour, the previous hour, the current day and the previous day
- Bit Error (BE) counts for the current hour and previous hour

PERFORMANCE — ISDN Summary

Step	Action
1	<p>At the Main Menu screen, select PERFORMANCE. Press ↓ to choose ISDN Summary. The following screen appears.</p> 

PERFORMANCE — ISDN Summary (Continued)

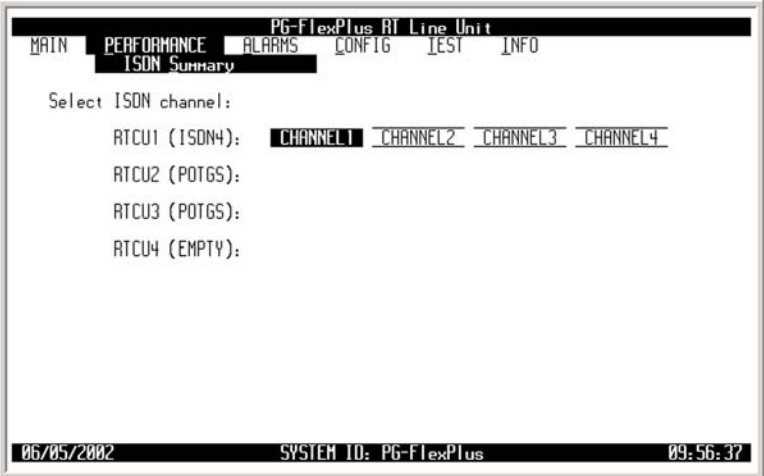
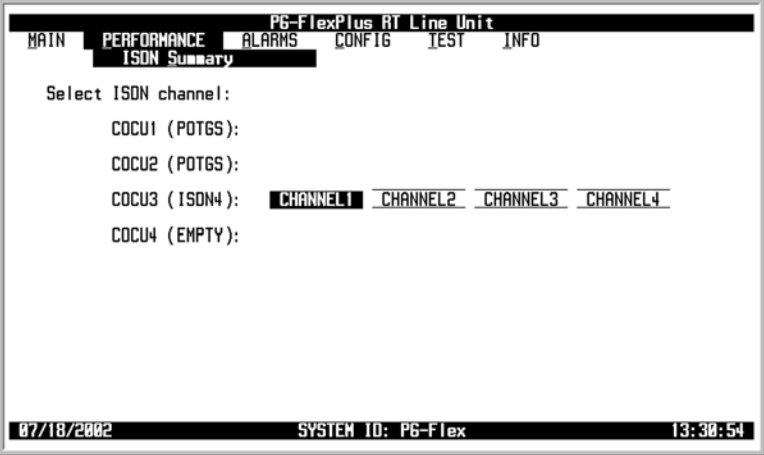
Step	Action
2	<p>Integrated: Press ENTER. The following screen appears.</p>  <p>To view the ISDN performance data, select the ISDN channel, then press ENTER.</p> <p>Universal: Press ENTER. The following screen appears.</p>  <p>To view the ISDN performance data, select the ISDN channel, then press ENTER.</p>

PERFORMANCE — ISDN Summary (Continued)

Step	Action
3	<p>The following actions can be taken:</p> <ol style="list-style-type: none"> To clear the current and 7 hour history ISDN PM counts for this channel, press Y from the CLEAR ISDN PM COUNTS FOR THIS CHANNEL (Y)? prompt. To verify you want to clear the current and 7 hour history ISDN PM counts for this channel, press Y from the ISDN PM COUNTS WILL BE CLEARED. CONTINUE (Y/N)? prompt. The following event occurs: <ul style="list-style-type: none"> all ISDN PM counts are set to zero To retain the existing ISDN performance data, press N.
4	<p>Press ESC. The Main Menu screen reappears.</p>

```

PG-FlexPlus RT Line Unit
MAIN PERFORMANCE ALARMS CONFIG TEST INFO
ISDN Summary

PM TYPE: Interim Path      CU: 1      CH: 1

COLU CURRENT      COLU PREVIOUS      ATLU CURRENT      ATLU PREVIOUS
Customer/Network  Customer/Network    Customer/Network  Customer/Network
HOURLY ES :      N/A / N/A      N/A / N/A      0 / 0      0 / 0
HOURLY SES :     N/A / N/A      N/A / N/A      0 / 0      0 / 0
HOURLY BE :      N/A / N/A      N/A / N/A      0 / 0      0 / 0
DAILY ES :       N/A / N/A      N/A / N/A      0 / 0      0 / 0
DAILY SES :     N/A / N/A      N/A / N/A      0 / 0      0 / 0

CLEAR ISDN PM COUNTS FOR THIS CHANNEL (Y)? █
(Y WILL CLEAR CURRENT AND 7 HOUR HISTORY ISDN
PM COUNTS FOR THIS CHANNEL)

06/05/2002          SYSTEM ID: PG-FlexPlus          09:57:05
    
```

```

PG-FlexPlus RT Line Unit
MAIN PERFORMANCE ALARMS CONFIG TEST INFO
ISDN Summary

PM TYPE: Interim Path      CU: 1      CH: 1

COLU CURRENT      COLU PREVIOUS      ATLU CURRENT      ATLU PREVIOUS
Customer/Network  Customer/Network    Customer/Network  Customer/Network
HOURLY ES :      N/A / N/A      N/A / N/A      0 / 0      0 / 0
HOURLY SES :     N/A / N/A      N/A / N/A      0 / 0      0 / 0
HOURLY BE :      N/A / N/A      N/A / N/A      0 / 0      0 / 0
DAILY ES :       N/A / N/A      N/A / N/A      0 / 0      0 / 0
DAILY SES :     N/A / N/A      N/A / N/A      0 / 0      0 / 0

ISDN PM COUNTS WILL BE CLEARED. CONTINUE (Y/N)? █
(Y WILL CLEAR CURRENT AND 7 HOUR HISTORY ISDN
PM COUNTS FOR THIS CHANNEL)

06/05/2002          SYSTEM ID: PG-FlexPlus          09:57:33
    
```



If there are alarms associated with the performance counts, those alarms are reset when the ISDN performance data is cleared.



Errors in the Customer column indicate errors in transmission from the Network (ISDN switch) to the Customer. Errors in the Network column indicate errors in transmission from the Customer to the Network.

PERFORMANCE — ISDN 7 Hour History

This screen allows you to select an ISDN channel and view the ISDN 7 Hour ES history information.

PERFORMANCE — ISDN 7 Hour History

Step	Action
1	<p>At the Main Menu screen, select PERFORMANCE. Press ↓ to choose ISDN 7 Hr. History. The following screen appears.</p>  <p>The screenshot shows a terminal window with the following content:</p> <pre> PG-FlexPlus RT Line Unit MAIN PERFORMANCE ALARMS CONFIG TEST INFO HDSL Summary HDSL 24 Hour History HDSL 7 Day History ISDN Summary ISDN 7 Hr. History </pre> <p>At the bottom of the screen, the status bar displays: 06/05/2002 SYSTEM ID: PG-FlexPlus 09:58:31</p>

PERFORMANCE — ISDN 7 Hour History (Continued)

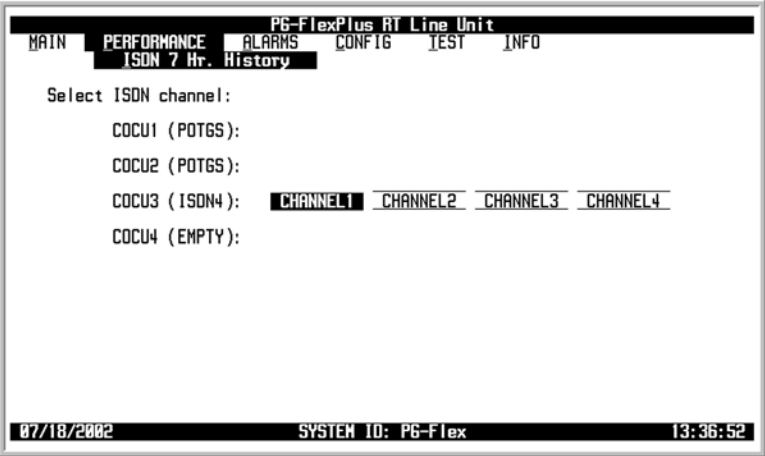
Step	Action
2	<p>Integrated: Press ENTER. The following screen appears..</p>  <pre> PG-FlexPlus RT Line Unit MAIN PERFORMANCE ALARMS CONFIG TEST INFO ISDN 7 Hr. History Select ISDN channel: RTCU1 (ISDN4): CHANNEL1 CHANNEL2 CHANNEL3 CHANNEL4 RTCU2 (POTGS): RTCU3 (POTGS): RTCU4 (EMPTY): 06/05/2002 SYSTEM ID: PG-FlexPlus 09:59:09 </pre> <p>To view ISDN 7 Hour ES history, select an ISDN channel unit, then press ENTER.</p> <p>Universal: Press ENTER. The following screen appears..</p>  <pre> PG-FlexPlus POT Line Unit MAIN PERFORMANCE ALARMS CONFIG TEST INFO ISDN 7 Hr. History Select ISDN channel: COCU1 (POTGS): COCU2 (POTGS): COCU3 (ISDN4): CHANNEL1 CHANNEL2 CHANNEL3 CHANNEL4 COCU4 (EMPTY): 07/18/2002 SYSTEM ID: PG-Flex 13:36:52 </pre> <p>To view ISDN 7 Hour ES history, select an ISDN channel unit, then press ENTER.</p>

PERFORMANCE — ISDN 7 Hour History (Continued)

Step	Action
3	<p>The following actions can be taken:</p> <ol style="list-style-type: none"> To clear the current and 7 hour history counts for this channel, press Y from the CLEAR ISDN PM COUNTS FOR THIS CHANNEL (Y)? prompt. To verify you want the ISDN PM counts to be cleared, press Y from the ISDN PM COUNTS WILL BE CLEARED. CONTINUE (Y/N)? prompt. The following event occurs: <ul style="list-style-type: none"> all ISDN PM counts are set to zero To retain the existing performance data, press N. <div data-bbox="479 611 1239 1087" style="border: 1px solid black; padding: 5px; margin: 10px 0;"> <pre> PG-FlexPlus RT Line Unit MAIN PERFORMANCE ALARMS CONFIG TEST INFO ISDN ? Hr. History ISDN Hourly ES History CU: 1 CH: 1 COLU ATLU Customer/Network Customer/Network Current Hour : N/A / N/A 0 / 0 Previous Hour : N/A / N/A 0 / 0 Previous Hour-1 : N/A / N/A 0 / 0 Previous Hour-2 : N/A / N/A 0 / 0 Previous Hour-3 : N/A / N/A 0 / 0 Previous Hour-4 : N/A / N/A 0 / 0 Previous Hour-5 : N/A / N/A 0 / 0 Previous Hour-6 : N/A / N/A 0 / 0 Previous Hour-7 : N/A / N/A 0 / 0 CLEAR ISDN PM COUNTS FOR THIS CHANNEL (Y)? █ (Y WILL CLEAR CURRENT AND 7 HOUR HISTORY ISDN PM COUNTS FOR THIS CHANNEL) 06/05/2002 SYSTEM ID: PG-FlexPlus 09:59:35 </pre> </div> <div data-bbox="479 1115 1239 1591" style="border: 1px solid black; padding: 5px; margin: 10px 0;"> <pre> PG-FlexPlus RT Line Unit MAIN PERFORMANCE ALARMS CONFIG TEST INFO ISDN ? Hr. History ISDN Hourly ES History CU: 1 CH: 1 COLU ATLU Customer/Network Customer/Network Current Hour : N/A / N/A 0 / 0 Previous Hour : N/A / N/A 0 / 0 Previous Hour-1 : N/A / N/A 0 / 0 Previous Hour-2 : N/A / N/A 0 / 0 Previous Hour-3 : N/A / N/A 0 / 0 Previous Hour-4 : N/A / N/A 0 / 0 Previous Hour-5 : N/A / N/A 0 / 0 Previous Hour-6 : N/A / N/A 0 / 0 Previous Hour-7 : N/A / N/A 0 / 0 ISDN PM COUNTS WILL BE CLEARED. CONTINUE (Y/N)? █ (Y WILL CLEAR CURRENT AND 7 HOUR HISTORY ISDN PM COUNTS FOR THIS CHANNEL) 06/05/2002 SYSTEM ID: PG-FlexPlus 10:00:03 </pre> </div>
4	<p>Press ESC. The Main Menu screen reappears.</p>



If there are alarms associated with the performance counts, those alarms are reset when the ISDN performance data is cleared.



Errors in the Customer column indicate errors in transmission from the Network (ISDN switch) to the Customer. Errors in the Network column indicate errors in transmission from the Customer to the Network.

ALARM MENU OPTIONS

The Alarm Menu provides access to the alarm status and system related alarm events. Refer to [Table 11 on page 45](#) for sub-menu options and descriptions, parameters and valid values.



ISDN menu selections are only present if ISDN is installed the system.



Table 11. Alarm Menu Options

Sub-Menu Options	Sub-Menu Descriptions	Selectable Parameter Options	Valid Values
Alarm Summary	View the active system alarms	All Alarm Histories will be cleared. Continue (Y/N)?	Y or N
COLU System History	View the COLU alarm history	System Alarm History will be cleared. Continue (Y/N)?	Y or N
RTL System History	View the RTL alarm history	System Alarm History will be cleared. Continue (Y/N)?	Y or N
HDSL History	View the HDSL history	<ul style="list-style-type: none"> • Span • HDSL Alarm History will be cleared. Continue (Y/N)? 	<ul style="list-style-type: none"> • 1 (2 or 3 – if doublers are used) • Y or N
ISDN History	View the ISDN history	ISDN Alarm History will be cleared. Continue (Y/N)?	Y or N
CU History	View the channel unit alarm history	CU Alarm History will be cleared. Continue (Y/N)?	Y or N
COLU Faults	View COLU faults detected by the unit		
RTL Faults	View RTL faults detected by the unit		

ALARMS — Alarms Summary

This screen displays the active critical, major, and minor alarms of the system.

ALARMS — Alarms Summary

Step	Action
1	<p>At the Main Menu screen, select ALARMS. Press ↓ to choose Alarms Summary. The following screen appears.</p> <div data-bbox="479 520 1237 993" style="border: 1px solid black; padding: 5px; margin: 10px auto; width: fit-content;"> <pre> PG-FlexPlus AT Line Unit MAIN PERFORMANCE ALARMS CONFIG TEST INFO Alarms Summary SYSTEM HDLSL CU ISON ALARMS ALARMS ALARMS ALARMS COLU ATLU SPAN1 SPAN2 SPAN3 COCU ATCU COLU ATLU CRITICAL : : : : : N/A : N/A : : N/A : : : MAJOR : : : : : N/A : N/A : : N/A : : : MINOR : : : : : N/A : N/A : : N/A : * : : NOT REPORTED : : : * : N/A : N/A : : N/A : : : N/A : : CLEAR ALL ALARM HISTORIES [* = ACTIVE ALARM, N/A = Not Applicable] 06/05/2002 SYSTEM ID: PG-FlexPlus 12:48:05 </pre> </div> <p>The alarm information displayed indicates:</p> <p>Alarm Types:</p> <ul style="list-style-type: none"> • CRITICAL Critical alarm is present • MAJOR Major alarm is present • MINOR Minor alarm is present • NOT ALARMED Condition is active, but has no severity • NOT REPORTED Condition not reported by system <p>Alarm States:</p> <ul style="list-style-type: none"> • * Designates active alarm

ALARMS — Alarms Summary (Continued)

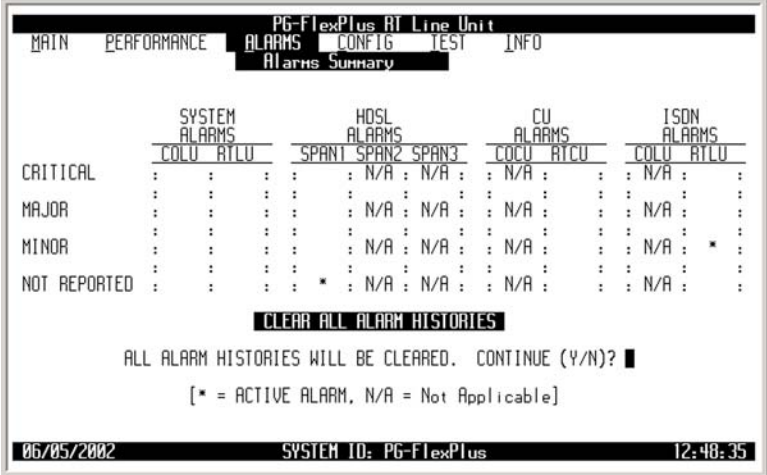
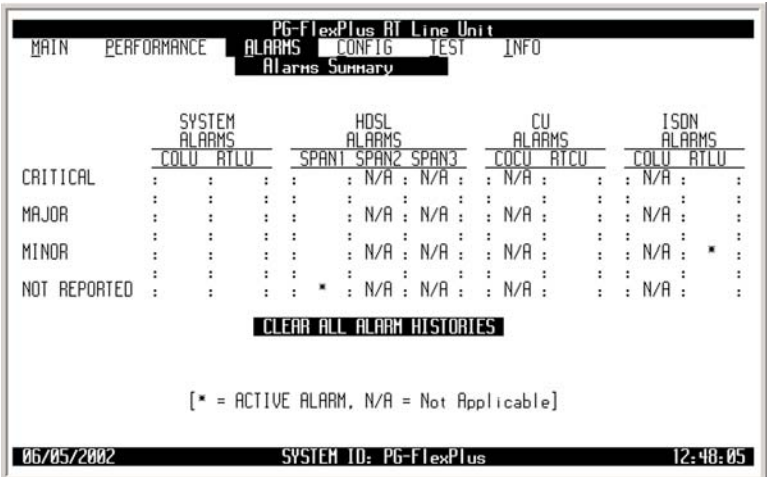
Step	Action
2	<p>Press ENTER. The following screen appears.</p>  <p>To view an alarm, press ← or → to move to the appropriate alarm column:</p> <ul style="list-style-type: none"> • SYSTEM ALARMS – COLU or RTLU • HDSL ALARMS – SPAN1, SPAN 2, or SPAN3 • CU ALARMS – COCU or RTCU • ISDN ALARMS – COLU or RTLU <p>Then press ENTER.</p>
3	<p>The following actions can be taken:</p> <ol style="list-style-type: none"> To clear the history of all alarms, select the CLEAR ALL ALARM HISTORIES button, then press ENTER. From the HDSL ALARM HISTORIES WILL BE CLEARED. CONTINUE (Y/N)? prompt, the following actions can be taken: To clear the history of all alarms, press Y. The following events occur: <ul style="list-style-type: none"> • all alarm history counts are set to zero • time and date that the registers were last cleared are updated  <ol style="list-style-type: none"> To retain the existing summary of active alarms, press N.



ALARMS — Alarms Summary (Continued)

Step	Action
4	Press ESC . The Main Menu screen reappears.

ALARMS — COLU System History (Integrated)

This screen displays the COLU alarm history (Integrated setup). Information includes a count of the number of times each alarm occurred, the time and date of the first and last occurrence, the provisioned alarm type, and the current status.

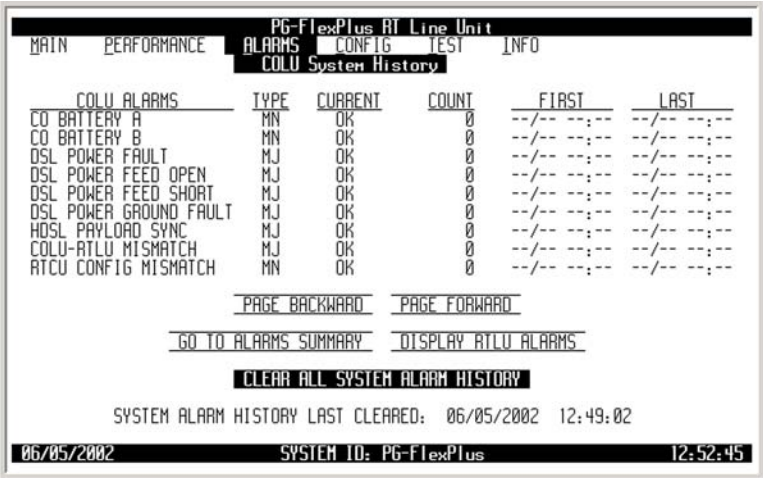
ALARMS — COLU System History (Integrated)

Step	Action
1	<p>At the Main Menu screen, select ALARMS. Press ↓ to choose COLU System History. The following screen appears.</p>  <p>The screenshot shows a terminal-style interface with a menu. At the top, it says 'PG-FlexPlus RT Line Unit'. Below that are several menu options: MAIN, PERFORMANCE, ALARMS (highlighted), CONFIG, TEST, and INFO. A sub-menu is displayed under ALARMS, listing: Alarms Summary, COLU System History (highlighted), ATLU System History, HDLS History, ISDN History, CU History, COLU Faults, and ATLU Faults. At the bottom of the screen, it shows the date '06/05/2002', 'SYSTEM ID: PG-FlexPlus', and the time '12:50:03'.</p>
2	<p>Press ENTER. The following screen appears.</p>  <p>The screenshot shows the 'COLU System History' screen. At the top, it says 'PG-FlexPlus RT Line Unit'. Below that are menu options: MAIN, PERFORMANCE, ALARMS (highlighted), CONFIG, TEST, and INFO. The main content is a table with the following columns: COLU ALARMS, TYPE, CURRENT, COUNT, FIRST, and LAST. The table lists several alarm types, all with a current status of 'OK' and a count of 0. Below the table are several menu options: PAGE BACKWARD, PAGE FORWARD, GO TO ALARMS SUMMARY, DISPLAY ATLU ALARMS, and CLEAR ALL SYSTEM ALARM HISTORY (highlighted). At the bottom, it shows 'SYSTEM ALARM HISTORY LAST CLEARED: 06/05/2002 12:49:02'. The footer shows the date '06/05/2002', 'SYSTEM ID: PG-FlexPlus', and the time '12:52:45'.</p> <p> The status <i>OK</i> displays in the <i>Current</i> column when the alarm is not present. The status <i>Active</i> displays when an alarm is present (see Table 16 on page 83 for COLU Alarms - Integrated). A description of the Alarm types reported is provided in Table 15 on page 82.</p>

ALARMS — COLU System History (Integrated) (Continued)

Step	Action																																																																																																																								
3	<p>The following actions can be taken:</p> <ol style="list-style-type: none"> To scroll through the COLU system alarm history, select the PAGE FORWARD or PAGE BACKWARD button, then press ENTER. To view a summary of all active alarms, select the GO TO ALARMS SUMMARY button, then press ENTER. To view the RTLU alarm information, select the DISPLAY RTLU ALARMS button, then press ENTER. To clear the COLU alarm history, select the CLEAR ALL SYSTEM ALARM HISTORY button, then press ENTER. From the SYSTEM ALARM HISTORY WILL BE CLEARED. CONTINUE (Y/N)? prompt, the following actions can be taken: <ul style="list-style-type: none"> To clear the COLU alarm history, press Y. The following events occur: <ol style="list-style-type: none"> COLU alarm history counts are set to zero time and date that the registers were last cleared are updated 																																																																																																																								
	<div style="text-align: center;">  <p>PG-FlexPlus AT Line Unit MAIN PERFORMANCE ALARMS CONFIG TEST INFO COLU System History</p> <table border="1"> <thead> <tr> <th>COLU ALARMS</th> <th>TYPE</th> <th>CURRENT</th> <th>COUNT</th> <th>FIRST</th> <th>LAST</th> </tr> </thead> <tbody> <tr><td>CO BATTERY A</td><td>MN</td><td>OK</td><td>0</td><td>--/-- --:--</td><td>--/-- --:--</td></tr> <tr><td>CO BATTERY B</td><td>MN</td><td>OK</td><td>0</td><td>--/-- --:--</td><td>--/-- --:--</td></tr> <tr><td>DSL POWER FAULT</td><td>MJ</td><td>OK</td><td>0</td><td>--/-- --:--</td><td>--/-- --:--</td></tr> <tr><td>DSL POWER FEED OPEN</td><td>MJ</td><td>OK</td><td>0</td><td>--/-- --:--</td><td>--/-- --:--</td></tr> <tr><td>DSL POWER FEED SHORT</td><td>MJ</td><td>OK</td><td>0</td><td>--/-- --:--</td><td>--/-- --:--</td></tr> <tr><td>DSL POWER GROUND FAULT</td><td>MJ</td><td>OK</td><td>0</td><td>--/-- --:--</td><td>--/-- --:--</td></tr> <tr><td>HDSL PAYLOAD SYNC</td><td>MJ</td><td>OK</td><td>0</td><td>--/-- --:--</td><td>--/-- --:--</td></tr> <tr><td>COLU-RTLU MISMATCH</td><td>MJ</td><td>OK</td><td>0</td><td>--/-- --:--</td><td>--/-- --:--</td></tr> <tr><td>RTCU CONFIG MISMATCH</td><td>MN</td><td>OK</td><td>0</td><td>--/-- --:--</td><td>--/-- --:--</td></tr> </tbody> </table> <p>PAGE BACKWARD PAGE FORWARD GO TO ALARMS SUMMARY DISPLAY RTLU ALARMS CLEAR ALL SYSTEM ALARM HISTORY SYSTEM ALARM HISTORY WILL BE CLEARED. CONTINUE (Y/N)? SYSTEM ALARM HISTORY LAST CLEARED: 06/05/2002 12:49:02 06/05/2002 SYSTEM ID: PG-FlexPlus 12:53:15</p> </div> <div style="text-align: center;">  <p>PG-FlexPlus AT Line Unit MAIN PERFORMANCE ALARMS CONFIG TEST INFO COLU System History</p> <table border="1"> <thead> <tr> <th>COLU ALARMS</th> <th>TYPE</th> <th>CURRENT</th> <th>COUNT</th> <th>FIRST</th> <th>LAST</th> </tr> </thead> <tbody> <tr><td>CO BATTERY A</td><td>MN</td><td>OK</td><td>0</td><td>--/-- --:--</td><td>--/-- --:--</td></tr> <tr><td>CO BATTERY B</td><td>MN</td><td>OK</td><td>0</td><td>--/-- --:--</td><td>--/-- --:--</td></tr> <tr><td>DSL POWER FAULT</td><td>MJ</td><td>OK</td><td>0</td><td>--/-- --:--</td><td>--/-- --:--</td></tr> <tr><td>DSL POWER FEED OPEN</td><td>MJ</td><td>OK</td><td>0</td><td>--/-- --:--</td><td>--/-- --:--</td></tr> <tr><td>DSL POWER FEED SHORT</td><td>MJ</td><td>OK</td><td>0</td><td>--/-- --:--</td><td>--/-- --:--</td></tr> <tr><td>DSL POWER GROUND FAULT</td><td>MJ</td><td>OK</td><td>0</td><td>--/-- --:--</td><td>--/-- --:--</td></tr> <tr><td>HDSL PAYLOAD SYNC</td><td>MJ</td><td>OK</td><td>0</td><td>--/-- --:--</td><td>--/-- --:--</td></tr> <tr><td>COLU-RTLU MISMATCH</td><td>MJ</td><td>OK</td><td>0</td><td>--/-- --:--</td><td>--/-- --:--</td></tr> <tr><td>RTCU CONFIG MISMATCH</td><td>MN</td><td>OK</td><td>0</td><td>--/-- --:--</td><td>--/-- --:--</td></tr> </tbody> </table> <p>PAGE BACKWARD PAGE FORWARD GO TO ALARMS SUMMARY DISPLAY RTLU ALARMS CLEAR ALL SYSTEM ALARM HISTORY SYSTEM ALARM HISTORY LAST CLEARED: 06/05/2002 12:53:42 06/05/2002 SYSTEM ID: PG-FlexPlus 12:53:45</p> </div> <p>  Clearing the alarm history does not clear any alarm that is currently active in the system.  If there is an active alarm, the count is set to 1 and the value in the LAST date and time field is set to the FIRST date and time field. <ul style="list-style-type: none"> To retain the existing COLU alarm history, press N. </p>	COLU ALARMS	TYPE	CURRENT	COUNT	FIRST	LAST	CO BATTERY A	MN	OK	0	--/-- --:--	--/-- --:--	CO BATTERY B	MN	OK	0	--/-- --:--	--/-- --:--	DSL POWER FAULT	MJ	OK	0	--/-- --:--	--/-- --:--	DSL POWER FEED OPEN	MJ	OK	0	--/-- --:--	--/-- --:--	DSL POWER FEED SHORT	MJ	OK	0	--/-- --:--	--/-- --:--	DSL POWER GROUND FAULT	MJ	OK	0	--/-- --:--	--/-- --:--	HDSL PAYLOAD SYNC	MJ	OK	0	--/-- --:--	--/-- --:--	COLU-RTLU MISMATCH	MJ	OK	0	--/-- --:--	--/-- --:--	RTCU CONFIG MISMATCH	MN	OK	0	--/-- --:--	--/-- --:--	COLU ALARMS	TYPE	CURRENT	COUNT	FIRST	LAST	CO BATTERY A	MN	OK	0	--/-- --:--	--/-- --:--	CO BATTERY B	MN	OK	0	--/-- --:--	--/-- --:--	DSL POWER FAULT	MJ	OK	0	--/-- --:--	--/-- --:--	DSL POWER FEED OPEN	MJ	OK	0	--/-- --:--	--/-- --:--	DSL POWER FEED SHORT	MJ	OK	0	--/-- --:--	--/-- --:--	DSL POWER GROUND FAULT	MJ	OK	0	--/-- --:--	--/-- --:--	HDSL PAYLOAD SYNC	MJ	OK	0	--/-- --:--	--/-- --:--	COLU-RTLU MISMATCH	MJ	OK	0	--/-- --:--	--/-- --:--	RTCU CONFIG MISMATCH	MN	OK	0	--/-- --:--	--/-- --:--
COLU ALARMS	TYPE	CURRENT	COUNT	FIRST	LAST																																																																																																																				
CO BATTERY A	MN	OK	0	--/-- --:--	--/-- --:--																																																																																																																				
CO BATTERY B	MN	OK	0	--/-- --:--	--/-- --:--																																																																																																																				
DSL POWER FAULT	MJ	OK	0	--/-- --:--	--/-- --:--																																																																																																																				
DSL POWER FEED OPEN	MJ	OK	0	--/-- --:--	--/-- --:--																																																																																																																				
DSL POWER FEED SHORT	MJ	OK	0	--/-- --:--	--/-- --:--																																																																																																																				
DSL POWER GROUND FAULT	MJ	OK	0	--/-- --:--	--/-- --:--																																																																																																																				
HDSL PAYLOAD SYNC	MJ	OK	0	--/-- --:--	--/-- --:--																																																																																																																				
COLU-RTLU MISMATCH	MJ	OK	0	--/-- --:--	--/-- --:--																																																																																																																				
RTCU CONFIG MISMATCH	MN	OK	0	--/-- --:--	--/-- --:--																																																																																																																				
COLU ALARMS	TYPE	CURRENT	COUNT	FIRST	LAST																																																																																																																				
CO BATTERY A	MN	OK	0	--/-- --:--	--/-- --:--																																																																																																																				
CO BATTERY B	MN	OK	0	--/-- --:--	--/-- --:--																																																																																																																				
DSL POWER FAULT	MJ	OK	0	--/-- --:--	--/-- --:--																																																																																																																				
DSL POWER FEED OPEN	MJ	OK	0	--/-- --:--	--/-- --:--																																																																																																																				
DSL POWER FEED SHORT	MJ	OK	0	--/-- --:--	--/-- --:--																																																																																																																				
DSL POWER GROUND FAULT	MJ	OK	0	--/-- --:--	--/-- --:--																																																																																																																				
HDSL PAYLOAD SYNC	MJ	OK	0	--/-- --:--	--/-- --:--																																																																																																																				
COLU-RTLU MISMATCH	MJ	OK	0	--/-- --:--	--/-- --:--																																																																																																																				
RTCU CONFIG MISMATCH	MN	OK	0	--/-- --:--	--/-- --:--																																																																																																																				



ALARMS — COLU System History (Integrated) (Continued)

Step	Action
4	Press ESC . The Main Menu screen reappears.

ALARMS — COLU System History (Universal)

This screen displays the COLU alarm history (Universal setup). Information includes a count of the number of times each alarm occurred, the time and date of the first and last occurrence, the provisioned alarm type, and the current status.

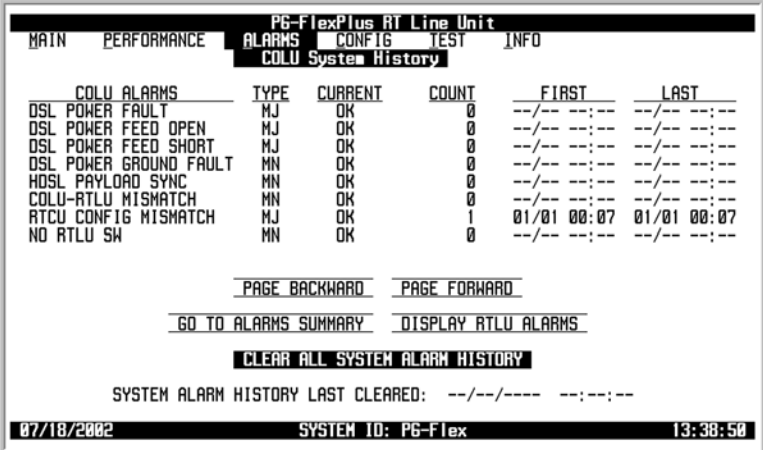
ALARMS — COLU System History (Universal)

Step	Action																																																						
1	<p>At the Main Menu screen, select ALARMS. Press ↓ to choose COLU System History. The following screen appears.</p>  <p>The screenshot shows a terminal-style interface with a top bar 'PG-FlexPlus RT Line Unit'. Below it are menu options: MAIN, PERFORMANCE, ALARMS (highlighted), CONFIG, TEST, INFO. A submenu is open under ALARMS, listing: Alarms Summary, COLU System History (highlighted), ATLU System History, HDLS History, ISDN History, CU History, COLU Faults, and ATLU Faults. At the bottom, it shows the date '06/05/2002', 'SYSTEM ID: PG-FlexPlus', and time '12:50:03'.</p>																																																						
2	<p>Press ENTER. The following screen appears.</p>  <p>The screenshot shows the 'COLU System History' screen. It has a top bar 'PG-FlexPlus RT Line Unit' and menu options: MAIN, PERFORMANCE, ALARMS (highlighted), CONFIG, TEST, INFO. Below is a table:</p> <table border="1"> <thead> <tr> <th>COLU ALARMS</th> <th>TYPE</th> <th>CURRENT</th> <th>COUNT</th> <th>FIRST</th> <th>LAST</th> </tr> </thead> <tbody> <tr> <td>DSL POWER FAULT</td> <td>MJ</td> <td>OK</td> <td>0</td> <td>--/-- --:--</td> <td>--/-- --:--</td> </tr> <tr> <td>DSL POWER FEED OPEN</td> <td>MJ</td> <td>OK</td> <td>0</td> <td>--/-- --:--</td> <td>--/-- --:--</td> </tr> <tr> <td>DSL POWER FEED SHORT</td> <td>MJ</td> <td>OK</td> <td>0</td> <td>--/-- --:--</td> <td>--/-- --:--</td> </tr> <tr> <td>DSL POWER GROUND FAULT</td> <td>MN</td> <td>OK</td> <td>0</td> <td>--/-- --:--</td> <td>--/-- --:--</td> </tr> <tr> <td>HDLS PAYLOAD SYNC</td> <td>MN</td> <td>OK</td> <td>0</td> <td>--/-- --:--</td> <td>--/-- --:--</td> </tr> <tr> <td>COLU-ATLU MISMATCH</td> <td>MN</td> <td>OK</td> <td>0</td> <td>--/-- --:--</td> <td>--/-- --:--</td> </tr> <tr> <td>ATCU CONFIG MISMATCH</td> <td>MJ</td> <td>OK</td> <td>1</td> <td>01/01 00:07</td> <td>01/01 00:07</td> </tr> <tr> <td>NO ATLU SW</td> <td>MN</td> <td>OK</td> <td>0</td> <td>--/-- --:--</td> <td>--/-- --:--</td> </tr> </tbody> </table> <p>Below the table are several menu options: PAGE BACKWARD, PAGE FORWARD, GO TO ALARMS SUMMARY, DISPLAY ATLU ALARMS, and CLEAR ALL SYSTEM ALARM HISTORY (highlighted). At the bottom, it says 'SYSTEM ALARM HISTORY LAST CLEARED: --/--/---- --:--:--'. The footer shows the date '07/18/2002', 'SYSTEM ID: PG-Flex', and time '13:38:50'.</p> <p> The status <i>OK</i> displays in the <i>Current</i> column when the alarm is not present. The status <i>Active</i> displays when an alarm is present (see Table 17 on page 84 for COLU Alarms - Universal). A description of the Alarm types reported is provided in Table 15 on page 82.</p>	COLU ALARMS	TYPE	CURRENT	COUNT	FIRST	LAST	DSL POWER FAULT	MJ	OK	0	--/-- --:--	--/-- --:--	DSL POWER FEED OPEN	MJ	OK	0	--/-- --:--	--/-- --:--	DSL POWER FEED SHORT	MJ	OK	0	--/-- --:--	--/-- --:--	DSL POWER GROUND FAULT	MN	OK	0	--/-- --:--	--/-- --:--	HDLS PAYLOAD SYNC	MN	OK	0	--/-- --:--	--/-- --:--	COLU-ATLU MISMATCH	MN	OK	0	--/-- --:--	--/-- --:--	ATCU CONFIG MISMATCH	MJ	OK	1	01/01 00:07	01/01 00:07	NO ATLU SW	MN	OK	0	--/-- --:--	--/-- --:--
COLU ALARMS	TYPE	CURRENT	COUNT	FIRST	LAST																																																		
DSL POWER FAULT	MJ	OK	0	--/-- --:--	--/-- --:--																																																		
DSL POWER FEED OPEN	MJ	OK	0	--/-- --:--	--/-- --:--																																																		
DSL POWER FEED SHORT	MJ	OK	0	--/-- --:--	--/-- --:--																																																		
DSL POWER GROUND FAULT	MN	OK	0	--/-- --:--	--/-- --:--																																																		
HDLS PAYLOAD SYNC	MN	OK	0	--/-- --:--	--/-- --:--																																																		
COLU-ATLU MISMATCH	MN	OK	0	--/-- --:--	--/-- --:--																																																		
ATCU CONFIG MISMATCH	MJ	OK	1	01/01 00:07	01/01 00:07																																																		
NO ATLU SW	MN	OK	0	--/-- --:--	--/-- --:--																																																		

ALARMS — COLU System History (Universal) (Continued)

Step	Action
3	<p>The following actions can be taken:</p> <ol style="list-style-type: none"> To scroll through the COLU system alarm history, select the PAGE FORWARD or PAGE BACKWARD button, then press ENTER. To view a summary of all active alarms, select the GO TO ALARMS SUMMARY button, then press ENTER. To view the RTLU alarm information, select the DISPLAY RTLU ALARMS button, then press ENTER. To clear the COLU alarm history, select the CLEAR ALL SYSTEM ALARM HISTORY button, then press ENTER. From the SYSTEM ALARM HISTORY WILL BE CLEARED. CONTINUE (Y/N)? prompt, the following actions can be taken: <ul style="list-style-type: none"> To clear the COLU alarm history, press Y. The following events occur: <ol style="list-style-type: none"> COLU alarm history counts are set to zero time and date that the registers were last cleared are updated <div data-bbox="479 772 1242 1228" style="border: 1px solid black; padding: 5px; margin: 10px 0;"> <pre> PG-FlexPlus RT Line Unit MAIN PERFORMANCE ALARMS CONFIG TEST INFO COLU System History COLU ALARMS TYPE CURRENT COUNT FIRST LAST DSL POWER FAULT MJ OK 0 --/-- --:-- --:-- DSL POWER FEED OPEN MJ OK 0 --/-- --:-- --:-- DSL POWER FEED SHORT MJ OK 0 --/-- --:-- --:-- DSL POWER GROUND FAULT MN OK 0 --/-- --:-- --:-- HD SL PAYLOAD SYNC MN OK 0 --/-- --:-- --:-- COLU-RTLU MISMATCH MN OK 0 --/-- --:-- --:-- RTCU CONFIG MISMATCH MJ OK 1 01/01 00:07 01/01 00:07 NO RTLU SW MN OK 0 --/-- --:-- --:-- PAGE BACKWARD PAGE FORWARD GO TO ALARMS SUMMARY DISPLAY RTLU ALARMS CLEAR ALL SYSTEM ALARM HISTORY SYSTEM ALARM HISTORY WILL BE CLEARED. CONTINUE (Y/N)? SYSTEM ALARM HISTORY LAST CLEARED: --/--/---- --:--:-- 07/18/2002 SYSTEM ID: PG-Flex 13:39:34 </pre> </div> <div data-bbox="479 1255 1242 1711" style="border: 1px solid black; padding: 5px; margin: 10px 0;"> <pre> PG-FlexPlus RT Line Unit MAIN PERFORMANCE ALARMS CONFIG TEST INFO COLU System History COLU ALARMS TYPE CURRENT COUNT FIRST LAST DSL POWER FAULT MJ OK 0 --/-- --:-- --:-- DSL POWER FEED OPEN MJ OK 0 --/-- --:-- --:-- DSL POWER FEED SHORT MJ OK 0 --/-- --:-- --:-- DSL POWER GROUND FAULT MN OK 0 --/-- --:-- --:-- HD SL PAYLOAD SYNC MN OK 0 --/-- --:-- --:-- COLU-RTLU MISMATCH MN OK 0 --/-- --:-- --:-- RTCU CONFIG MISMATCH MJ OK 0 --/-- --:-- --:-- NO RTLU SW MN OK 0 --/-- --:-- --:-- PAGE BACKWARD PAGE FORWARD GO TO ALARMS SUMMARY DISPLAY RTLU ALARMS CLEAR ALL SYSTEM ALARM HISTORY SYSTEM ALARM HISTORY LAST CLEARED: 07/18/2002 13:39:54 07/18/2002 SYSTEM ID: PG-Flex 13:40:00 </pre> </div>
	<p> Clearing the alarm history does not clear any alarm that is currently active in the system.</p> <p> If there is an active alarm, the count is set to 1 and the value in the LAST date and time field is set to the FIRST date and time field.</p> <ul style="list-style-type: none"> To retain the existing COLU alarm history, press N.

ALARMS — COLU System History (Universal) (Continued)

Step	Action
4	Press ESC . The Main Menu screen reappears.

ALARMS — RTLU System History

This screen displays the RTLU alarm history. Information includes a count of the number of times each alarm occurred, the time and date of the first and last occurrence, the provisioned alarm type, and the current status.

ALARMS — RTLU System History

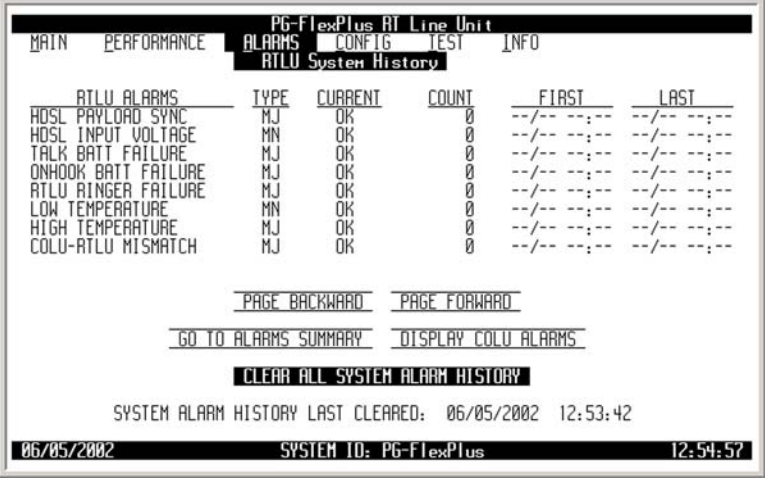
Step	Action
1	<p>At the Main Menu screen, select ALARMS. Press ↓ to choose RTLU System History. The following screen appears.</p> 
2	<p>Press ENTER. The following screen appears.</p>  <p>The status <i>OK</i> displays in the <i>Current</i> column when the alarm is not present. The status <i>Active</i> displays when an alarm is present (see Table 18 on page 87 for RTLU Alarms). A description of the Alarm types reported is provided in Table 15 on page 82.</p>

ALARMS — RTLU System History (Continued)

Step	Action
3	<p>The following actions can be taken:</p> <ol style="list-style-type: none"> To scroll through the RTLU system alarm history, select the PAGE FORWARD or PAGE BACKWARD button, then press ENTER. To view a summary of all active alarms, select the GO TO ALARMS SUMMARY button, then press ENTER. To view the COLU alarm information, select the DISPLAY COLU ALARMS button, then press ENTER. To clear the RTLU alarm history, select the CLEAR ALL SYSTEM ALARM HISTORY button, then press ENTER. From the SYSTEM ALARM HISTORY WILL BE CLEARED. CONTINUE (Y/N)? prompt, the following actions can be taken: <ul style="list-style-type: none"> To clear the RTLU alarm history, press Y. The following events occur: <ol style="list-style-type: none"> RTLU alarm history counts are set to zero time and date that the registers were last cleared are updated <div style="text-align: center;">  <p>The screenshot shows the RTLU System History screen with a table of alarms. The 'COUNT' column shows zeros for all listed alarms. Below the table, the 'CLEAR ALL SYSTEM ALARM HISTORY' option is highlighted, and a prompt asks 'SYSTEM ALARM HISTORY WILL BE CLEARED. CONTINUE (Y/N)?'. The 'LAST CLEARED' time is 06/05/2002 12:53:42.</p> </div> <div style="text-align: center;">  <p>The second screenshot shows the same screen after clearing the history. The 'LAST CLEARED' time is now 06/05/2002 12:56:04.</p> </div> <p>  Clearing the alarm history does not clear any alarm that is currently active in the system. </p> <p>  If there is an active alarm, the count is set to 1 and the value in the LAST date and time field is set to the FIRST date and time field. </p> <ul style="list-style-type: none"> To retain the existing RTLU alarm history, press N.

ALARMS — RTLU System History (Continued)

Step	Action
4	Press ESC . The Main Menu screen reappears.



ALARMS — HDSL History

This screen displays the HDSL alarm history for each span in the system. Information includes a count of the number of times each alarm occurred, the time and date of the first and last occurrence, the provisioned alarm type, and the current status.

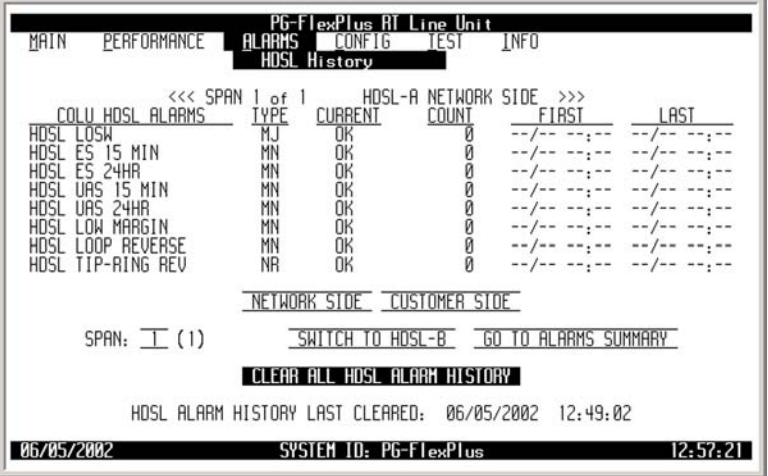
ALARMS — HDSL History

Step	Action
1	<p>At the Main Menu screen, select ALARMS. Press ↓ to choose HDSL History. The following screen appears.</p> 
2	<p>Press ENTER. The following screen appears.</p>  <p>The status <i>OK</i> displays in the <i>Current</i> column when the alarm is not present. The status <i>Active</i> displays when an alarm is present (see Table 20 on page 93 for HDSL Alarms). A description of the Alarm types reported is provided in Table 15 on page 82.</p>

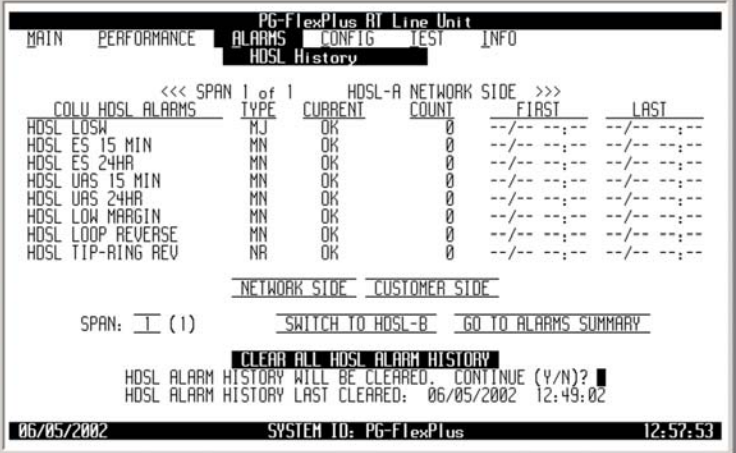
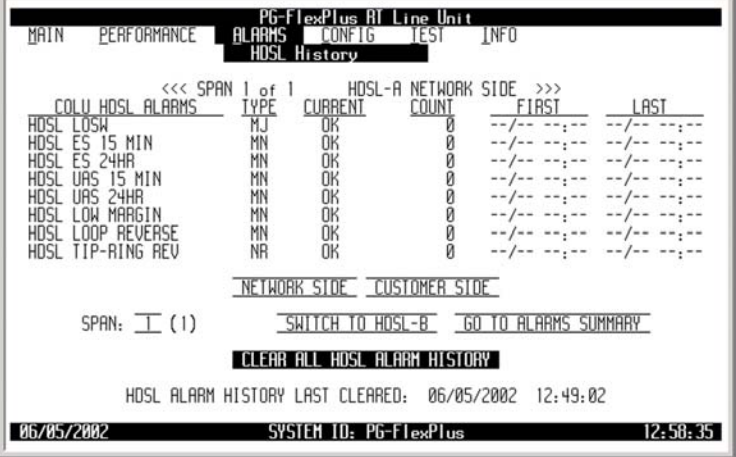
ALARMS — HDSL History (Continued)

Step	Action																																																															
3	<p>The following actions can be taken:</p> <ol style="list-style-type: none"> To view additional spans, select the SPAN field and press SPACEBAR to toggle to the other spans, then press ENTER. To view the network side or the customer side of the HDSL alarm history, select the NETWORK SIDE or CUSTOMER SIDE button, then press ENTER. To view the HDSL alarm history for HDSL-B or HDSL-A, select the SWITCH TO HDSL-B or SWITCH TO HDSL-A button, then press ENTER. To view a summary of all active alarms, select the GO TO ALARMS SUMMARY button, then press ENTER. To clear the HDSL alarm history, select the CLEAR ALL HDSL ALARM HISTORY button, then press ENTER. From the HDSL ALARM HISTORY WILL BE CLEARED. CONTINUE (Y/N)? prompt, the following actions can be taken: <ul style="list-style-type: none"> To clear the HDSL alarm history, press Y. The following events occur: <ol style="list-style-type: none"> all HDSL alarm history counts are set to zero time and date that the registers were last cleared are updated 																																																															
	 <p>The screenshot shows the HDSL History screen with the following data:</p> <table border="1"> <thead> <tr> <th>COLU</th> <th>HDSL ALARMS</th> <th>TYPE</th> <th>CURRENT</th> <th>COUNT</th> <th>FIRST</th> <th>LAST</th> </tr> </thead> <tbody> <tr><td>HDSL</td><td>LOSH</td><td>MJ</td><td>OK</td><td>0</td><td>--/--</td><td>--/--</td></tr> <tr><td>HDSL</td><td>ES 15 MIN</td><td>MN</td><td>OK</td><td>0</td><td>--/--</td><td>--/--</td></tr> <tr><td>HDSL</td><td>ES 24HR</td><td>MN</td><td>OK</td><td>0</td><td>--/--</td><td>--/--</td></tr> <tr><td>HDSL</td><td>URS 15 MIN</td><td>MN</td><td>OK</td><td>0</td><td>--/--</td><td>--/--</td></tr> <tr><td>HDSL</td><td>URS 24HR</td><td>MN</td><td>OK</td><td>0</td><td>--/--</td><td>--/--</td></tr> <tr><td>HDSL</td><td>LOW MARGIN</td><td>MN</td><td>OK</td><td>0</td><td>--/--</td><td>--/--</td></tr> <tr><td>HDSL</td><td>LOOP REVERSE</td><td>MN</td><td>OK</td><td>0</td><td>--/--</td><td>--/--</td></tr> <tr><td>HDSL</td><td>TIP-RING REV</td><td>NR</td><td>OK</td><td>0</td><td>--/--</td><td>--/--</td></tr> </tbody> </table> <p>Options displayed: NETWORK SIDE, CUSTOMER SIDE, SPAN: 1 (1), SWITCH TO HDSL-B, GO TO ALARMS SUMMARY, CLEAR ALL HDSL ALARM HISTORY. Prompt: HDSL ALARM HISTORY WILL BE CLEARED. CONTINUE (Y/N)?</p>	COLU	HDSL ALARMS	TYPE	CURRENT	COUNT	FIRST	LAST	HDSL	LOSH	MJ	OK	0	--/--	--/--	HDSL	ES 15 MIN	MN	OK	0	--/--	--/--	HDSL	ES 24HR	MN	OK	0	--/--	--/--	HDSL	URS 15 MIN	MN	OK	0	--/--	--/--	HDSL	URS 24HR	MN	OK	0	--/--	--/--	HDSL	LOW MARGIN	MN	OK	0	--/--	--/--	HDSL	LOOP REVERSE	MN	OK	0	--/--	--/--	HDSL	TIP-RING REV	NR	OK	0	--/--	--/--
COLU	HDSL ALARMS	TYPE	CURRENT	COUNT	FIRST	LAST																																																										
HDSL	LOSH	MJ	OK	0	--/--	--/--																																																										
HDSL	ES 15 MIN	MN	OK	0	--/--	--/--																																																										
HDSL	ES 24HR	MN	OK	0	--/--	--/--																																																										
HDSL	URS 15 MIN	MN	OK	0	--/--	--/--																																																										
HDSL	URS 24HR	MN	OK	0	--/--	--/--																																																										
HDSL	LOW MARGIN	MN	OK	0	--/--	--/--																																																										
HDSL	LOOP REVERSE	MN	OK	0	--/--	--/--																																																										
HDSL	TIP-RING REV	NR	OK	0	--/--	--/--																																																										
	 <p>The screenshot shows the HDSL History screen after clearing the alarm history. The data is identical to the previous screenshot, but the counts are now 0 and the last cleared date is 06/05/2002 12:49:02.</p>																																																															
	<p> Clearing the alarm history does not clear any alarm that is currently active in the system. If there is an active alarm, the count is set to 1 and the value in the LAST date and time field is set to the FIRST date and time field.</p> <ul style="list-style-type: none"> To retain the existing HDSL alarm history, press N. 																																																															

ALARMS — HDSL History (Continued)

Step	Action
4	Press ESC . The Main Menu screen reappears.

ALARMS — ISDN History

This screen displays the ISDN alarm history. Information includes the provisionable alarm type, the current status of the alarm, the number of times the alarm was reported, the date and time of the first and last occurrence, and the current status.

ALARMS — ISDN History

Step	Action
1	<p>At the Main Menu screen, select ALARMS. Press ↓ to choose ISDN History. The following screen appears.</p>  <p>The screenshot shows a terminal-style menu for 'PG-FlexPlus AT Line Unit'. The menu items are: MAIN, PERFORMANCE, ALARMS, CONFIG, TEST, and INFO. Under the 'ALARMS' menu, the following options are listed: Alarms Summary, COLU System History, ATLU System History, HDSL History, ISDN History (which is highlighted with a black bar), CU History, COLU Faults, and ATLU Faults. At the bottom of the screen, the date '06/05/2002', 'SYSTEM ID: PG-FlexPlus', and the time '12:59:09' are displayed.</p>

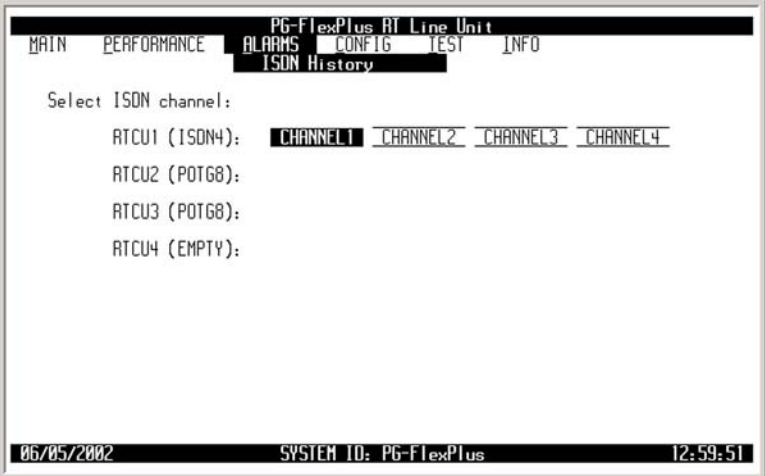
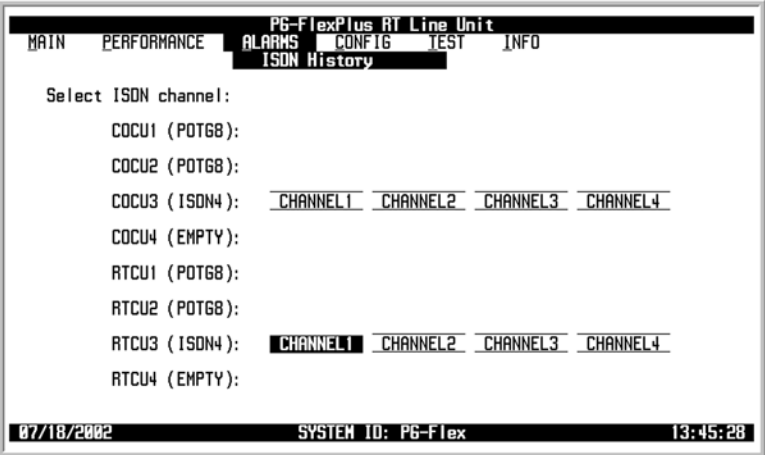

ALARMS — ISDN History (Continued)

Step	Action
2	<p>Integrated:</p> <p>Press ENTER. The following screen appears.</p>  <p>To view the ISDN History, select the ISDN channel, then press ENTER.</p> <p>Universal:</p> <p>Press ENTER. The following screen appears.</p>  <p>To view the ISDN History, select the ISDN channel, then press ENTER.</p>

ALARMS — ISDN History (Continued)

Step	Action
3	<p>To view the ISDN history data, select the ISDN channel, then press ENTER. The following screen appears.</p> <div data-bbox="479 388 1242 871" style="border: 1px solid black; padding: 5px;"> <pre> PG-FlexPlus AT Line Unit MAIN PERFORMANCE ALARMS CONFIG TEST INFO ISDN History <<< ATCU: 1 CH: 1 >>> ATCU ALARMS TYPE CURRENT COUNT FIRST LAST DSL LOSS OF FRAME MN ACTIVE 1 06/05 08:58 06/05 08:58 DSL LOSS OF SIGNAL MN ACTIVE 1 06/05 08:58 06/05 08:58 D+ LOSS OF FRAME MN ACTIVE 1 06/05 08:58 06/05 08:58 D+ LOSS OF SIGNAL MN ACTIVE 1 06/05 08:58 06/05 08:58 ES HOURLY (CUST) MN OK 0 --/-- --:-- --/-- --:-- ES DAILY (CUST) MN OK 0 --/-- --:-- --/-- --:-- SES HOURLY (CUST) MN OK 0 --/-- --:-- --/-- --:-- SES DAILY (CUST) MN OK 0 --/-- --:-- --/-- --:-- ES HOURLY (NTWK) MN OK 0 --/-- --:-- --/-- --:-- ES DAILY (NTWK) MN OK 0 --/-- --:-- --/-- --:-- SES HOURLY (NTWK) MN OK 0 --/-- --:-- --/-- --:-- SES DAILY (NTWK) MN OK 0 --/-- --:-- --/-- --:-- GO TO ISDN HISTORY GO TO ALARMS SUMMARY CLEAR ALL ISDN ALARM HISTORY ISDN ALARM HISTORY LAST CLEARED: 06/05/2002 12:49:02 06/05/2002 SYSTEM ID: PG-FlexPlus 13:00:25 </pre> </div> <p> The status <i>OK</i> displays in the <i>Current</i> column when the alarm is not present. The status <i>Active</i> displays when an alarm is present. A description of the Alarm types reported is provided in Table 15 on page 82.</p>

ALARMS — ISDN History (Continued)

Step	Action
4	<p>The following actions can be taken:</p> <ol style="list-style-type: none"> To view a summary of all active alarms, select the GO TO ALARMS SUMMARY button, then press ENTER. To go to other ISDN History, select GO TO ISDN HISTORY button, then press ENTER. To clear the ISDN alarm history, select the CLEAR ALL ISDN ALARM HISTORY button, then press ENTER. From the ISDN ALARM HISTORY WILL BE CLEARED. CONTINUE (Y/N)? prompt, the following actions can be taken: <ul style="list-style-type: none"> To clear the ISDN alarm history, press Y. The following events occur: <ol style="list-style-type: none"> all ISDN alarm history counts are set to zero time and date that the registers were last cleared are updated <div data-bbox="479 682 1242 1144" style="border: 1px solid black; padding: 5px; margin: 10px 0;"> <pre> PG-Fl exPlus AT Line Unit MAIN PERFORMANCE ALARMS CONFIG TEST INFO ISDN History <<< ATCU: 1 CH: 1 >>> ATCU ALARMS DSL LOSS OF FRAME MN ACTIVE 1 06/05 08:58 06/05 08:58 DSL LOSS OF SIGNAL MN ACTIVE 1 06/05 08:58 06/05 08:58 D+ LOSS OF FRAME MN ACTIVE 1 06/05 08:58 06/05 08:58 D+ LOSS OF SIGNAL MN ACTIVE 1 06/05 08:58 06/05 08:58 ES HOURLY (CUST) MN OK 0 --/-- --:-- --/-- --:-- ES DAILY (CUST) MN OK 0 --/-- --:-- --/-- --:-- SES HOURLY (CUST) MN OK 0 --/-- --:-- --/-- --:-- SES DAILY (CUST) MN OK 0 --/-- --:-- --/-- --:-- ES HOURLY (NTWK) MN OK 0 --/-- --:-- --/-- --:-- ES DAILY (NTWK) MN OK 0 --/-- --:-- --/-- --:-- SES HOURLY (NTWK) MN OK 0 --/-- --:-- --/-- --:-- SES DAILY (NTWK) MN OK 0 --/-- --:-- --/-- --:-- GO TO ISDN HISTORY GO TO ALARMS SUMMARY CLEAR ALL ISDN ALARM HISTORY ISDN ALARM HISTORY WILL BE CLEARED. CONTINUE (Y/N)? ISDN ALARM HISTORY LAST CLEARED: 06/05/2002 12:49:02 06/05/2002 SYSTEM ID: PG-Fl exPlus 13:00:57 </pre> </div> <div data-bbox="479 1176 1242 1638" style="border: 1px solid black; padding: 5px; margin: 10px 0;"> <pre> PG-Fl exPlus AT Line Unit MAIN PERFORMANCE ALARMS CONFIG TEST INFO ISDN History <<< ATCU: 1 CH: 1 >>> ATCU ALARMS DSL LOSS OF FRAME MN ACTIVE 1 06/05 08:58 06/05 08:58 DSL LOSS OF SIGNAL MN ACTIVE 1 06/05 08:58 06/05 08:58 D+ LOSS OF FRAME MN ACTIVE 1 06/05 08:58 06/05 08:58 D+ LOSS OF SIGNAL MN ACTIVE 1 06/05 08:58 06/05 08:58 ES HOURLY (CUST) MN OK 0 --/-- --:-- --/-- --:-- ES DAILY (CUST) MN OK 0 --/-- --:-- --/-- --:-- SES HOURLY (CUST) MN OK 0 --/-- --:-- --/-- --:-- SES DAILY (CUST) MN OK 0 --/-- --:-- --/-- --:-- ES HOURLY (NTWK) MN OK 0 --/-- --:-- --/-- --:-- ES DAILY (NTWK) MN OK 0 --/-- --:-- --/-- --:-- SES HOURLY (NTWK) MN OK 0 --/-- --:-- --/-- --:-- SES DAILY (NTWK) MN OK 0 --/-- --:-- --/-- --:-- GO TO ISDN HISTORY GO TO ALARMS SUMMARY CLEAR ALL ISDN ALARM HISTORY ISDN ALARM HISTORY LAST CLEARED: 06/05/2002 12:49:02 06/05/2002 SYSTEM ID: PG-Fl exPlus 13:01:35 </pre> </div>
	<p> Clearing the alarm history does not clear any alarm that is currently active in the system.</p> <p> If there is an active alarm, the count is set to 1 and the value in the LAST date and time field is set to the FIRST date and time field.</p> <ul style="list-style-type: none"> To retain the existing ISDN alarm history, press N.



ALARMS — ISDN History (Continued)

Step	Action
5	Press ESC . The Main Menu screen reappears.

ALARMS — CU History

This screen displays the Channel Unit alarm history. Information includes the provisionable alarm type, the current status of the alarm, the number of times the alarm was reported, the date and time of the first and last occurrence and the current status.

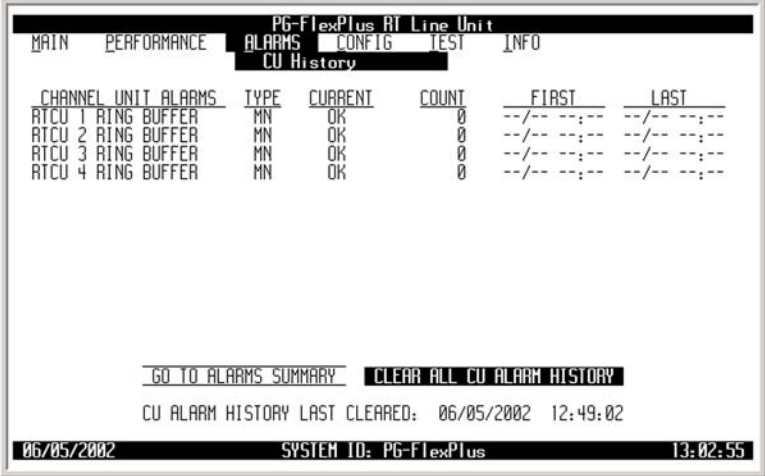
ALARMS — CU History

Step	Action
1	<p>At the Main Menu screen, select ALARMS. Press ↓ to choose CU History. The following screen appears.</p>  <p>The screenshot shows a terminal window with the title 'PG-FlexPlus AT Line Unit'. The menu options are: MAIN, PERFORMANCE, ALARMS (selected), CONFIG, TEST, INFO. Under ALARMS, the options are: Alarms Summary, COLU System History, ATLU System History, HDSL History, ISDN History, CU History (highlighted), COLU Faults, and ATLU Faults. The status bar at the bottom shows '06/05/2002', 'SYSTEM ID: PG-FlexPlus', and '13:02:07'.</p>
2	<p>Press ENTER. The following screen appears.</p>  <p>The screenshot shows the 'CU History' screen with a table of alarm data. The title is 'PG-FlexPlus AT Line Unit'. The menu options are: MAIN, PERFORMANCE, ALARMS (selected), CONFIG, TEST, INFO. The table has the following columns: CHANNEL UNIT ALARMS, TYPE, CURRENT, COUNT, FIRST, and LAST. The data rows are: ATCU 1 RING BUFFER (MN, OK, 0, --/--:--:--), ATCU 2 RING BUFFER (MN, OK, 0, --/--:--:--), ATCU 3 RING BUFFER (MN, OK, 0, --/--:--:--), and ATCU 4 RING BUFFER (MN, OK, 0, --/--:--:--). At the bottom, there are two buttons: 'GO TO ALARMS SUMMARY' and 'CLEAR ALL CU ALARM HISTORY'. Below the buttons, it says 'CU ALARM HISTORY LAST CLEARED: 06/05/2002 12:49:02'. The status bar at the bottom shows '06/05/2002', 'SYSTEM ID: PG-FlexPlus', and '13:02:55'.</p> <p> The status <i>OK</i> displays in the <i>Current</i> column when the alarm is not present. The status <i>Active</i> displays when an alarm is present (see Table 24 on page 105 for Channel Unit Alarms). A description of the Alarm types reported is provided in Table 15 on page 82.</p>

ALARMS — CU History (Continued)

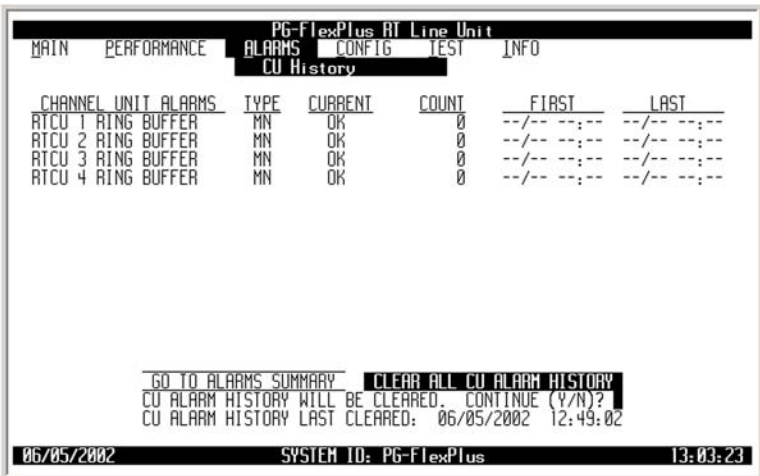
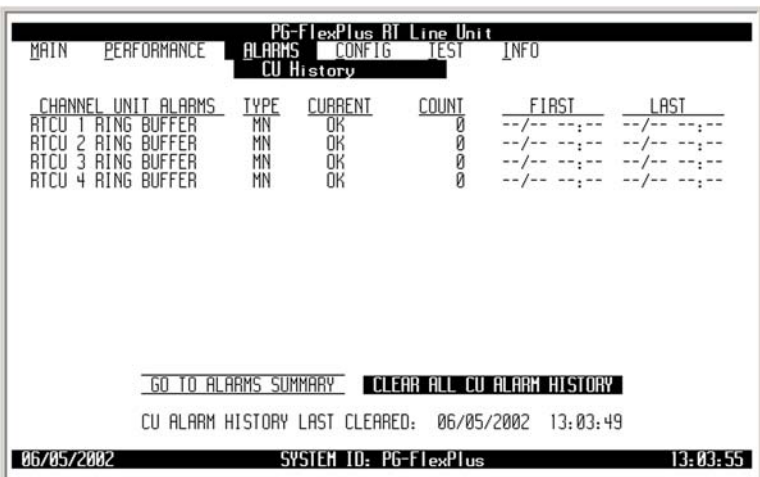

Step	Action																																								
3	<p>The following actions can be taken:</p> <ol style="list-style-type: none"> To view a summary of all active alarms, select the GO TO ALARMS SUMMARY button, then press ENTER. To clear the CU alarm history, select the CLEAR ALL CU ALARM HISTORY button, then press ENTER. From the CU ALARM HISTORY WILL BE CLEARED. CONTINUE (Y/N)? prompt, the following actions can be taken: <ul style="list-style-type: none"> To clear the CU alarm history, press Y. The following events occur: <ol style="list-style-type: none"> all CU alarm history counts are set to zero time and date that the registers were last cleared are updated <div style="text-align: center;">  <p>The screenshot shows the CU History screen with the following data:</p> <table border="1"> <thead> <tr> <th>CHANNEL</th> <th>UNIT</th> <th>ALARMS</th> <th>TYPE</th> <th>CURRENT</th> <th>COUNT</th> <th>FIRST</th> <th>LAST</th> </tr> </thead> <tbody> <tr> <td>RTC1</td> <td>RING</td> <td>BUFFER</td> <td>MN</td> <td>OK</td> <td>0</td> <td>--/-- --:--</td> <td>--/-- --:--</td> </tr> <tr> <td>RTC2</td> <td>RING</td> <td>BUFFER</td> <td>MN</td> <td>OK</td> <td>0</td> <td>--/-- --:--</td> <td>--/-- --:--</td> </tr> <tr> <td>RTC3</td> <td>RING</td> <td>BUFFER</td> <td>MN</td> <td>OK</td> <td>0</td> <td>--/-- --:--</td> <td>--/-- --:--</td> </tr> <tr> <td>RTC4</td> <td>RING</td> <td>BUFFER</td> <td>MN</td> <td>OK</td> <td>0</td> <td>--/-- --:--</td> <td>--/-- --:--</td> </tr> </tbody> </table> <p>At the bottom, the prompt reads: "CU ALARM HISTORY WILL BE CLEARED. CONTINUE (Y/N)?". The "LAST CLEARED" timestamp is 06/05/2002 12:49:02.</p> </div> <div style="text-align: center;">  <p>The screenshot shows the CU History screen after clearing. The data is identical to the previous screenshot, but the "LAST CLEARED" timestamp is now 06/05/2002 13:03:49.</p> </div> <p>Clearing the alarm history does not clear any alarm that is currently active in the system.</p> <p>If there is an active alarm, the count is set to 1 and the value in the LAST date and time field is set to the FIRST date and time field.</p> <ul style="list-style-type: none"> To retain the existing CU alarm history, press N. 	CHANNEL	UNIT	ALARMS	TYPE	CURRENT	COUNT	FIRST	LAST	RTC1	RING	BUFFER	MN	OK	0	--/-- --:--	--/-- --:--	RTC2	RING	BUFFER	MN	OK	0	--/-- --:--	--/-- --:--	RTC3	RING	BUFFER	MN	OK	0	--/-- --:--	--/-- --:--	RTC4	RING	BUFFER	MN	OK	0	--/-- --:--	--/-- --:--
CHANNEL	UNIT	ALARMS	TYPE	CURRENT	COUNT	FIRST	LAST																																		
RTC1	RING	BUFFER	MN	OK	0	--/-- --:--	--/-- --:--																																		
RTC2	RING	BUFFER	MN	OK	0	--/-- --:--	--/-- --:--																																		
RTC3	RING	BUFFER	MN	OK	0	--/-- --:--	--/-- --:--																																		
RTC4	RING	BUFFER	MN	OK	0	--/-- --:--	--/-- --:--																																		

ALARMS — CU History (Continued)

Step	Action
4	Press ESC . The Main Menu screen reappears.



ALARMS — COLU Faults

This screen displays any faults detected in the CO Line Unit.

Step	Action
1	<p>At the Main Menu screen, select ALARMS. Press ↓ to choose COLU Faults. The following screen appears.</p>  <p>The screenshot shows a terminal window with a menu structure. At the top, it says 'PG-FlexPlus RT Line Unit'. Below that are several menu options: MAIN, PERFORMANCE, ALARMS, CONFIG, TEST, and INFO. Under the ALARMS option, there is a list of sub-options: Alarms Summary, COLU System History, ATLU System History, HDGL History, ISDN History, CU History, COLU Faults (which is highlighted with a black bar), and ATLU Faults. At the bottom of the terminal window, there is a status bar showing '06/05/2002', 'SYSTEM ID: PG-FlexPlus', and '13:04:31'.</p>
2	<p>Press ENTER. The following screen appears.</p>  <p>The screenshot shows the same terminal window as in step 1, but now the 'COLU Faults' option is selected. The main area of the screen displays the text 'NO FAULTS ON COT LINE UNIT'. The status bar at the bottom remains the same, showing '06/05/2002', 'SYSTEM ID: PG-FlexPlus', and '13:05:23'.</p> <p> If there are no faults detected, then the COLU Faults screen displays the message NO FAULTS ON COT LINE UNIT. If there is a fault detected, a descriptive message appears.</p>
3	<p>Press ESC. The Main Menu screen reappears.</p>

ALARMS — RTLU Faults

This screen displays any faults detected on the RT Line Unit.

Step	Action
1	<p>At the Main Menu screen, select ALARMS. Press ↓ to choose RTLU Faults. The following screen appears.</p> 
2	<p>Press ENTER. The following screen appears.</p>  <p> If there are no faults detected, then the RT Faults screen displays the message NO FAULTS ON RT LINE UNIT. If there is a fault detected, a descriptive message appears.</p>
3	<p>Press ESC. The Main Menu screen reappears.</p>

CONFIGURATION MENU OPTIONS

The Configuration Menu provides access to system provisioning and setting all options to factory defaults, etc. Refer to [Table 12](#) for sub-menu options and descriptions, parameters and valid values.



ISDN menu selections are only present if ISDN is installed the system.

On the last CONFIG Menu Option, Timeslot Configuration menu option is present in an Integrated setup and Channel Configuration menu option is present in an Universal setup. The Integrated setup is shown below.

IMPORTANT



To make configuration changes from the RTLU, you must enable this option in the COLU. Refer to COLU documentation for information on enabling this option.



Table 12. Configuration Menu Options

Sub-Menu Options	Sub-Menu Descriptions	Parameters	Valid Values
System Options (See Table 13 on page 78 for System Options - Integrated) (See Table 14 on page 79 for System Options - Universal)	Set system options	System Options will be changed. Continue (Y/N)?	Y or N

Sub-Menu Options	Sub-Menu Descriptions	Parameters	Valid Values
COLU System Alarm Types (See Table 16 on page 83 for COLU Alarms-Integrated) (See Table 17 on page 84 for COLU Alarms-Universal)	Provision COLU alarm types	System Alarm Types will be Changed. Continue (Y/N)?	Y or N
RTLU System Alarm Types (See Table 18 on page 87 for RTLU System Alarm Types)	Provision RTLU alarm types	System Alarm Types will be Changed. Continue (Y/N)?	Y or N
HDSL Alarm Thresholds (See Table 19 on page 90 for HDSL Alarm Thresholds)	Provision HDSL alarm thresholds	HDSL Alarm Thresholds will be Changed. Continue (Y/N)?	Y or N
HDSL Alarm Types (See Table 20 on page 93 for HDSL Alarm Types)	Provision HDSL alarm types	HDSL Alarm Types will be Changed. Continue (Y/N)?	Y or N
ISDN Options (See Table 21 on page 96 for ISDN Options)	Provision ISDN options	ISDN Options will be changed. Continue (Y/N)?	Y or N
ISDN Alarm Thresholds (See Table 22 on page 99 for ISDN Alarm Thresholds)	Provision ISDN alarm thresholds	ISDN Thresholds will be changed. Continue (Y/N)?	Y or N

Sub-Menu Options	Sub-Menu Descriptions	Parameters	Valid Values
ISDN Alarm Types (See Table 23 on page 102 for ISDN Alarm Thresholds)	Provision ISDN alarm types	ISDN Alarm Types will be changed. Continue (Y/N)?	Y or N
Channel Unit Alarm Types (See Table 24 on page 105 for Channel Unit Alarm Types)	Provision channel unit alarm types	Channel Unit Alarm Types will be Changed. Continue (Y/N)?	Y or N
POTS Options (See Table 25 on page 108 for POTS Options)	Provision the ringing frequency for POTS lines	POTS Options will be Changed. Continue (Y/N)?	Y or N
LS/GS Options	View the Loop Start/Ground Start (LS/GS) circuit configuration		
Set Factory Defaults	Reset the provisionable items to the original factory settings	<ul style="list-style-type: none"> • Configuration data will be set to factory defaults (This May Be Service Affecting!) Continue (Y/N)? • Configuration data has been set to factory defaults. Press ESC to continue: 	<ul style="list-style-type: none"> • Y or N • ESC

Sub-Menu Options	Sub-Menu Descriptions	Parameters	Valid Values
Timeslot Configuration (Integrated setup) (See Table 26 on page 118 for Timeslot Configuration Options)	Allows mapping of a timeslot to a channel and channel unit	Timeslot Configuration will be Changed. Continue (Y/N)?	Y or N
Channel Configuration (Universal setup)	Allows each individual channel to be set as enabled or disabled	<ul style="list-style-type: none"> • Channel Configuration will be Changed. Continue (Y/N)? • All Channel will be Enabled. Continue (Y/N)? • All Channel will be Disabled. Continue (Y/N)? 	<ul style="list-style-type: none"> • Y or N • Y or N • Y or N

CONFIG — System Options

The System Options screen allows provisioning of system options such as Subscriber Test Response Mode and System ID. Refer to [Table 13 on page 78](#) for System Options (Integrated) and [Table 14 on page 79](#) for System Options (Universal).

CONFIG — System Options

Step	Action
1	<p>At the Main Menu screen, select CONFIG. Press ↓ to choose System Options. The following screen appears.</p> 

CONFIG — System Options (Continued)

Step	Action
<p>2</p>	<p>Integrated: Press ENTER. The following screen appears.</p> <div data-bbox="479 443 1239 919" style="border: 1px solid black; padding: 5px;"> <pre> PG-FlexPlus RT Line Unit MAIN PERFORMANCE ALARMS CONFIG TEST INFO System Options System Options Current Possible values Subscriber Test Response Mode : TA-909 (NONE, TA-909) PG-FlexPlus System ID (24 chars max) : PG-FlexPlus RT Auto Logout : DISABLED (DISABLED, 5, 30, 60) ACCEPT SYSTEM OPTION CHANGES 06/05/2002 SYSTEM ID: PG-FlexPlus 13:08:53 </pre> </div> <p>Universal: Press ENTER. The following screen appears.</p> <div data-bbox="479 1083 1239 1535" style="border: 1px solid black; padding: 5px;"> <pre> PG-FlexPlus RT Line Unit MAIN PERFORMANCE ALARMS CONFIG TEST INFO System Options System Options Current Possible values Subscriber Test Response Mode : BYPASS (NONE, BYPASS, TA-909) PG-FlexPlus System ID (24 chars max) : PG-Flex RT Auto Logout : DISABLED (DISABLED, 5, 30, 60) COLU Auto Logout : DISABLED (DISABLED, 5, 30, 60) Termination Timeout (Metallic Access) : OFF (OFF, 30, 60, 120) ACCEPT SYSTEM OPTION CHANGES 07/18/2002 SYSTEM ID: PG-Flex 13:46:42 </pre> </div>

CONFIG — System Options (Continued)

Step	Action
3	<p>The following actions can be taken:</p> <ol style="list-style-type: none"> To change the System Option values, press SPACEBAR to toggle to the desired value, or press ↓ or ↑ to move to the next option. To save the shelf options, select the ACCEPT SYSTEM OPTION CHANGES button, then press ENTER. From the SHELF OPTIONS WILL BE CHANGED. CONTINUE (Y/N)? prompt, the following actions can be taken: <ul style="list-style-type: none"> To save the shelf options, press Y. The following events occur: <ul style="list-style-type: none"> all current values are set to desired values <div data-bbox="479 625 1239 1094" style="border: 1px solid black; padding: 5px; margin: 10px 0;"> <pre> PG-FlexPlus RT Line Unit MAIN PERFORMANCE ALARMS CONFIG TEST INFO System Options System Options Current Possible values Subscriber Test Response Mode : TA-909 (NONE, TA-909) PG-FlexPlus System ID (24 chars max) : PG-FlexPlus RT Auto Logout : DISABLED (DISABLED, 5, 30, 60) ACCEPT SYSTEM OPTION CHANGES SYSTEM OPTIONS WILL BE CHANGED. CONTINUE (Y/N)? █ 06/05/2002 SYSTEM ID: PG-FlexPlus 13:09:23 </pre> </div> <div data-bbox="479 1123 1239 1598" style="border: 1px solid black; padding: 5px; margin: 10px 0;"> <pre> PG-FlexPlus RT Line Unit MAIN PERFORMANCE ALARMS CONFIG TEST INFO System Options System Options Current Possible values Subscriber Test Response Mode : TA-909 (NONE, TA-909) PG-FlexPlus System ID (24 chars max) : PG-FlexPlus RT Auto Logout : DISABLED (DISABLED, 5, 30, 60) ACCEPT SYSTEM OPTION CHANGES SYSTEM OPTIONS HAVE BEEN CHANGED 06/05/2002 SYSTEM ID: PG-FlexPlus 13:09:51 </pre> </div> <ul style="list-style-type: none"> To retain the existing shelf options on the Shelf Options screen, press N.
4	<p>Press ESC. The Main Menu screen reappears.</p>

Table 13. Systems Options (Integrated)

System Options	Value	Description	Default
Subscriber Test Response Mode	NONE	Disables the test and there will be no response	TA-909
	TA-909	Performs the subscriber drop test at the RTLU and presents the TA-909 resistive signatures at the PMU-712	
PG-FlexPlus System ID (24 chars max)	24 Alphanumeric Characters maximum	Configurable identification string for the system can be up to 24 characters. The System ID is always visible at the bottom of every screen. There are no special rules for changing the System ID. Any printable characters including spaces are valid.	PG-FlexPlus
RT Auto Logout	DISABLED	Auto logout feature is disabled	DISABLED
	5	Screens session logs out after 5 minutes of inactivity	
	30	Screens session logs out after 30 minutes of inactivity	
	60	Screens session logs out after 60 minutes of inactivity	

Table 14. Systems Options (Universal)

System Options	Value	Description	Default
Subscriber Test Response Mode	NONE	Disables the test and there will be no response	TA-909
	BYPASS	Connects the subscriber to the CO, bypassing the System DLC	
	TA-909	Performs the subscriber drop test at the RTLU and presents the TA-909 resistive signatures at the PMU-712	
PG-FlexPlus System ID (24 chars max)	24 Alphanumeric Characters maximum	Configurable identification string for the system can be up to 24 characters. The System ID is always visible at the bottom of every screen. There are no special rules for changing the System ID. Any printable characters including spaces are valid.	PG-Flex
RT Auto Logout	DISABLED	Auto logout feature is disabled	DISABLED
	5	Screens session logs out after 5 minutes of inactivity	
	30	Screens session logs out after 30 minutes of inactivity	
	60	Screens session logs out after 60 minutes of inactivity	
COLU Auto Logout	DISABLED	Auto logout feature is disabled	DISABLED
	5	Screens session logs out after 5 minutes of inactivity	
	30	Screens session logs out after 30 minutes of inactivity	
	60	Screens session logs out after 60 minutes of inactivity	
Termination timeout – Metallic Access	OFF	Termination Timeout – Metallic Access is off	OFF
	30	Termination Timeout – Metallic Access times out after 30 minutes	
	60	Termination Timeout – Metallic Access times out after 60 minutes	
	120	Termination Timeout – Metallic Access times out after 120 minutes	

CONFIG — COLU System Alarm Type

The COLU System Alarm Types screen allows provisioning of all COLU system alarms. Table 16 on page 83 shows the COLU system alarms (Integrated setup) and Table 17 on page 84 shows the COLU system alarms (Universal setup). Table 15 on page 82 provides a description of the Alarm types reported.

CONFIG — COLU System Alarm Type

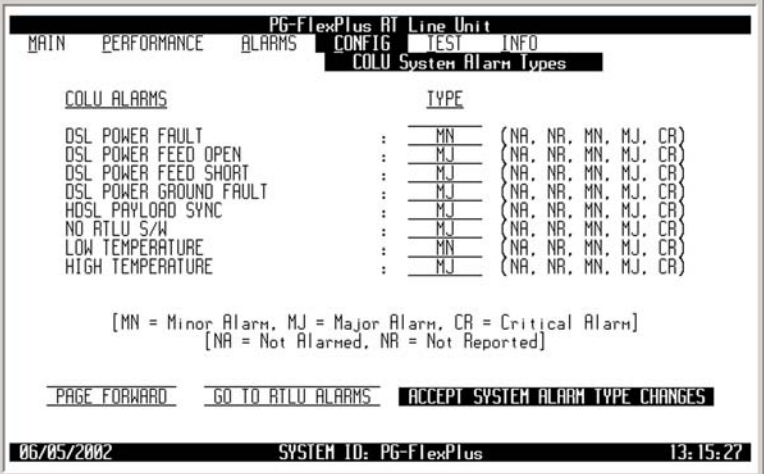
Step	Action
1	<p>At the Main Menu screen, select CONFIG. Press ↓ to choose COLU System Alarm Types. The following screen appears.</p>  <p>The screenshot shows a terminal window with the following content:</p> <pre> PG-FlexPlus AT Line Unit MAIN PERFORMANCE ALARMS CONFIG TEST INFO System Options COLU System Alarm Types ATLU System Alarm Types HDSL Alarm Thresholds HDSL Alarm Types ISDN Options ISDN Alarm Thresholds ISDN Alarm Types Channel Unit Alarm Types POTS Options LS/GS Options Set Factory Defaults Timeslot Configuration 06/05/2002 SYSTEM ID: PG-FlexPlus 13:10:27 </pre>
2	<p>Press ENTER. The following screen appears.</p>  <p>The screenshot shows a terminal window with the following content:</p> <pre> PG-FlexPlus AT Line Unit MAIN PERFORMANCE ALARMS CONFIG TEST INFO COLU System Alarm Types COLU ALARMS TYPE DSL POWER FAULT : MN (NA, NA, MN, MJ, CR) DSL POWER FEED OPEN : MJ (NA, NA, MN, MJ, CR) DSL POWER FEED SHORT : MJ (NA, NA, MN, MJ, CR) DSL POWER GROUND FAULT : MJ (NA, NA, MN, MJ, CR) HDSL PAYLOAD SYNC : MJ (NA, NA, MN, MJ, CR) NO ATLU S/W : MJ (NA, NA, MN, MJ, CR) LOW TEMPERATURE : MN (NA, NA, MN, MJ, CR) HIGH TEMPERATURE : MJ (NA, NA, MN, MJ, CR) [MN = Minor Alarm, MJ = Major Alarm, CR = Critical Alarm] [NA = Not Alarmed, NR = Not Reported] PAGE FORWARD GO TO ATLU ALARMS ACCEPT SYSTEM ALARM TYPE CHANGES 06/05/2002 SYSTEM ID: PG-FlexPlus 13:15:27 </pre>

CONFIG — COLU System Alarm Type (Continued)

Step	Action
3	<p>The following actions can be taken:</p> <ol style="list-style-type: none"> To change the field value, press SPACEBAR to toggle to the desired value, or press ↓ or ↑ to move to the next option. To scroll through the entire set of system alarms, select the PAGE FORWARD or PAGE BACKWARD button, then press ENTER. To view the RTLU alarm information, select the GO TO RTLU ALARMS button, then press ENTER. To save the COLU alarm type changes, select the ACCEPT SYSTEM ALARM TYPE CHANGES button, then press ENTER. From the SYSTEM ALARM TYPE CHANGES WILL BE CHANGED. CONTINUE (Y/N)? prompt, the following actions can be taken: <ul style="list-style-type: none"> To save the COLU alarm type changes, press Y. The following events occur: <ul style="list-style-type: none"> all current values are set to desired values
4	<p>Press ESC. The Main Menu screen reappears.</p>

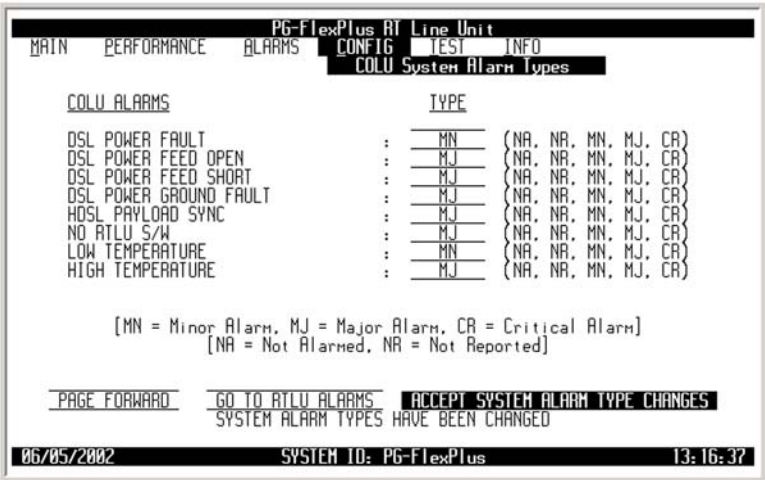
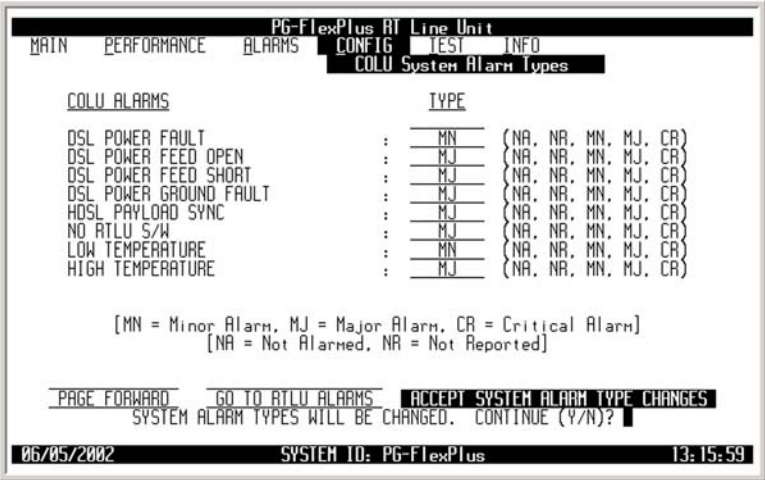

Table 15. Alarm Types Reported

Settings	Reported	Alarm LED Lit	Main Shelf Summary	History Updated
CR – Critical	Yes	Yes	Yes	Yes
MJ – Major	Yes	Yes	Yes	Yes
MN – Minor	Yes	Yes	Yes	Yes
NA – Not Alarmed	No	No	No	Yes
NR – Not Reported	No	No	No	No

Table 16. COLU Alarms (Integrated)

Alarm	Value	Description	Default
DSL POWER FAULT	CR, MJ, MN, NA, NR	DSL Power Fault	MN
DSL POWER FEED OPEN	CR, MJ, MN, NA, NR	COLU cannot power the RTLU due to an open circuit. A possible cause is that there is no RTLU at the other end of the circuit. No user intervention is required.	MJ
DSL POWER FEED SHORT	CR, MJ, MN, NA, NR	COLU cannot power the RTLU due to a short circuit. A PFS alarm indicates an overcurrent condition due to wire shorting or an RTLU failure. COLU automatically turns off power feeding both loops in response to a PFO or PFS condition on a single loop.	MJ
DSL POWER GROUND FAULT	CR, MJ, MN, NA, NR	Ground fault detected on HDSL loop	MJ
HDSL PAYLOAD SYNC	CR, MJ, MN, NA, NR	HDSL payload is out of synchronization	MJ
NO RTLU S/W	CR, MJ, MN, NA, NR	RTLU has no application software and is awaiting software download	MJ
LOW TEMPERATURE	CR, MJ, MN, NA, NR	Temperature at RTLU is too low	MN
HIGH TEMPERATURE	CR, MJ, MN, NA, NR	Temperature at RTLU is too high	MJ
EEPROM FAILURE	CR, MJ, MN, NA, NR	A checksum error has been detected on COLUs EEPROM data	MN
COLU-RTLU MISMATCH	CR, MJ, MN, NA, NR	Incompatible COLU and RTLUs installed, for example, an incompatible RTLU List Number is installed	MJ
CO BATTERY A	CR, MJ, MN, NA, NR	COLU detected missing A -48 V power source. If power is verified at the unit, then the unit must be replaced, because it has a blown fuse.	MN
CO BATTERY B	CR, MJ, MN, NA, NR	COLU detected missing B -48V power source. If power is verified at the unit, then the unit must be replaced, because it has a blown fuse.	MN
INVALID SLOT	CR, MJ, MN, NA, NR	RTCU installed in an invalid slot	MJ
MUX PARITY	CR, MJ, MN, NA, NR	Errors are detected between the COLU and the PMX	MJ

Table 17. COLU Alarms (Universal)

Alarm	Value	Description	Default
DSL POWER FAULT	CR, MJ, MN, NA, NR	DSL Power Fault	MN
DSL POWER FEED OPEN	CR, MJ, MN, NA, NR	COLU cannot power the RTLU due to an open circuit. A possible cause is that there is no RTLU at the other end of the circuit. No user intervention is required.	MJ
DSL POWER FEED SHORT	CR, MJ, MN, NA, NR	COLU cannot power the RTLU due to a short circuit. A PFS alarm indicates an overcurrent condition due to wire shorting or an RTLU failure. COLU automatically turns off power feeding both loops in response to a PFO or PFS condition on a single loop.	MJ
DSL POWER GROUND FAULT	CR, MJ, MN, NA, NR	Ground fault detected on HDSL loop	MJ
HDSL PAYLOAD SYNC	CR, MJ, MN, NA, NR	HDSL payload is out of synchronization	MJ
NO RTLU S/W	CR, MJ, MN, NA, NR	RTLU has no application software and is awaiting software download	MJ
LOW TEMPERATURE	CR, MJ, MN, NA, NR	Temperature at RTLU is too low	MN
HIGH TEMPERATURE	CR, MJ, MN, NA, NR	Temperature at RTLU is too high	MJ
EEPROM FAILURE	CR, MJ, MN, NA, NR	A checksum error has been detected on COLUs EEPROM data	MN
COLU-RTLU MISMATCH	CR, MJ, MN, NA, NR	Incompatible COLU and RTLUs installed, for example, an incompatible RTLU List Number is installed	MJ
INSUFFICIENT TIMESLOTS	CR, MJ, MN, NA, NR	Current channel unit configuration has insufficient timeslots (ISDN only)	MN
RTCUCONFIG MISMATCH	CR, MJ, MN, NA, NR	Incompatible COLU and RTCUs installed, for example, a POTS COCU is connected to an ISDN RTCU	MN
COMMON CARD ALARM	CR, MJ, MN, NA, NR	Common Card (PMU/PMX Card) is in alarm	MN

CONFIG — RTLU System Alarm Types

The RTLU System Alarm Types screen allows provisioning of all RTLU system alarms. Table 18 on page 87 shows the RTLU system alarm fields, values, descriptions and default settings. Table 15 on page 82 provides a description of the Alarm types reported.

CONFIG — RTLU System Alarm Types

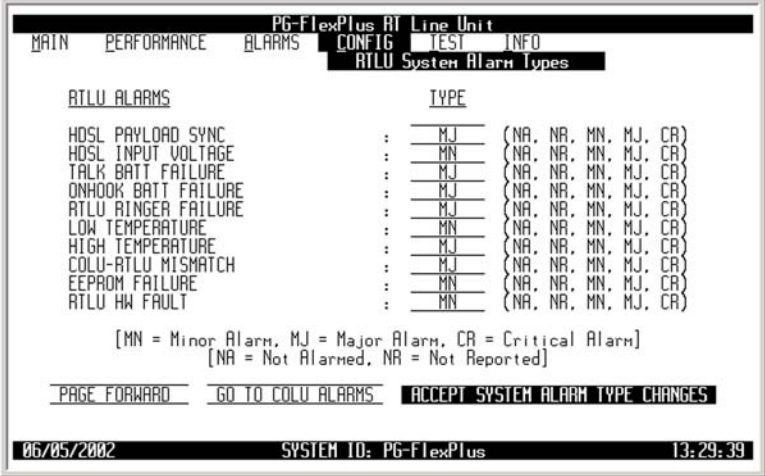
Step	Action																						
1	<p>At the Main Menu screen, select CONFIG. Press ↓ to choose RTLU System Alarm Types. The following screen appears.</p>  <p>The screenshot shows a terminal window with the following menu items: MAIN, PERFORMANCE, ALARMS, CONFIG (selected), TEST, INFO. Under CONFIG, the following options are listed: System Options, COLU System Alarm Types, RTLU System Alarm Types (highlighted), HDL Alarm Thresholds, HDL Alarm Types, ISDN Options, ISDN Alarm Thresholds, ISDN Alarm Types, Channel Unit Alarm Types, POTS Options, LS/GS Options, Set Factory Defaults, and Timeslot Configuration. The status bar at the bottom shows the date 06/05/2002, SYSTEM ID: PG-FlexPlus, and time 13:27:17.</p>																						
2	<p>Press ENTER. The following screen appears.</p>  <p>The screenshot shows the 'RTLU System Alarm Types' configuration screen. It displays a list of alarms and their types. The status bar at the bottom shows the date 06/05/2002, SYSTEM ID: PG-FlexPlus, and time 13:29:39.</p> <table border="1"> <thead> <tr> <th>RTLU ALARMS</th> <th>TYPE</th> </tr> </thead> <tbody> <tr> <td>HDSL PAYLOAD SYNC</td> <td>: MJ (NA, NA, MN, MJ, CR)</td> </tr> <tr> <td>HDSL INPUT VOLTAGE</td> <td>: MN (NA, NA, MN, MJ, CR)</td> </tr> <tr> <td>TALK BATT FAILURE</td> <td>: MJ (NA, NA, MN, MJ, CR)</td> </tr> <tr> <td>ONHOOK BATT FAILURE</td> <td>: MJ (NA, NA, MN, MJ, CR)</td> </tr> <tr> <td>RTLU RINGER FAILURE</td> <td>: MJ (NA, NA, MN, MJ, CR)</td> </tr> <tr> <td>LOW TEMPERATURE</td> <td>: MN (NA, NA, MN, MJ, CR)</td> </tr> <tr> <td>HIGH TEMPERATURE</td> <td>: MJ (NA, NA, MN, MJ, CR)</td> </tr> <tr> <td>COLU-RTLU MISMATCH</td> <td>: MJ (NA, NA, MN, MJ, CR)</td> </tr> <tr> <td>EEPROM FAILURE</td> <td>: MN (NA, NA, MN, MJ, CR)</td> </tr> <tr> <td>RTLU HW FAULT</td> <td>: MN (NA, NA, MN, MJ, CR)</td> </tr> </tbody> </table> <p>[MN = Minor Alarm, MJ = Major Alarm, CR = Critical Alarm] [NA = Not Alarmed, NR = Not Reported]</p> <p>PAGE FORWARD GO TO COLU ALARMS ACCEPT SYSTEM ALARM TYPE CHANGES</p>	RTLU ALARMS	TYPE	HDSL PAYLOAD SYNC	: MJ (NA, NA, MN, MJ, CR)	HDSL INPUT VOLTAGE	: MN (NA, NA, MN, MJ, CR)	TALK BATT FAILURE	: MJ (NA, NA, MN, MJ, CR)	ONHOOK BATT FAILURE	: MJ (NA, NA, MN, MJ, CR)	RTLU RINGER FAILURE	: MJ (NA, NA, MN, MJ, CR)	LOW TEMPERATURE	: MN (NA, NA, MN, MJ, CR)	HIGH TEMPERATURE	: MJ (NA, NA, MN, MJ, CR)	COLU-RTLU MISMATCH	: MJ (NA, NA, MN, MJ, CR)	EEPROM FAILURE	: MN (NA, NA, MN, MJ, CR)	RTLU HW FAULT	: MN (NA, NA, MN, MJ, CR)
RTLU ALARMS	TYPE																						
HDSL PAYLOAD SYNC	: MJ (NA, NA, MN, MJ, CR)																						
HDSL INPUT VOLTAGE	: MN (NA, NA, MN, MJ, CR)																						
TALK BATT FAILURE	: MJ (NA, NA, MN, MJ, CR)																						
ONHOOK BATT FAILURE	: MJ (NA, NA, MN, MJ, CR)																						
RTLU RINGER FAILURE	: MJ (NA, NA, MN, MJ, CR)																						
LOW TEMPERATURE	: MN (NA, NA, MN, MJ, CR)																						
HIGH TEMPERATURE	: MJ (NA, NA, MN, MJ, CR)																						
COLU-RTLU MISMATCH	: MJ (NA, NA, MN, MJ, CR)																						
EEPROM FAILURE	: MN (NA, NA, MN, MJ, CR)																						
RTLU HW FAULT	: MN (NA, NA, MN, MJ, CR)																						

CONFIG — RTLU System Alarm Types (Continued)

Step	Action
3	<p>The following actions can be taken:</p> <ol style="list-style-type: none"> To change the field value, press SPACEBAR to toggle to the desired value, or press ↓ or ↑ to move to the next option. To scroll through the entire set of system alarms, select the PAGE FORWARD or PAGE BACKWARD button, then press ENTER. To view the COLU alarm information, select the GO TO COLU ALARMS button, then press ENTER. To save the RTLU alarm type changes, select the ACCEPT SYSTEM ALARM TYPE CHANGES button, then press ENTER. From the SYSTEM ALARM TYPE CHANGES WILL BE CHANGED. CONTINUE (Y/N)? prompt, the following actions can be taken: <ul style="list-style-type: none"> To save the RTLU alarm type changes, press Y. The following events occur: <ul style="list-style-type: none"> – all current values are set to desired values <div data-bbox="479 743 1239 1213" style="border: 1px solid black; padding: 5px; margin: 10px 0;"> <pre> PG-FlexPlus RT Line Unit MAIN PERFORMANCE ALARMS CONFIG TEST INFO RTLU System Alarm Types RTLU ALARMS TYPE HDSL PAYLOAD SYNC : MJ (NA, NA, MN, MJ, CR) HDSL INPUT VOLTAGE : MN (NA, NA, MN, MJ, CR) TALK BATT FAILURE : MJ (NA, NA, MN, MJ, CR) ONHOOK BATT FAILURE : MJ (NA, NA, MN, MJ, CR) RTLU RINGER FAILURE : MJ (NA, NA, MN, MJ, CR) LOW TEMPERATURE : MN (NA, NA, MN, MJ, CR) HIGH TEMPERATURE : MJ (NA, NA, MN, MJ, CR) COLU-RTLU MISMATCH : MJ (NA, NA, MN, MJ, CR) EEPROM FAILURE : MN (NA, NA, MN, MJ, CR) RTLU HW FAULT : MN (NA, NA, MN, MJ, CR) [MN = Minor Alarm, MJ = Major Alarm, CR = Critical Alarm] [NA = Not Alarmed, NA = Not Reported] PAGE FORWARD GO TO COLU ALARMS ACCEPT SYSTEM ALARM TYPE CHANGES SYSTEM ALARM TYPES WILL BE CHANGED. CONTINUE (Y/N)? 06/05/2002 SYSTEM ID: PG-FlexPlus 13:38:13 </pre> </div> <div data-bbox="479 1249 1239 1722" style="border: 1px solid black; padding: 5px; margin: 10px 0;"> <pre> PG-FlexPlus RT Line Unit MAIN PERFORMANCE ALARMS CONFIG TEST INFO RTLU System Alarm Types RTLU ALARMS TYPE HDSL PAYLOAD SYNC : MJ (NA, NA, MN, MJ, CR) HDSL INPUT VOLTAGE : MN (NA, NA, MN, MJ, CR) TALK BATT FAILURE : MJ (NA, NA, MN, MJ, CR) ONHOOK BATT FAILURE : MJ (NA, NA, MN, MJ, CR) RTLU RINGER FAILURE : MJ (NA, NA, MN, MJ, CR) LOW TEMPERATURE : MN (NA, NA, MN, MJ, CR) HIGH TEMPERATURE : MJ (NA, NA, MN, MJ, CR) COLU-RTLU MISMATCH : MJ (NA, NA, MN, MJ, CR) EEPROM FAILURE : MN (NA, NA, MN, MJ, CR) RTLU HW FAULT : MN (NA, NA, MN, MJ, CR) [MN = Minor Alarm, MJ = Major Alarm, CR = Critical Alarm] [NA = Not Alarmed, NA = Not Reported] PAGE FORWARD GO TO COLU ALARMS ACCEPT SYSTEM ALARM TYPE CHANGES SYSTEM ALARM TYPES HAVE BEEN CHANGED 06/05/2002 SYSTEM ID: PG-FlexPlus 13:38:45 </pre> </div> <ul style="list-style-type: none"> To retain the existing RTLU alarm types, press N.
4	<p>Press ESC. The Main Menu screen reappears.</p>



Table 18. RTLU Alarms

Alarms	Value	Description	Default
HDSL PAYLOAD SYNC	CR, MJ, MN, NA, NR	HDSL payload is out of sync	MJ
HDSL INPUT VOLTAGE	CR, MJ, MN, NA, NR	Detects an insufficient HDSL input voltage level	MN
TALK BATT FAILURE	CR, MJ, MN, NA, NR	Talk battery failure at RTLU	MJ
ONHOOK BATT FAILURE	CR, MJ, MN, NA, NR	On-hook battery failure at RTLU	MJ
RTL U RINGER FAILURE	CR, MJ, MN, NA, NR	RT ringer failure at RTLU	MJ
LOW TEMPERATURE	CR, MJ, MN, NA, NR	Temperature at RTLU is too low	MN
HIGH TEMPERATURE	CR, MJ, MN, NA, NR	Temperature at RTLU is too high	MJ
COLU-RTL U MISMATCH	CR, MJ, MN, NA, NR	COLU-RTL U mismatch	MJ
EEPROM FAILURE	CR, MJ, MN, NA, NR	COLU memory checksum is incorrect	MN
RTL U HW FAULT	CR, MJ, MN, NA, NR	Fault detected in RTLU hardware	MN
RT EXTERNAL ALARM 1	CR, MJ, MN, NA, NR	RT External 1 Alarm reported	MN
RT EXTERNAL ALARM 2	CR, MJ, MN, NA, NR	RT External 2 Alarm reported	MN
RT EXTERNAL ALARM 3	CR, MJ, MN, NA, NR	RT External 3 Alarm reported	MN
RT EXTERNAL ALARM 4	CR, MJ, MN, NA, NR	RT External 4 Alarm reported	MN
FAN FAILURE	CR, MJ, MN, NA, NR	Fan Unit has failed	MN

CONFIG — HDSL Alarm Thresholds

This screen allows the provisioning of the threshold crossing values for the 15 minute and 24-hour ES and UAS counts and HDSL margin. [Table 19 on page 90](#) shows the HDSL Alarm Threshold fields, values, descriptions and default settings.

CONFIG — HDSL Alarm Thresholds

Step	Action												
1	<p>At the Main Menu screen, select CONFIG. Press ↓ to choose HDSL Alarm Thresholds. The following screen appears.</p>  <p>The screenshot shows a terminal window with the following menu items: MAIN, PERFORMANCE, ALARMS, CONFIG (selected), TEST, INFO. Under CONFIG, the following options are listed: System Options, COLU System Alarm Types, RTLU System Alarm Types, HDSL Alarm Thresholds (highlighted), HDSL Alarm Types, ISDN Options, ISDN Alarm Thresholds, ISDN Alarm Types, Channel Unit Alarm Types, POTS Options, LS/OS Options, Set Factory Defaults, and Timeslot Configuration. The status bar at the bottom shows the date 06/05/2002, SYSTEM ID: PG-FlexPlus, and time 13:31:19.</p>												
2	<p>Press ENTER. The following screen appears.</p>  <p>The screenshot shows the 'HDSL Alarm Thresholds' configuration screen. It has a header with MAIN, PERFORMANCE, ALARMS, CONFIG (selected), TEST, INFO. Below the header, the title 'HDSL Alarm Thresholds' is displayed. The screen is divided into two columns: 'HDSL ALARMS' and 'THRESHOLD'. The data is as follows:</p> <table border="1"> <thead> <tr> <th>HDSL ALARMS</th> <th>THRESHOLD</th> </tr> </thead> <tbody> <tr> <td>HDSL ES 15 MIN</td> <td>: 017 (0...900)</td> </tr> <tr> <td>HDSL ES 24 HR</td> <td>: 00170 (0...65000)</td> </tr> <tr> <td>HDSL UAS 15 MIN</td> <td>: 240 (0...900)</td> </tr> <tr> <td>HDSL UAS 24 HR</td> <td>: 00600 (0...65000)</td> </tr> <tr> <td>HDSL LOW MARGIN</td> <td>: 06 (0...15)</td> </tr> </tbody> </table> <p>At the bottom of the screen, there is a button labeled 'ACCEPT HDSL ALARM THRESHOLD CHANGES'. The status bar at the bottom shows the date 06/05/2002, SYSTEM ID: PG-FlexPlus, and time 13:32:27.</p>	HDSL ALARMS	THRESHOLD	HDSL ES 15 MIN	: 017 (0...900)	HDSL ES 24 HR	: 00170 (0...65000)	HDSL UAS 15 MIN	: 240 (0...900)	HDSL UAS 24 HR	: 00600 (0...65000)	HDSL LOW MARGIN	: 06 (0...15)
HDSL ALARMS	THRESHOLD												
HDSL ES 15 MIN	: 017 (0...900)												
HDSL ES 24 HR	: 00170 (0...65000)												
HDSL UAS 15 MIN	: 240 (0...900)												
HDSL UAS 24 HR	: 00600 (0...65000)												
HDSL LOW MARGIN	: 06 (0...15)												

CONFIG — HDSL Alarm Thresholds (Continued)

Step	Action
3	<p>The following actions can be taken:</p> <ol style="list-style-type: none"> To change the threshold value, press ↓ or ↑ to go to the appropriate HDSL Alarm Threshold. Then type the appropriate numbers on the keypad for each field. To save the HDSL Alarm Threshold changes, select the ACCEPT HDSL ALARM THRESHOLD CHANGES button, then press ENTER. From the HDSL ALARM THRESHOLDS WILL BE CHANGED. CONTINUE (Y/N)? prompt, the following actions can be taken: <ul style="list-style-type: none"> To save the HDSL Alarm Threshold changes, press Y. The following events occur: <ul style="list-style-type: none"> – all current values are set to desired values <div data-bbox="479 640 1242 1117" style="border: 1px solid black; padding: 5px; margin: 10px 0;"> <pre> PG-FlexPlus AT Line Unit MAIN PERFORMANCE ALARMS CONFIG TEST INFO HDSL Alarm Thresholds HDSL ALARMS THRESHOLD HDSL ES 15 MIN : 017 (0...900) HDSL ES 24 HR : 00170 (0...65000) HDSL UAS 15 MIN : 240 (0...900) HDSL UAS 24 HR : 00600 (0...65000) HDSL LOW MARGIN : 06 (0...15) ACCEPT HDSL ALARM THRESHOLD CHANGES HDSL ALARM THRESHOLDS WILL BE CHANGED. CONTINUE (Y/N)? █ 06/05/2002 SYSTEM ID: PG-FlexPlus 13:32:57 </pre> </div> <div data-bbox="479 1150 1242 1627" style="border: 1px solid black; padding: 5px; margin: 10px 0;"> <pre> PG-FlexPlus AT Line Unit MAIN PERFORMANCE ALARMS CONFIG TEST INFO HDSL Alarm Thresholds HDSL ALARMS THRESHOLD HDSL ES 15 MIN : 017 (0...900) HDSL ES 24 HR : 00170 (0...65000) HDSL UAS 15 MIN : 240 (0...900) HDSL UAS 24 HR : 00600 (0...65000) HDSL LOW MARGIN : 06 (0...15) ACCEPT HDSL ALARM THRESHOLD CHANGES HDSL ALARM THRESHOLDS HAVE BEEN CHANGED 06/05/2002 SYSTEM ID: PG-FlexPlus 13:33:37 </pre> </div> <ul style="list-style-type: none"> To retain the existing HDSL Alarm Thresholds, press N.
4	<p>Press ESC. The Main Menu screen reappears.</p>

Table 19. HDSL Alarm Thresholds

Alarms	Value	Description	Default
HDSL ES 15 MIN	0 to 900	HDSL ES 15 minutes alarm is generated if the current 15-minute HDSL ES count reaches or exceeds this threshold	17
HDSL ES 24 HOUR	0 to 65,000	HDSL ES 24 hour alarm is generated if ES 24 hour counts become equal to or greater than this threshold	170
HDSL UAS 15 MIN	0 to 900	HDSL UAS-15 minutes alarm is generated in the current 15-minute HDSL UAS count reaches or exceeds this threshold	240
HDSL UAS 24 HR	0 to 65,000	HDSL UAS-24 hour alarm is generated if UAS counts become equal to or greater than this threshold	600
HDSL LOW MARGIN	0 to 15	HDSL Low Margin alarm is generated if margin drops equal to or less than this threshold	6

CONFIG — HDSL Alarm Types

This screen allows provisioning of the alarm types for all HDSL alarms. [Table 20 on page 93](#) lists the HDSL Alarm Type fields, values, descriptions and default settings.

CONFIG — HDSL Alarm Types

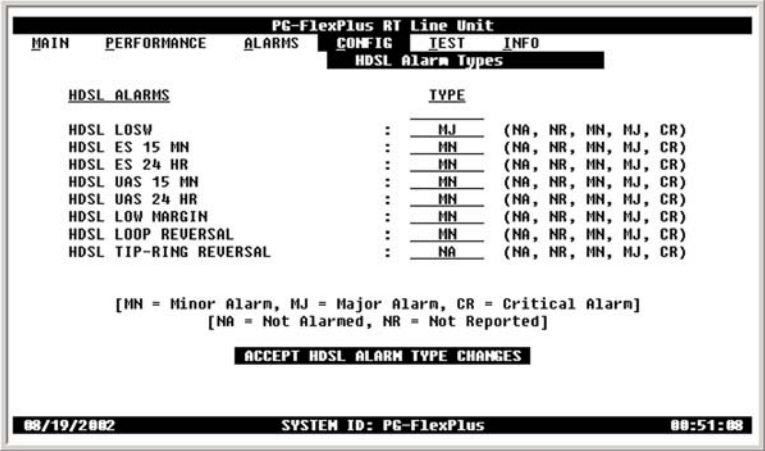
Step	Action
1	<p>At the Main Menu screen, select CONFIG. Press ↓ to choose HDSL Alarm Types. The following screen appears.</p>  <p>The screenshot shows a terminal window with the following content:</p> <pre> PG-FlexPlus RT Line Unit MAIN PERFORMANCE ALARMS CONFIG TEST INFO System Options COLU System Alarm Types ATLU System Alarm Types HDSL Alarm Thresholds HDSL Alarm Types ISON Options ISON Alarm Thresholds ISON Alarm Types Channel Unit Alarm Types POTS Options LS/GS Options Set Factory Defaults Timeslot Configuration 06/05/2002 SYSTEM ID: PG-FlexPlus 13:34:11 </pre>
2	<p>Press ENTER. The following screen appears.</p>  <p>The screenshot shows a terminal window with the following content:</p> <pre> PG-FlexPlus RT Line Unit MAIN PERFORMANCE ALARMS CONFIG TEST INFO HDSL Alarm Types HDSL ALARMS TYPE HDSL LOSW : MJ (NA, NR, MN, MJ, CR) HDSL ES 15 MN : MN (NA, NR, MN, MJ, CR) HDSL ES 24 HR : MN (NA, NR, MN, MJ, CR) HDSL UAS 15 MN : MN (NA, NR, MN, MJ, CR) HDSL UAS 24 HR : MN (NA, NR, MN, MJ, CR) HDSL LOW MARGIN : MN (NA, NR, MN, MJ, CR) HDSL LOOP REVERSAL : MN (NA, NR, MN, MJ, CR) HDSL TIP-RING REVERSAL : NA (NA, NR, MN, MJ, CR) [MN = Minor Alarm, MJ = Major Alarm, CR = Critical Alarm] [NA = Not Alarmed, NR = Not Reported] ACCEPT HDSL ALARM TYPE CHANGES 08/19/2002 SYSTEM ID: PG-FlexPlus 08:51:08 </pre>

CONFIG — HDSL Alarm Types (Continued)

Step	Action
3	<p>The following actions can be taken:</p> <ol style="list-style-type: none"> To change the field value, press SPACEBAR to toggle to the desired value, or press ↓ or ↑ to move to the next option. To save the HDSL Alarm Type changes, select the ACCEPT HDSL ALARM TYPE CHANGES button, then press ENTER. From the HDSL ALARM TYPES WILL BE CHANGED. CONTINUE (Y/N)? prompt, the following actions can be taken: <ul style="list-style-type: none"> To save the HDSL Alarm Types changes, press Y. The following events occur: <ul style="list-style-type: none"> – all current values are set to desired values <div data-bbox="480 657 1239 1104" style="border: 1px solid black; padding: 5px; margin: 10px 0;"> <pre> PC-FlexPlus RT Line Unit MAIN PERFORMANCE ALARMS CONFIG TEST INFO HDSL Alarm Types HDSL ALARMS TYPE HDSL LOSW : MJ (NA, NR, MN, MJ, CR) HDSL ES 15 MN : MN (NA, NR, MN, MJ, CR) HDSL ES 24 HR : MN (NA, NR, MN, MJ, CR) HDSL UAS 15 MN : MN (NA, NR, MN, MJ, CR) HDSL UAS 24 HR : MN (NA, NR, MN, MJ, CR) HDSL LOW MARGIN : MN (NA, NR, MN, MJ, CR) HDSL LOOP REVERSAL : MN (NA, NR, MN, MJ, CR) HDSL TIP-RING REVERSAL : NA (NA, NR, MN, MJ, CR) [MN = Minor Alarm, MJ = Major Alarm, CR = Critical Alarm] [NA = Not Alarmed, NR = Not Reported] ACCEPT HDSL ALARM TYPE CHANGES HDSL ALARM TYPES WILL BE CHANGED. CONTINUE (Y/N)? 08/19/2002 SYSTEM ID: PC-FlexPlus 08:52:08 </pre> </div> <div data-bbox="480 1163 1239 1610" style="border: 1px solid black; padding: 5px; margin: 10px 0;"> <pre> PC-FlexPlus RT Line Unit MAIN PERFORMANCE ALARMS CONFIG TEST INFO HDSL Alarm Types HDSL ALARMS TYPE HDSL LOSW : MJ (NA, NR, MN, MJ, CR) HDSL ES 15 MN : MN (NA, NR, MN, MJ, CR) HDSL ES 24 HR : MN (NA, NR, MN, MJ, CR) HDSL UAS 15 MN : MN (NA, NR, MN, MJ, CR) HDSL UAS 24 HR : MN (NA, NR, MN, MJ, CR) HDSL LOW MARGIN : MN (NA, NR, MN, MJ, CR) HDSL LOOP REVERSAL : MN (NA, NR, MN, MJ, CR) HDSL TIP-RING REVERSAL : NA (NA, NR, MN, MJ, CR) [MN = Minor Alarm, MJ = Major Alarm, CR = Critical Alarm] [NA = Not Alarmed, NR = Not Reported] ACCEPT HDSL ALARM TYPE CHANGES HDSL ALARM TYPES HAVE BEEN CHANGED 08/19/2002 SYSTEM ID: PC-FlexPlus 08:52:48 </pre> </div> <ul style="list-style-type: none"> To retain the existing HDSL Alarm Types, press N.
4	<p>Press ESC. The Main Menu screen reappears.</p>



Table 20. HDSL Alarm Types

Alarms	Value	Description	Default
HDSL LOSW	CR, MJ, MN, NA, NR	HDSL Loop has lost synchronization	MJ
HDSL ES 15 MN	CR, MJ, MN, NA, NR	HDSL ES 15 minute alarm is generated if the current 15 minute HDSL ES count reaches or exceeds this threshold	MN
HDSL ES 24 HR	CR, MJ, MN, NA, NR	HDSL ES 24 hour alarm is generated if the HDSL ES 24 hour count reaches or exceeds this threshold	MN
HDSL UAS 15 MN	CR, MJ, MN, NA, NR	HDSL UAS 15 minute alarm is generated if the current 15-minute HDSL UAS count reaches or exceeds this threshold	MN
HDSL UAS 24 HR	CR, MJ, MN, NA, NR	HDSL UAS 24 hour alarm is generated if the HDSL UAS 24-hour count reaches or exceeds this threshold	MN
HDSL LOW MARGIN	CR, MJ, MN, NA, NR	HDSL low margin alarm is generated if the margin is equal to, or less than, this threshold	MN
HDSL LOOP REVERSAL	CR, MJ, MN, NA, NR	HDSL loops A and B are reversed on the span	MN
HDSL TIP-RING REVERSAL	CR, MJ, MN, NA, NR	HDSL tip-ring of the HDSL A or B loop is reversed on the span	NA

CONFIG — ISDN Options

This screen allows provisioning of ISDN options. Table 21 on page 96 lists the ISDN Option fields, values, descriptions and default settings.

CONFIG — ISDN Options

Step	Action
1	<p>At the Main Menu screen, select CONFIG. Press ↓ to choose ISDN Options. The following screen appears.</p>  <p>The screenshot shows a terminal window with a menu structure. At the top, it says 'PG-FlexPlus AT Line Unit'. Below that are menu items: 'MAIN', 'PERFORMANCE', 'ALARMS', 'CONFIG', 'TEST', and 'INFO'. 'CONFIG' is selected. A sub-menu is displayed with options: 'System Options', 'COLU System Alarm Types', 'ATLU System Alarm Types', 'HDSL Alarm Thresholds', 'HDSL Alarm Types', 'ISDN Options' (highlighted), 'ISDN Alarm Thresholds', 'ISDN Alarm Types', 'Channel Unit Alarm Types', 'POTS Options', 'LS/GS Options', 'Set Factory Defaults', and 'Timeslot Configuration'. At the bottom, it shows '06/05/2002', 'SYSTEM ID: PG-FlexPlus', and '13:37:17'.</p>
2	<p>Press ENTER. The following screen appears.</p>  <p>The screenshot shows the 'ISDN Options' screen. At the top, it says 'PG-FlexPlus AT Line Unit'. Below that are menu items: 'MAIN', 'PERFORMANCE', 'ALARMS', 'CONFIG', 'TEST', and 'INFO'. 'CONFIG' is selected, and 'ISDN Options' is highlighted. The screen displays 'Select ISDN Channel:' followed by four options: 'CU1 (ISDN4): CHANNEL1', 'CU2 (POT68): CHANNEL2', 'CU3 (POT68): CHANNEL3', and 'CU4 (EMPTY): CHANNEL4'. At the bottom, it shows '06/05/2002', 'SYSTEM ID: PG-FlexPlus', and '13:37:55'.</p> <p>To view the ISDN option data, select the ISDN channel, then press ENTER.</p>

CONFIG — ISDN Options (Continued)

Step	Action
3	<p>The following actions can be taken:</p> <ol style="list-style-type: none"> To change the field value, press SPACEBAR to toggle to the desired value, or press ↓ or ↑ to move to the next option. To save the ISDN Option changes, select the ACCEPT ISDN OPTION CHANGES button, then press ENTER. From the ISDN OPTIONS WILL BE CHANGED. CONTINUE (Y/N)? prompt, the following actions can be taken: <ul style="list-style-type: none"> To save the ISDN Option changes, press Y. The following events occur: <ul style="list-style-type: none"> all current values are set to desired values <div data-bbox="480 636 1239 1108" style="border: 1px solid black; padding: 5px; margin: 10px 0;"> <pre> PG-FlexPlus RT Line Unit MAIN PERFORMANCE ALARMS CONFIG TEST INFO ISDN Options CU: 1 CH: 1 ISDN Options Current Possible values Sealing Current : ON (OFF, ON) EOC Mode : MP-EOC-SLAVE (MP-EOC-SLAVE, TRANSPARENT) SES Count : 3 (1..15) PM Mode : INTERIM PATH (INTERIM PATH, SEGMENTED PATH) B Channel Swap : NORMAL (NORMAL, SWAP) Zero Byte Substitution : DISABLE (DISABLE, ENABLE) PM Clock Mode : AUTO (AUTO, MANUAL) PM Clock Source (Manual Mode): PG-FLEXPLUS (PG-FLEXPLUS, ISDN SWITCH) ACCEPT ISDN OPTION CHANGES 06/05/2002 SYSTEM ID: PG-FlexPlus 13:38:49 </pre> </div> <div data-bbox="480 1129 1239 1602" style="border: 1px solid black; padding: 5px; margin: 10px 0;"> <pre> PG-FlexPlus RT Line Unit MAIN PERFORMANCE ALARMS CONFIG TEST INFO ISDN Options CU: 1 CH: 1 ISDN Options Current Possible values Sealing Current : ON (OFF, ON) EOC Mode : MP-EOC-SLAVE (MP-EOC-SLAVE, TRANSPARENT) SES Count : 3 (1..15) PM Mode : INTERIM PATH (INTERIM PATH, SEGMENTED PATH) B Channel Swap : NORMAL (NORMAL, SWAP) Zero Byte Substitution : DISABLE (DISABLE, ENABLE) PM Clock Mode : AUTO (AUTO, MANUAL) PM Clock Source (Manual Mode): PG-FLEXPLUS (PG-FLEXPLUS, ISDN SWITCH) ACCEPT ISDN OPTION CHANGES ISDN OPTIONS WILL BE CHANGED. CONTINUE (Y/N)? █ 06/05/2002 SYSTEM ID: PG-FlexPlus 13:39:23 </pre> </div> <ul style="list-style-type: none"> To retain the existing ISDN Options, press N.
4	<p>Press ESC. The Main Menu screen reappears.</p>

Table 21. ISDN Options

System Options	Value	Description	Default
Sealing Current	OFF	No sealing current is applied to the ISDN subscriber loop	ON
	ON	Constant current of approximately 5 MA flows in the ISDN subscriber loop at all time	
EOC Mode	MP-EOC-SLAVE	EOC messages are decoded and re-transmitted within the system	MP-EOC-SLAVE
	TRANSPARENT	EOC messages are not decoded and are passed through the system transparently	
SES Count	1 to 15	Number of ISDN BE allowed before SES count is incremented	3
PM Mode	INTERIM PATH	Considers the channel as one path and collects the end-to-end error rate for the entire transport path	INTERIM PATH
	SEGMENTED PATH	Considers the channel as separate sections and individually collects error rates for each DSL loop	
B Channel Swap	NORMAL	Channels "B1" and "B2" at the CO ISDN "U" interface are routed to channels "B1" and "B2" at the RT ISDN "U" interface	NORMAL
	SWAP	Channels "B1" and "B2" at the CO ISDN "U" interface are routed to channels "B2" and "B1" at the RT ISDN "U" interface	
Zero Byte Substitution	DISABLE	System passes all data through without any special encoding	DISABLE
	ENABLE	System uses a ZBS code to prevent long string of zeros in the data	
PM Clock Mode	AUTO	"0" byte of the channel unit determines the PM Clock Source field	AUTO
	MANUAL	Clock source is determined by PM Clock Source field	
PM Clock Source (Manual Mode)	PG-FLEXPLUS	Clock source is determined by system clock	PG-FLEXPLUS
	ISDN SWITCH	Clock source is determined by ISDN clock	

CONFIG — ISDN Alarm Thresholds

This screen allows the provisioning of ISDN alarm thresholds. The fields on this screen are measured hourly and daily. [Table 22 on page 99](#) lists the ISDN Alarm Threshold fields, values, descriptions and default settings.

CONFIG — ISDN Alarm Thresholds

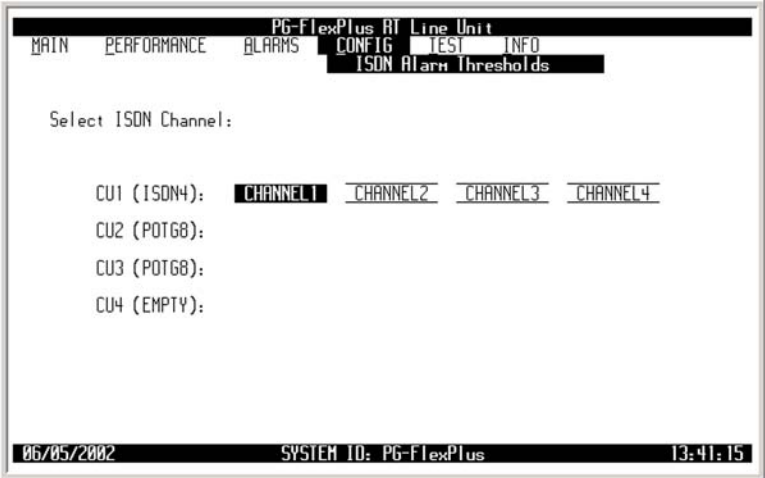
Step	Action
1	<p>At the Main Menu screen, select CONFIG. Press ↓ to choose ISDN Alarm Thresholds. The following screen appears.</p>  <p>The screenshot shows a terminal window with a menu structure. At the top, it says 'PG-FlexPlus AT Line Unit'. Below that are tabs for 'MAIN', 'PERFORMANCE', 'ALARMS', 'CONFIG', 'TEST', and 'INFO'. Under 'CONFIG', several options are listed: 'System Options', 'COLU System Alarm Types', 'ATLU System Alarm Types', 'HDSL Alarm Thresholds', 'HDSL Alarm Types', 'ISDN Options', 'ISDN Alarm Thresholds' (highlighted), 'ISDN Alarm Types', 'Channel Unit Alarm Types', 'POTS Options', 'LS/GS Options', 'Set Factory Defaults', and 'Timeslot Configuration'. At the bottom of the terminal, it displays '06/05/2002', 'SYSTEM ID: PG-FlexPlus', and '13:40:33'.</p>
2	<p>Press ENTER. The following screen appears.</p>  <p>The screenshot shows the 'ISDN Alarm Thresholds' configuration screen. At the top, it says 'PG-FlexPlus AT Line Unit'. Below that are tabs for 'MAIN', 'PERFORMANCE', 'ALARMS', 'CONFIG', 'TEST', and 'INFO'. Under 'CONFIG', 'ISDN Alarm Thresholds' is selected. The screen prompts 'Select ISDN Channel:'. Below this, there are four options: 'CU1 (ISDN4):', 'CU2 (POT68):', 'CU3 (POT68):', and 'CU4 (EMPTY):'. Each option has a corresponding channel name in a box: 'CHANNEL1', 'CHANNEL2', 'CHANNEL3', and 'CHANNEL4'. At the bottom of the terminal, it displays '06/05/2002', 'SYSTEM ID: PG-FlexPlus', and '13:41:15'.</p> <p>To view the ISDN alarm threshold data, select the ISDN channel, then press ENTER.</p>

CONFIG — ISDN Alarm Thresholds (Continued)

Step	Action
3	<p>The following actions can be taken:</p> <ol style="list-style-type: none"> To change the threshold value, press ↓ or ↑ to go to the appropriate ISDN Alarm Threshold. Then type the appropriate numbers on the keypad for each field. To save the ISDN Alarm Threshold changes, select the ACCEPT ISDN THRESHOLD CHANGES button, then press ENTER. From the ISDN THRESHOLDS WILL BE CHANGED. CONTINUE (Y/N)? prompt, the following actions can be taken: <ul style="list-style-type: none"> To save the ISDN Alarm Threshold changes, press Y. The following events occur: <ul style="list-style-type: none"> all current values are set to desired values <div style="text-align: center;">  </div> <div style="text-align: center;">  </div> <ul style="list-style-type: none"> To retain the existing ISDN Alarm Thresholds, press N.
4	<p>Press ESC. The Main Menu screen reappears.</p>



Table 22. ISDN Alarm Thresholds

Alarms	Value	Description	Default
HOURLY ES	1 to 255	ISDN hourly ES alarm is generated if the accumulated hourly ES count at the COLU/RTLU reaches or exceeds this threshold	40
DAILY ES	1 to 4095	ISDN daily ES alarm is generated if the accumulated daily ES count at the COLU/RTLU reaches or exceeds this threshold	100
HOURLY SES	1 to 127	ISDN hourly SES alarm is generated if the accumulated hourly SES count at the COLU/RTLU reaches or exceeds this threshold	10
DAILY SES	0 to 2047	ISDN daily SES alarm is generated if the accumulated daily SES count at the COLU/RTLU reaches or exceeds this threshold	25

CONFIG — ISDN Alarm Types

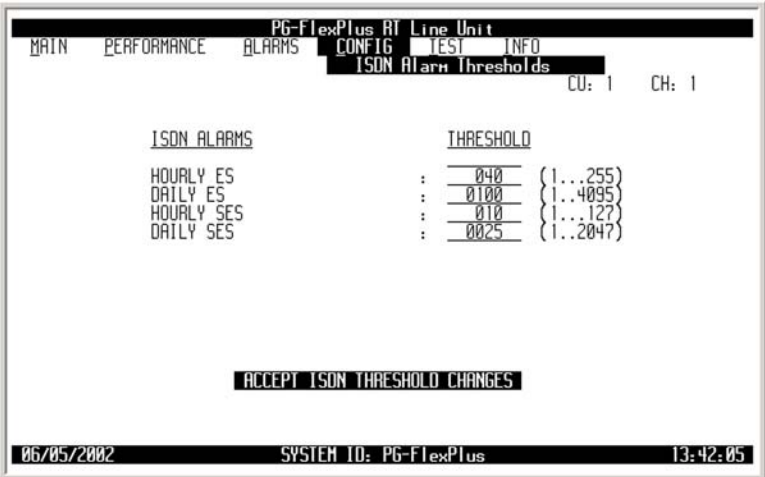
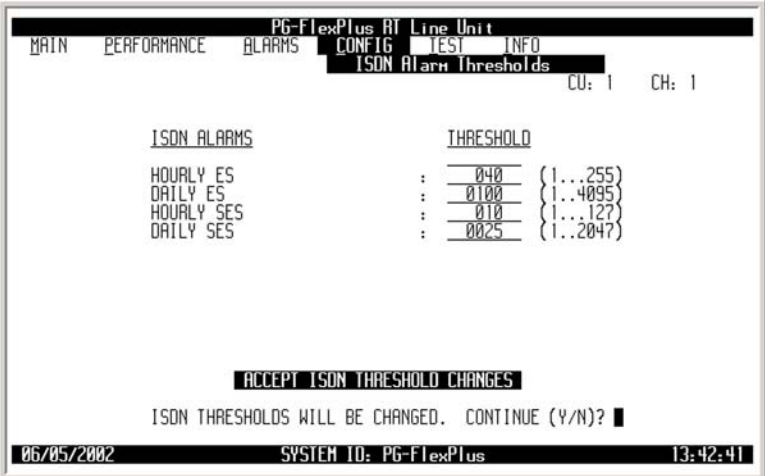
This screen allows the provisioning of ISDN alarm types. Table 23 on page 102 lists the ISDN Alarm Type fields, values, descriptions and default settings.

CONFIG — ISDN Alarm Types

Step	Action
1	<p>At the Main Menu screen, select CONFIG. Press ↓ to choose ISDN Alarm Types. The following screen appears.</p>  <p>The screenshot shows a terminal window with a menu. At the top, it says 'PG-FlexPlus AT Line Unit'. Below that are tabs for 'MAIN', 'PERFORMANCE', 'ALARMS', 'CONFIG', 'TEST', and 'INFO'. The 'CONFIG' tab is active. A list of options is shown: 'System Options', 'COLU System Alarm Types', 'ATLU System Alarm Types', 'HDSL Alarm Thresholds', 'HDSL Alarm Types', 'ISDN Options', 'ISDN Alarm Thresholds', 'ISDN Alarm Types' (highlighted), 'Channel Unit Alarm Types', 'POTS Options', 'LS/GS Options', 'Set Factory Defaults', and 'Timeslot Configuration'. At the bottom, it shows '06/05/2002', 'SYSTEM ID: PG-FlexPlus', and '13:43:49'.</p>
2	<p>Press ENTER. The following screen appears.</p>  <p>The screenshot shows a terminal window with the title 'PG-FlexPlus AT Line Unit'. Below the title are tabs for 'MAIN', 'PERFORMANCE', 'ALARMS', 'CONFIG', 'TEST', and 'INFO'. The 'CONFIG' tab is active, and 'ISDN Alarm Types' is selected. The screen displays 'Select ISDN Channel:' followed by four options: 'CU1 (ISDN4): CHANNEL1', 'CU2 (POT68):', 'CU3 (POT68):', and 'CU4 (EMPTY):'. The 'CHANNEL1' option is highlighted. At the bottom, it shows '06/05/2002', 'SYSTEM ID: PG-FlexPlus', and '13:44:31'.</p> <p>To view the ISDN alarm type data, select the ISDN channel, then press ENTER.</p>

CONFIG — ISDN Alarm Types (Continued)

Step	Action
3	<p>The following actions can be taken:</p> <ol style="list-style-type: none"> To change the field value, press SPACEBAR to toggle to the desired value, or press ↓ or ↑ to move to the next option. To save the ISDN Alarm Type changes, select the ACCEPT ISDN ALARM TYPE CHANGES button, then press ENTER. From the ISDN ALARM TYPES WILL BE CHANGED. CONTINUE (Y/N)? prompt, the following actions can be taken: <ul style="list-style-type: none"> To save the ISDN Alarm Type changes, press Y. The following events occur: <ul style="list-style-type: none"> – all current values are set to desired values
4	<p>Press ESC. The Main Menu screen reappears.</p>

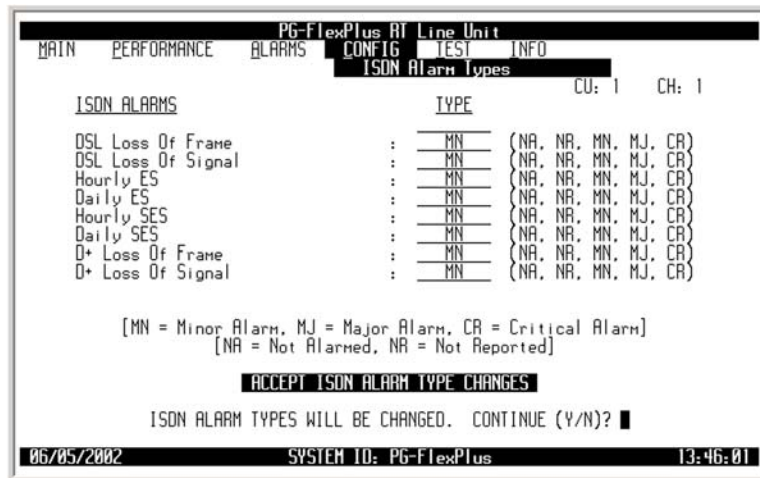
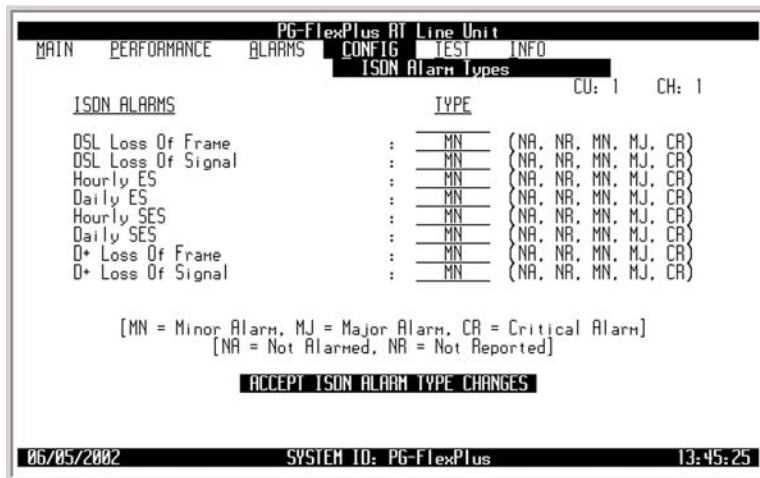

- To retain the existing ISDN Alarm Types, press **N**.

Table 23. ISDN Alarm Types

Alarms	Value	Description	Default
DSL Loss Of Frame	CR, MJ, MN, NA, NR	Generated if there is a DSL Loss of Frame	MN
DSL Loss Of Signal	CR, MJ, MN, NA, NR	Generated if there is a DSL Loss of Signal	MN
HOURLY ES	CR, MJ, MN, NA, NR	Generated if the accumulated hourly ES count at the COLU/RTLU reaches or exceeds its threshold value. A single threshold value is used for threshold errors in the customer or network direction.	MN
DAILY ES	CR, MJ, MN, NA, NR	Generated if the accumulated daily ES count at the COLU/RTLU reaches or exceeds its threshold value. A single threshold value is used for threshold errors in the customer or network direction.	MN
HOURLY SES	CR, MJ, MN, NA, NR	Generated if the accumulated hourly SES count at the COLU/RTLU reaches or exceeds its threshold value. A single threshold value is used for threshold errors in the customer or network direction.	MN
DAILY SES	CR, MJ, MN, NA, NR	Generated if the accumulated daily SES count at the COLU/RTLU reaches or exceeds its threshold value. A single threshold value is used for threshold errors in the customer or network direction.	MN
D+ Loss of Frame	CR, MJ, MN, NA, NR	Generated if the ISDN m-channel framing pattern has been lost on the HDSL link	MN
D+ Loss of Signal	CR, MJ, MN, NA, NR	Generated if the ISDN m-channel loses synchronization	MN

CONFIG — Channel Unit Alarm Types

This screen allows provisioning of channel unit alarms types. Each RT channel unit continuously monitors its subscriber ring generator circuits. If a ring generator circuit fails, the subscriber's equipment no longer rings. When an RT channel unit detects the failure of one of these circuits, it generates an alarm of the severity selected on this screen. [Table 24 on page 105](#) lists the Channel Unit Alarm Type fields, values, descriptions and default settings.

CONFIG — Channel Unit Alarm Types

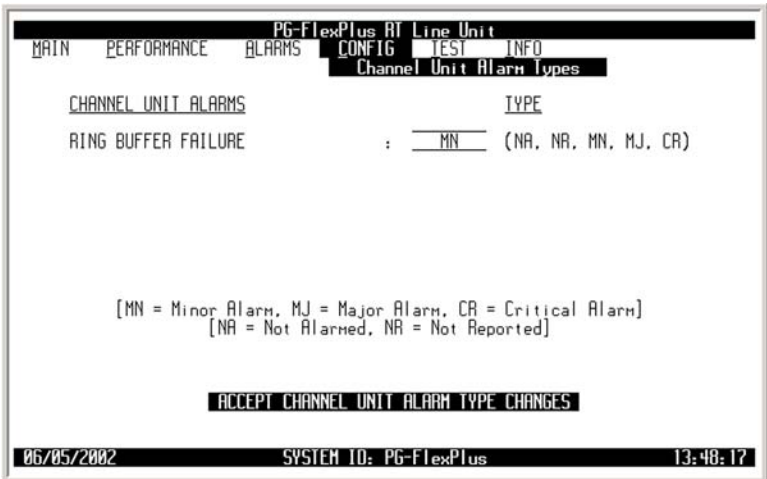
Step	Action
1	<p>At the Main Menu screen, select CONFIG. Press ↓ to choose Channel Unit Alarm Types. The following screen appears.</p>  <p>The screenshot shows a terminal window with a menu. At the top, it says 'PG-FlexPlus RT Line Unit'. Below that are tabs for 'MAIN', 'PERFORMANCE', 'ALARMS', 'CONFIG', 'TEST', and 'INFO'. The 'CONFIG' tab is active, and a list of options is shown: 'System Options', 'COLU System Alarm Types', 'ATLU System Alarm Types', 'HDSL Alarm Thresholds', 'HDSL Alarm Types', 'ISDN Options', 'ISDN Alarm Thresholds', 'ISDN Alarm Types', 'Channel Unit Alarm Types' (highlighted), 'POTS Options', 'LS/GS Options', 'Set Factory Defaults', and 'Timeslot Configuration'. At the bottom, it displays '06/05/2002', 'SYSTEM ID: PG-FlexPlus', and '13:47:25'.</p>
2	<p>Press ENTER. The following screen appears.</p>  <p>The screenshot shows the 'Channel Unit Alarm Types' configuration screen. At the top, it says 'PG-FlexPlus RT Line Unit'. Below that are tabs for 'MAIN', 'PERFORMANCE', 'ALARMS', 'CONFIG', 'TEST', and 'INFO'. The 'CONFIG' tab is active, and the title 'Channel Unit Alarm Types' is displayed. The screen shows a table with two columns: 'CHANNEL UNIT ALARMS' and 'TYPE'. The first row is 'RING BUFFER FAILURE' with a value of 'MN' and '(NA, NA, MN, MJ, CR)'. Below the table, there is a legend: '[MN = Minor Alarm, MJ = Major Alarm, CR = Critical Alarm]' and '[NA = Not Alarmed, NR = Not Reported]'. At the bottom, there is a button labeled 'ACCEPT CHANNEL UNIT ALARM TYPE CHANGES'. At the bottom of the terminal window, it displays '06/05/2002', 'SYSTEM ID: PG-FlexPlus', and '13:48:17'.</p>

CONFIG — Channel Unit Alarm Types (Continued)

Step	Action
3	<p>The following actions can be taken:</p> <ol style="list-style-type: none"> To change the Ring Buffer Failure field value, press SPACEBAR to toggle to the desired value. To save the Channel Unit Alarm Type changes, select the ACCEPT CHANNEL UNIT ALARM TYPE CHANGES button, then press ENTER. From the CHANNEL UNIT ALARM TYPES WILL BE CHANGED. CONTINUE (Y/N)? prompt, the following actions can be taken: <ul style="list-style-type: none"> To save the Channel Unit Alarm Type changes, press Y. The following events occur: <ul style="list-style-type: none"> – all current values are set to desired values <div data-bbox="479 613 1239 1087" style="border: 1px solid black; padding: 5px; margin: 10px 0;"> <pre> PG-FlexPlus AT Line Unit MAIN PERFORMANCE ALARMS CONFIG TEST INFO Channel Unit Alarm Types CHANNEL UNIT ALARMS TYPE RING BUFFER FAILURE : MN (NA, NA, MN, MJ, CR) [MN = Minor Alarm, MJ = Major Alarm, CR = Critical Alarm] [NA = Not Alarmed, NA = Not Reported] ACCEPT CHANNEL UNIT ALARM TYPE CHANGES CHANNEL UNIT ALARM TYPES WILL BE CHANGED. CONTINUE (Y/N)? █ 06/05/2002 SYSTEM ID: PG-FlexPlus 13:48:53 </pre> </div> <div data-bbox="479 1117 1239 1591" style="border: 1px solid black; padding: 5px; margin: 10px 0;"> <pre> PG-FlexPlus AT Line Unit MAIN PERFORMANCE ALARMS CONFIG TEST INFO Channel Unit Alarm Types CHANNEL UNIT ALARMS TYPE RING BUFFER FAILURE : MN (NA, NA, MN, MJ, CR) [MN = Minor Alarm, MJ = Major Alarm, CR = Critical Alarm] [NA = Not Alarmed, NA = Not Reported] ACCEPT CHANNEL UNIT ALARM TYPE CHANGES CHANNEL UNIT ALARM TYPES HAVE BEEN CHANGED 06/05/2002 SYSTEM ID: PG-FlexPlus 13:49:27 </pre> </div> <ul style="list-style-type: none"> To retain the existing Channel Unit Alarm Types, press N.
4	<p>Press ESC. The Main Menu screen reappears.</p>

Table 24. Channel Unit Alarms

Alarms	Value	Description	Default
RTCU 1 RING BUFFER FAILURE	CR, MJ, MN, NA, NR	RTLU has detected a ring buffer failure on RTCU1. Associated CU must be replaced to restore ringing functionality.	MN
RTCU 2 RING BUFFER FAILURE	CR, MJ, MN, NA, NR	RTLU has detected a ring buffer failure on RTCU2. Associated CU must be replaced to restore ringing functionality.	MN
RTCU 3 RING BUFFER FAILURE	CR, MJ, MN, NA, NR	RTLU has detected a ring buffer failure on RTCU3. Associated CU must be replaced to restore ringing functionality.	MN
RTCU 4 RING BUFFER FAILURE	CR, MJ, MN, NA, NR	RTLU has detected a ring buffer failure on RTCU4. Associated CU must be replaced to restore ringing functionality.	MN

CONFIG — POTS Options

This screen allows provisioning of POTS lines. [Table 25 on page 108](#) lists the POTS Option fields, values, descriptions and default settings.

CONFIG — POTS Options

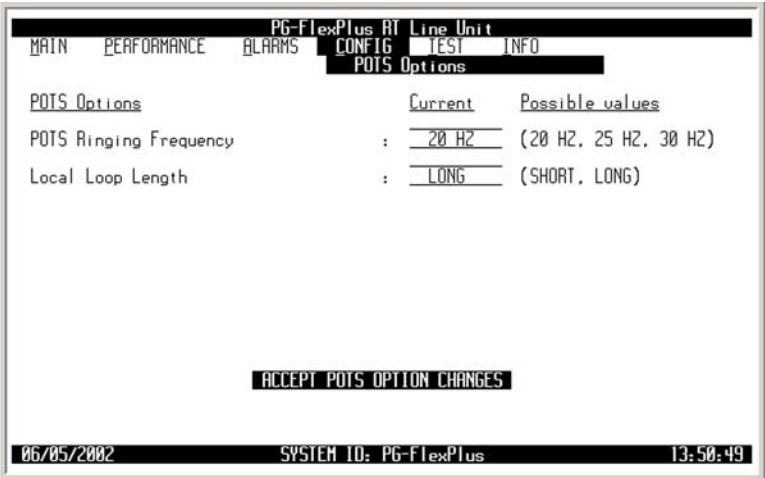
Step	Action
1	<p>At the Main Menu screen, select CONFIG. Press ↓ to choose POTS Options. The following screen appears.</p>  <p>The screenshot shows a terminal window with a menu structure. At the top, it says 'PG-FlexPlus RT Line Unit'. Below that are tabs for 'MAIN', 'PERFORMANCE', 'ALARMS', 'CONFIG', 'TEST', and 'INFO'. The 'CONFIG' tab is active, and a list of options is shown: 'System Options', 'COLU System Alarm Types', 'ATLU System Alarm Types', 'HOSL Alarm Thresholds', 'HOSL Alarm Types', 'ISDN Options', 'ISDN Alarm Thresholds', 'ISDN Alarm Types', and 'Channel Unit Alarm Types'. 'POTS Options' is highlighted with a black bar. Below the list are 'LS/OS Options', 'Set Factory Defaults', and 'Timeslot Configuration'. At the bottom of the screen, it displays '06/05/2002', 'SYSTEM ID: PG-FlexPlus', and '13:49:59'.</p>
2	<p>Press ENTER. The following screen appears.</p>  <p>The screenshot shows the 'POTS Options' configuration screen. At the top, it says 'PG-FlexPlus RT Line Unit'. Below that are tabs for 'MAIN', 'PERFORMANCE', 'ALARMS', 'CONFIG', 'TEST', and 'INFO'. The 'CONFIG' tab is active, and 'POTS Options' is highlighted. Below that, there are two fields: 'POTS Ringing Frequency' with a current value of '20 HZ' and possible values '(20 HZ, 25 HZ, 30 HZ)', and 'Local Loop Length' with a current value of 'LONG' and possible values '(SHORT, LONG)'. At the bottom of the screen, it displays '06/05/2002', 'SYSTEM ID: PG-FlexPlus', and '13:50:49'. A black bar at the bottom of the screen contains the text 'ACCEPT POTS OPTION CHANGES'.</p>

CONFIG — POTS Options (Continued)

Step	Action
3	<p>The following actions can be taken:</p> <ul style="list-style-type: none"> a. To change the POTS Ringing Frequency field value, press SPACEBAR to toggle to the desired value. b. To change the Local Loop Length field value, press SPACEBAR to toggle to the desired value. c. To save the POTS Option changes, select the ACCEPT POTS OPTION CHANGES button, then press ENTER. From the POTS OPTIONS WILL BE CHANGED. CONTINUE (Y/N)? prompt, the following actions can be taken: <ul style="list-style-type: none"> • To save the POTS Option changes, press Y. The following events occur: <ul style="list-style-type: none"> – all current values are set to desired values <div style="border: 1px solid black; padding: 5px; margin: 10px 0;"> <pre> PG-FlexPlus RT Line Unit MAIN PERFORMANCE ALARMS CONFIG TEST INFO POTS Options POTS Options Current Possible values POTS Ringing Frequency : 20 HZ (20 HZ, 25 HZ, 30 HZ) Local Loop Length : LONG (SHORT, LONG) ACCEPT POTS OPTION CHANGES POTS OPTIONS WILL BE CHANGED. CONTINUE (Y/N)? █ 06/05/2002 SYSTEM ID: PG-FlexPlus 13:51:23 </pre> </div> <div style="border: 1px solid black; padding: 5px; margin: 10px 0;"> <pre> PG-FlexPlus RT Line Unit MAIN PERFORMANCE ALARMS CONFIG TEST INFO POTS Options POTS Options Current Possible values POTS Ringing Frequency : 20 HZ (20 HZ, 25 HZ, 30 HZ) Local Loop Length : LONG (SHORT, LONG) ACCEPT POTS OPTION CHANGES POTS OPTIONS HAVE BEEN CHANGED 06/05/2002 SYSTEM ID: PG-FlexPlus 13:51:51 </pre> </div> <ul style="list-style-type: none"> • To retain the existing POTS Options, press N.
4	<p>Press ESC. The Main Menu screen reappears.</p>

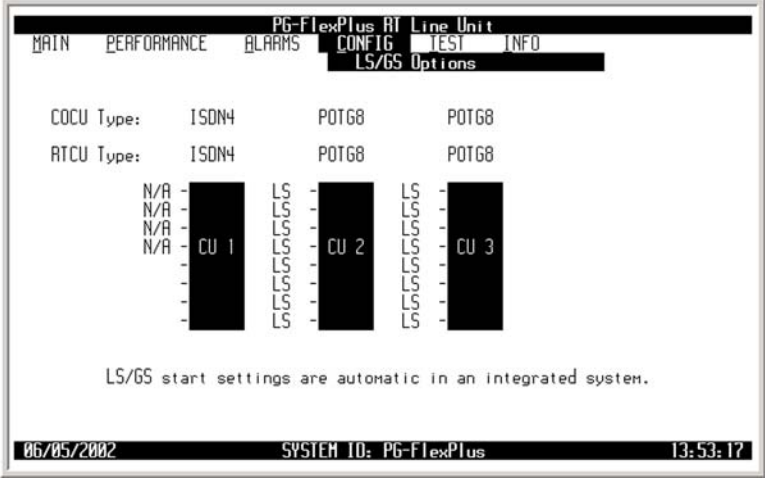

Table 25. POTS Options

Alarm	Value	Description	Default
POTS Ringing Frequency	20 HZ 25 HZ 30 HZ	Sets the ring generator frequency for all POTS circuits served by the COLU or 3 RTLUs	20 HZ
Local Loop Length	SHORT	All POTS circuits support short subscriber drops and results in slightly reduced power consumption from the CO battery	LONG
	LONG	All POTS circuits support standard length subscriber drops. The power consumption from the CO battery matches the published specifications	

CONFIG — LS/GS Options (Integrated)

This screen shows the Loop Start and Ground Start configuration (Integrated setup).



CONFIG — LS/GS Options (Integrated)

Step	Action
1	<p>At the Main Menu screen, select CONFIG. Press ↓ to choose LS/GS Options. The following screen appears.</p>  <p>The screenshot shows a terminal window with a menu structure. At the top, it says 'PG-FlexPlus AT Line Unit'. Below that are tabs for 'MAIN', 'PERFORMANCE', 'ALARMS', 'CONFIG', 'TEST', and 'INFO'. The 'CONFIG' menu is expanded to show options: 'System Options', 'COLU System Alarm Types', 'ATLU System Alarm Types', 'HDSL Alarm Thresholds', 'HDSL Alarm Types', 'ISDN Options', 'ISDN Alarm Thresholds', 'ISDN Alarm Types', 'Channel Unit Alarm Types', 'POTS Options', and 'LS/GS Options' (which is highlighted). Below these are 'Set Factory Defaults' and 'Timeslot Configuration'. At the bottom of the terminal, it shows '06/05/2002', 'SYSTEM ID: PG-FlexPlus', and '13:52:33'.</p>
2	<p>Press ENTER. The following screen appears.</p>  <p>The screenshot shows the 'LS/GS Options' configuration screen. At the top, it says 'PG-FlexPlus AT Line Unit' and 'LS/GS Options'. Below that, it shows 'COCU Type:' and 'ATCU Type:' both set to 'ISDN4'. There are three columns for channel units: 'CU 1', 'CU 2', and 'CU 3'. Each column has a 'LS' label and a 'GS' label, both with a '█' symbol next to them, indicating they are active. Below the configuration, it says 'LS/GS start settings are automatic in an integrated system.' At the bottom of the terminal, it shows '06/05/2002', 'SYSTEM ID: PG-FlexPlus', and '13:53:17'.</p> <p> Only POTS channel units indicate LS/GS. ISDN channel units always display N/A.</p>
3	<p>Press ESC. The Main Menu screen reappears.</p>

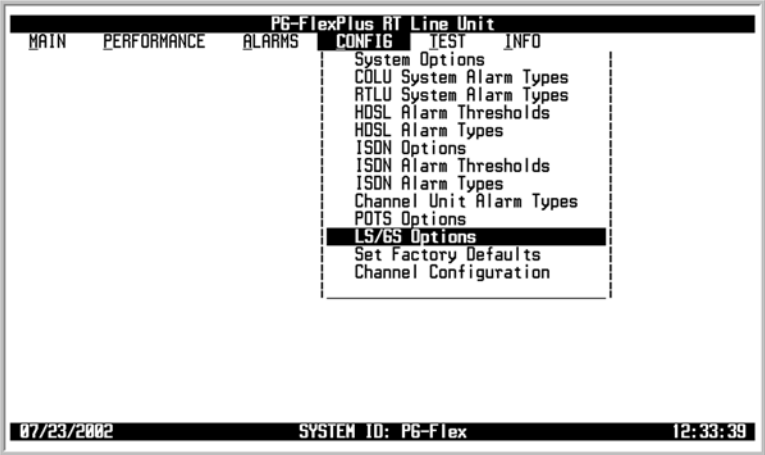
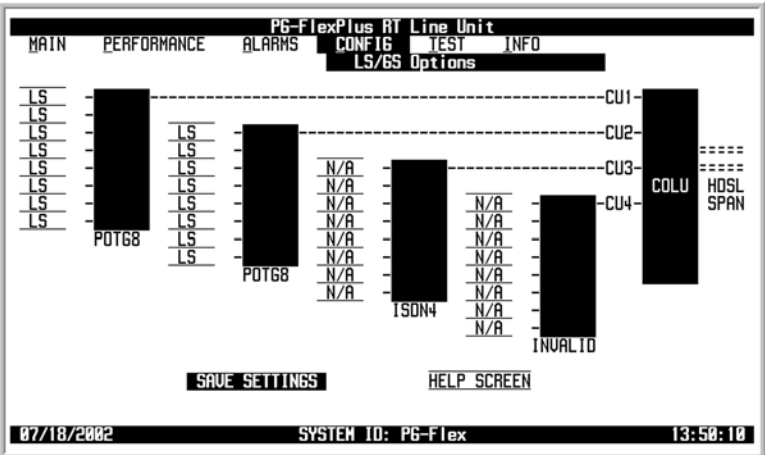

CONFIG — LS/GS Options (Universal)

This screen shows the Loop Start and Ground Start configuration (Universal setup).

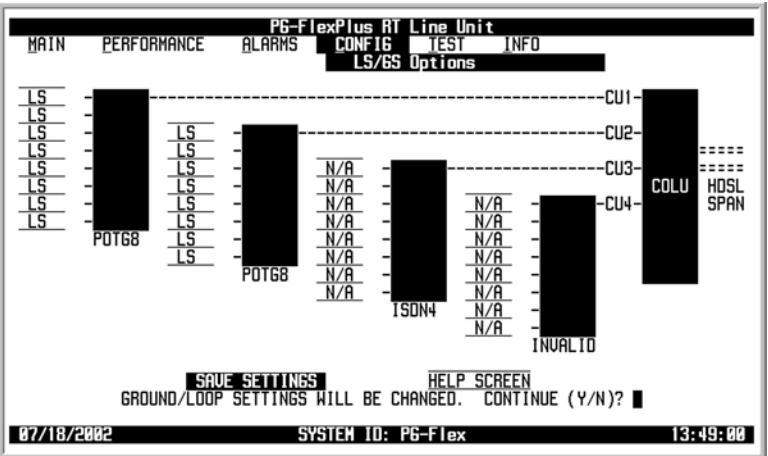
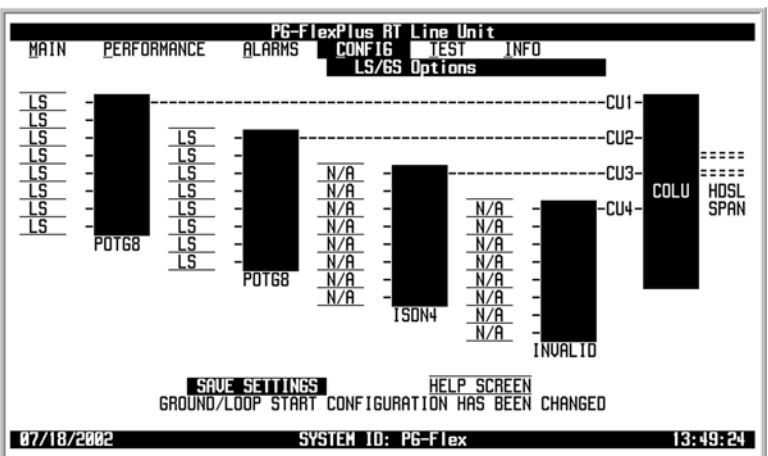

CONFIG — LS/GS Options (Universal)

Step	Action
1	<p>At the Main Menu screen, select CONFIG. Press ↓ to choose LS/GS Options. The following screen appears.</p>  <p>The screenshot shows a terminal window titled "PG-FlexPlus RT Line Unit". The menu options are: MAIN, PERFORMANCE, ALARMS, CONFIG (selected), TEST, INFO. The configuration list includes: System Options, COLU System Alarm Types, RTLU System Alarm Types, HOSL Alarm Thresholds, HOSL Alarm Types, ISDN Options, ISDN Alarm Thresholds, ISDN Alarm Types, Channel Unit Alarm Types, POTS Options, and LS/GS Options (highlighted). Below this are "Set Factory Defaults" and "Channel Configuration". The status bar at the bottom shows "07/23/2002", "SYSTEM ID: PG-Flex", and "12:33:39".</p>
2	<p>Press ENTER. The following screen appears.</p>  <p>The screenshot shows the "LS/GS Options" configuration screen. It displays a grid of channel units. On the left, there are two columns of "POT68" units, each with 8 "LS" indicators. In the middle, there are two columns of "ISDN4" units, each with 8 "N/A" indicators. On the right, there are four "COLU" units labeled "CU1", "CU2", "CU3", and "CU4". "CU1" and "CU2" have "LS" indicators, while "CU3" and "CU4" have "HOSL SPAN" indicators. At the bottom, there are "SAVE SETTINGS" and "HELP SCREEN" buttons. The status bar at the bottom shows "07/18/2002", "SYSTEM ID: PG-Flex", and "13:50:10".</p> <p> Only POTS channel units indicate LS/GS. ISDN channel units always display N/A.</p>

CONFIG — LS/GS Options (Universal) (Continued)

Step	Action
3	<p>The following actions can be taken:</p> <ol style="list-style-type: none"> To change the field value, press SPACEBAR to toggle to the desired value, or press ↓, ↑, ← or → to move to next option. To save the LS/GS Option changes, select the SAVE SETTINGS button, then press ENTER. From the GROUND/LOOP SETTINGS WILL BE CHANGED. CONTINUE (Y/N)? prompt, the following actions can be taken: <ul style="list-style-type: none"> To save the LS/GS Option changes, press Y. The following events occur: <ul style="list-style-type: none"> all current values are set to desired values <div style="text-align: center;">  </div> <div style="text-align: center;">  </div> <p> Only POTS channel units indicate LS/GS. ISDN channel units always display N/A.</p> <ul style="list-style-type: none"> To retain the existing POTS Options, press N.

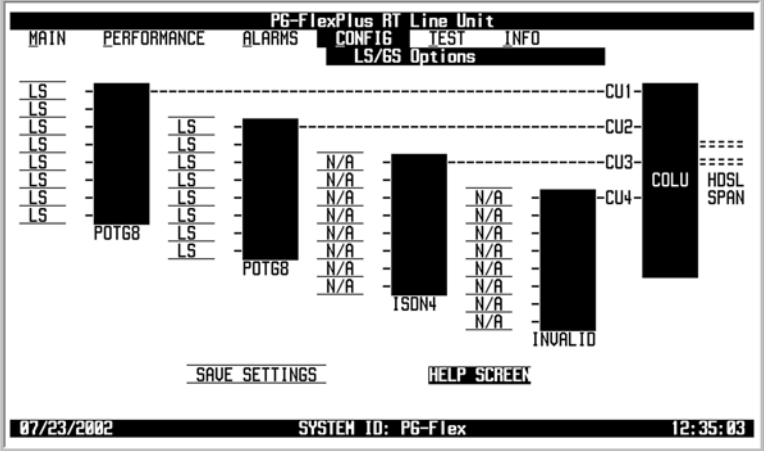

CONFIG — LS/GS Options (Universal) (Continued)

Step	Action
4	<p>To view the Help Screen, select the HELP SCREEN button, then press ENTER. The Help Screen appears.</p> <div style="text-align: center;">   </div>
5	<p>Press ESC. The Main Menu screen reappears.</p>

CONFIG — Set Factory Defaults

This screen resets the configuration data back to the original factory default setting.

CONFIG — Set Factory Defaults

Step	Action
1	<p>At the Main Menu screen, select CONFIG. Press ↓ to choose Set Factory Defaults. The following screen appears.</p>  <p>The screenshot shows a terminal window with a menu structure. At the top, it says 'PG-FlexPlus RT Line Unit'. Below that are tabs for 'MAIN', 'PERFORMANCE', 'ALARMS', 'CONFIG', 'TEST', and 'INFO'. The 'CONFIG' menu is expanded, listing several options: 'System Options', 'COLU System Alarm Types', 'ATLU System Alarm Types', 'HDSL Alarm Thresholds', 'HDSL Alarm Types', 'ISDN Options', 'ISDN Alarm Thresholds', 'ISDN Alarm Types', 'Channel Unit Alarm Types', 'POTS Options', and 'LS/GS Options'. The option 'Set Factory Defaults' is highlighted with a black bar. At the bottom of the terminal window, it displays '06/05/2002', 'SYSTEM ID: PG-FlexPlus', and '13:57:09'.</p>
2	<p>Press ENTER. The following screen appears.</p>  <p>The screenshot shows a terminal window with the same menu structure as the previous one. The 'CONFIG' menu is expanded, and 'Set Factory Defaults' is highlighted. Below the menu, the text reads: 'CONFIGURATION DATA WILL BE SET TO FACTORY DEFAULTS (THIS MAY BE SERVICE AFFECTING!) CONTINUE (Y/N)?'. At the bottom of the terminal window, it displays '06/05/2002', 'SYSTEM ID: PG-FlexPlus', and '13:57:57'.</p> <p>CAUTION <i>Setting to Factory Defaults may cause a loss of service.</i></p>

CONFIG — Set Factory Defaults (Continued)

Step	Action
3	<p>The following actions can be taken:</p> <p>a. To reset the system options back to the original factor default settings, press ENTER. From the CONFIGURATION DATA WILL BE SET TO FACTORY DEFAULTS (THIS MAY BE SERVICE AFFECTING!) CONTINUE (Y/N)? prompt, the following actions can be taken:</p> <ul style="list-style-type: none"> • To save the Factory Default changes, press Y. The following events occur: <ul style="list-style-type: none"> – all current values are reset to the factory default values <div data-bbox="477 575 1240 1052" style="border: 1px solid black; padding: 10px; margin: 10px auto; width: fit-content;"> <pre> PG-FLexPlus AT Line Unit MAIN PERFORMANCE ALARMS CONFIG TEST INFO CONFIGURATION DATA HAS BEEN SET TO FACTORY DEFAULTS PRESS <ESC> TO CONTINUE 06/05/2002 SYSTEM ID: PG-FLexPlus 13:58:33 </pre> </div> <ul style="list-style-type: none"> • To retain the existing configuration data, press N.
4	<p>Press ESC. The Main Menu screen reappears.</p>

CONFIG — Timeslot Configuration (Integrated)

This screen allows mapping of a timeslot to a specific channel within a channel unit (Integrated setup). [Table 26 on page 118](#) lists the Timeslot Configuration fields, values, descriptions and default settings.

Timeslot Mapping

The system supports 24 timeslots (DS0s) that can be mapped for subscriber services. The POTS services require one timeslot per circuit and ISDN services require three timeslots per circuit. When the system initially powers up, the Timeslot Configuration screen displays "POTG8" channel units installed in CU1, CU2, and CU3, regardless of what channel units are actually installed in these slots.

After the COLU and RTLU have achieved synchronization:

- CU4 indicates EMPTY if an FRE-86x RT enclosure is used
- CU4 indicates POTG8 if an FRE-765 RT enclosure is used

After the COLU and RTLU have achieved synchronization, the actual card types installed in the RT enclosure are displayed.

CONFIG — Timeslot Configuration (Integrated)

Step	Action
1	<p>At the Main Menu screen, select CONFIG. Press ↓ to choose Timeslot Configuration. The following screen appears.</p> 

CONFIG — Timeslot Configuration (Integrated) (Continued)

Step	Action
2	Press ENTER . The following screen appears.

```

PG-FlexPlus RT Line Unit
MAIN PERFORMANCE ALARMS CONFIG TEST INFO
Timeslot Configuration
CU1: TSON4 CU2: POTG8 CU3: POTG8 CU4: EMPTY
-----
Timeslot Enable CU# CH# SUB-CH# Timeslot Enable CU# CH# SUB-CH#
1 ON 1 1 B1 13 ON 2 5 NA
2 ON 1 1 B2 14 ON 2 6 NA
3 ON 1 1 0 15 ON 2 7 NA
4 ON 1 2 B1 16 ON 2 8 NA
5 ON 1 2 B2 17 ON 3 1 NA
6 ON 1 2 0 18 ON 3 2 NA
7 ON 1 3 B1 19 ON 3 3 NA
8 ON 1 3 B2 20 ON 3 4 NA
9 ON 1 3 0 21 ON 3 5 NA
10 ON 1 4 B1 22 ON 3 6 NA
11 ON 1 4 B2 23 ON 3 7 NA
12 ON 1 4 0 24 ON 3 8 NA
SAVE SETTINGS
06/05/2002 SYSTEM ID: PG-FlexPlus 13:54:33
    
```

CONFIG — Timeslot Configuration (Integrated) (Continued)

Step	Action
3	<p>The following actions can be taken:</p> <ol style="list-style-type: none"> To change the CU value, press SPACEBAR to toggle to the desired value, or press ← or → to move to next option. To change the CU# and CH# values, press SPACEBAR to toggle to the desired value, or press ↓, ↑, ← or → to move to next option. To enable or disable timeslots, press SPACEBAR to toggle to the desired value, or press ↓, ↑, ← or → to move to next option. To assign the SUB-CH# value, press SPACEBAR to toggle to the desired value, or press ↓, ↑, ← or → to move to next option. To save the Timeslot Configuration changes, select the SAVE SETTINGS button, then press ENTER. From the TIMESLOT CONFIGURATION WILL BE CHANGED. CONTINUE (Y/N)? prompt, the following actions can be taken: <ul style="list-style-type: none"> To save the Timeslot Configuration changes, press Y. The following events occur: <ul style="list-style-type: none"> – all current values are set to desired values
4	<p>Press ESC. The Main Menu screen reappears.</p>

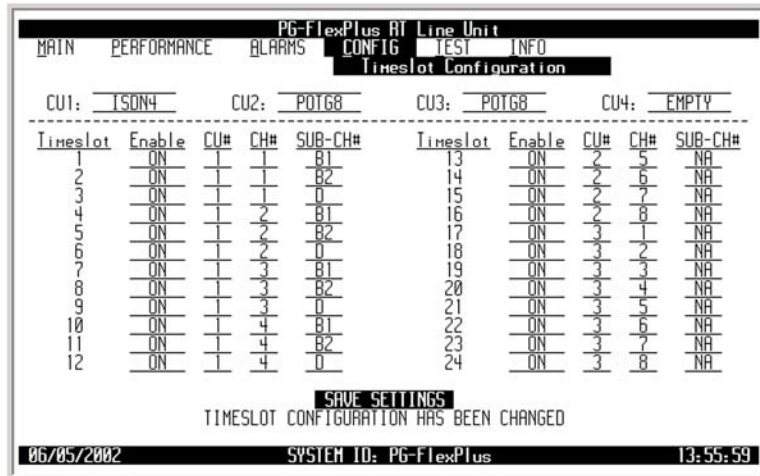
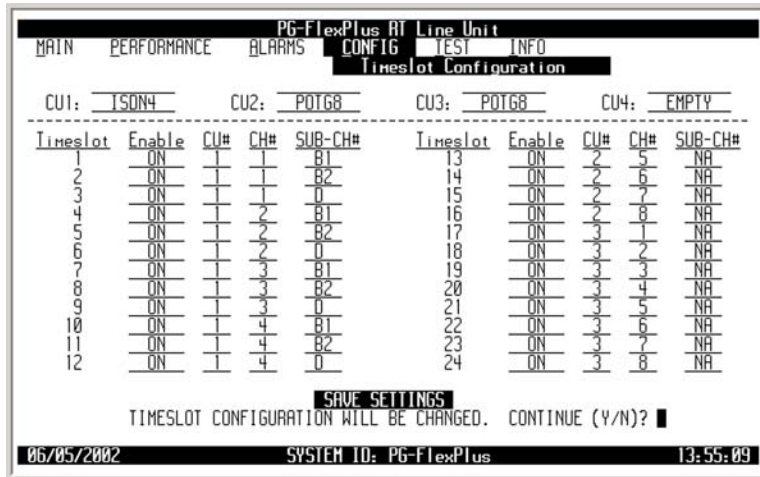



Table 26. Timeslot Configuration Options

System Options	Value	Description	Default
Enable	ON	Enable timeslot	ON
	OFF	Disable timeslot	
CU1, CU2, CU3, or CU 4	POTS8	8 channel unit for POTS loop-start	POTS8
	POTG8	8 channel unit for POTS loop-start and ground-start	POTS8
	ISDN4	4 channel unit for ISDN	POTS8
	EMPTY	Current not configured or timeslot is empty	EMPTY
CU #	1	Possible channel unit values – Channel unit #4 value is only supported by the FRE-765 series of RT enclosures	Timeslot 1-24 are mapped as: CU1, CH-1-8 CU2, CH-1-8 CU3, CH-1-8 with SUB-CH=NA sequentially
	2		
	3		
	4		
CH #	1 – 8	Possible values for POTS8 and POTG8	
	1 – 4	Possible values for ISDN4	
SUB-CH #	NA	Possible values for POTS8 and POTG8	
	B1, B2, D	Possible values for ISDN4	

CONFIG — Channel Configuration (Universal)

This screen allows each individual channel to be set as enabled or disabled (Universal setup). If any one card (COLU, RTLU, COCU or RTCU) is removed, replaced or reinserted, the channel configuration is automatically preserved.

CONFIG — Channel Configuration (Universal)

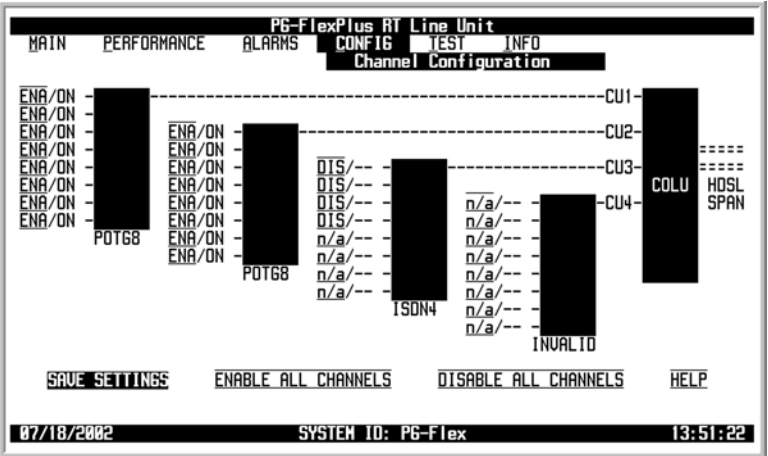
Step	Action
1	<p>At the Main Menu screen, select CONFIG. Press ↓ to choose Channel Configuration. The following screen appears.</p>  <p>The screenshot shows a terminal window titled "PG-FlexPlus RT Line Unit". At the top are menu options: MAIN, PERFORMANCE, ALARMS, CONFIG (highlighted), TEST, and INFO. A list of configuration options follows: System Options, COLU System Alarm Types, RTLU System Alarm Types, HDLS Alarm Thresholds, HDLS Alarm Types, ISDN Options, ISDN Alarm Thresholds, ISDN Alarm Types, Channel Unit Alarm Types, POTS Options, LS/GS Options, Set Factory Defaults, and Channel Configuration (highlighted). The status bar at the bottom reads "07/18/2002 SYSTEM ID: PG-Flex 13:50:48".</p>
2	<p>Press ENTER. The following screen appears.</p>  <p>The screenshot shows the "Channel Configuration" screen. At the top are menu options: MAIN, PERFORMANCE, ALARMS, CONFIG (highlighted), TEST, and INFO. Below is "Channel Configuration". The screen displays several channels with their status: POT68 (ENA/ON), POT68 (ENA/ON), ISDN4 (DIS/--), INUALTO (n/a/--), CU1 (ENA/ON), CU2 (ENA/ON), CU3 (DIS/--), CU4 (n/a/--), and COLU (DIS/--). The status bar at the bottom reads "07/18/2002 SYSTEM ID: PG-Flex 13:51:22".</p>

CONFIG — Channel Configuration (Universal) (Continued)

Step	Action
3	<p>The following actions can be taken:</p> <ol style="list-style-type: none"> To change a field value (enable or disable), press SPACEBAR to toggle to the desired value, or press ↓, ↑, ← or → to move to next option. To Enable All Channels, select the ENABLE ALL CHANNELS button, then press ENTER. To Disable All Channels, select the DISABLE ALL CHANNELS button, then press ENTER. To save the Channel Configuration changes, select the SAVE SETTINGS button, then press ENTER. From the CHANNEL CONFIGURATION WILL BE CHANGED. CONTINUE (Y/N)? prompt, the following actions can be taken: <ul style="list-style-type: none"> To save the Channel Configuration changes, press Y. The following events occur: <ul style="list-style-type: none"> all current values are set to desired values

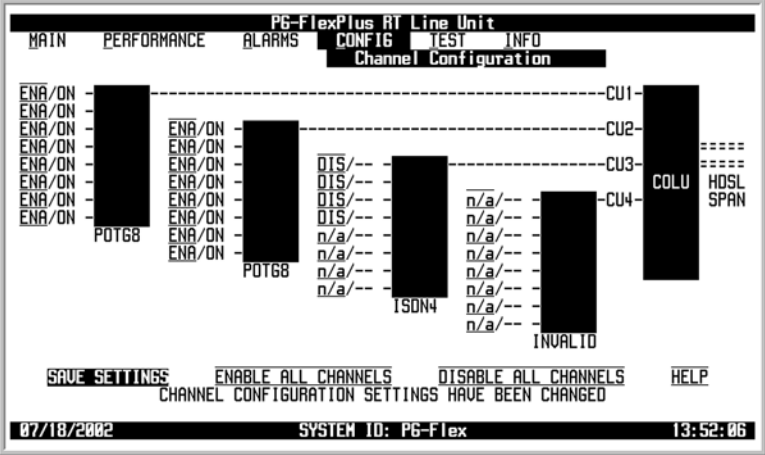
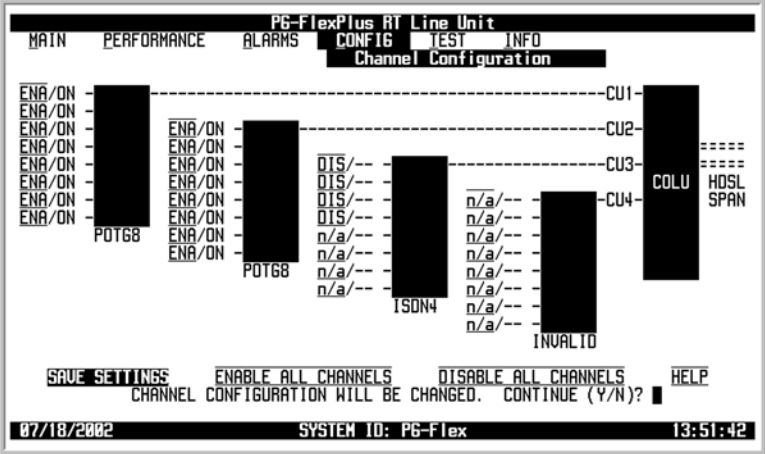

- To retain the existing configuration data, press **N**.

CONFIG — Channel Configuration (Universal) (Continued)

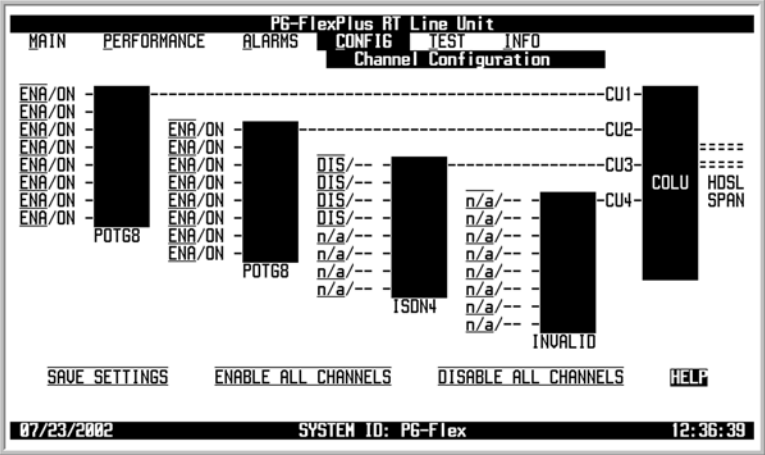
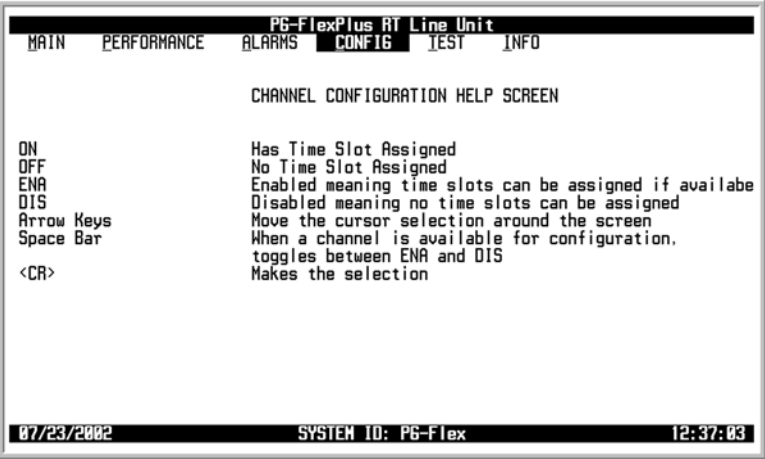
Step	Action
4	<p>To view the Help Screen, select the HELP button, then press ENTER. The Help screen appears.</p>  
5	<p>Press ESC. The Main Menu screen reappears.</p>

TEST MENU OPTIONS

The Test Menu provides access to the Subscriber Drop Test Facility. Refer to [Table 27](#) for sub-menu options and descriptions, parameters and valid values.



If you attempting to run a second test when one test is already in progress, a flashing warning message appears. Wait a few minutes, then try to run the test again.



Table 27. Test Menu Options



Sub-Menu Options	Sub-Menu Descriptions	Parameters	Valid Values
Subscriber Drop	Allows Subscriber Drop Test to be performed on a particular channel	<ul style="list-style-type: none"> • CU# • CH# • ISDN (CU#, CH#) Chosen for Test. **WARNING** Calls in Progress on Test Circuit will be Terminated. Continue with Test (Y/N)?: 	<ul style="list-style-type: none"> • 1 – 3 • 1 – 8 (POTS) • 1 – 4 (ISDN) • Y or N

TEST — Subscriber Drop Test

This screen allows a subscriber drop test to be performed on a particular channel.

CAUTION *Performing a subscriber drop test on any channel interrupts service on the line under test. The remaining lines on the system remain in service.*

TEST — Subscriber Drop Test

Step	Action												
1	<p>At the Main Menu screen, select TEST. Press ↓ to choose Subscriber Drop Test. The following screen appears.</p>  <p>The screenshot shows a terminal window with a menu at the top: MAIN PERFORMANCE ALARMS CONFIG TEST INFO. The 'TEST' option is selected and highlighted, and a sub-menu 'Subscriber Drop Test' is displayed below it. At the bottom of the screen, the date '06/05/2002', 'SYSTEM ID: PG-FlexPlus', and time '13:59:13' are visible.</p>												
2	<p>Press ENTER. The following screen appears.</p>  <p>The screenshot shows the 'Subscriber Drop Test' screen. It displays a table of channels:</p> <table border="1" data-bbox="690 1346 998 1430"> <thead> <tr> <th>CU#</th> <th>TYPE</th> <th>VALID CHANNELS</th> </tr> </thead> <tbody> <tr> <td>1</td> <td>INVALID</td> <td>[No valid channels]</td> </tr> <tr> <td>2</td> <td>POTGB</td> <td>[#1 through #8]</td> </tr> <tr> <td>3</td> <td>POTGB</td> <td>[#1 through #8]</td> </tr> </tbody> </table> <p>Below the table, it prompts: 'Select CU# and Channel# for Test:'. The user has entered '2' for CU# and '1' for CH#. The prompt 'Accept CU#/Channel# and start Test' is shown at the bottom. The date '06/05/2002', 'SYSTEM ID: PG-FlexPlus', and time '14:17:31' are visible at the bottom of the screen.</p>	CU#	TYPE	VALID CHANNELS	1	INVALID	[No valid channels]	2	POTGB	[#1 through #8]	3	POTGB	[#1 through #8]
CU#	TYPE	VALID CHANNELS											
1	INVALID	[No valid channels]											
2	POTGB	[#1 through #8]											
3	POTGB	[#1 through #8]											

TEST — Subscriber Drop Test (Continued)

Step	Action
3	<p>The following actions can be taken:</p> <ol style="list-style-type: none"> To assign the CU# value, select the CU# field, then press SPACEBAR to toggle to the desired value. To assign the CH# value, select the CH# field, then press SPACEBAR to toggle to the desired value. To accept the changes, select the Accept CU#/Channel# and Start Test button, then press ENTER. From the ISDN (CU#, CH#) CHOSEN FOR TEST. **WARNING** CALLS IN PROGRESS ON TEST CIRCUIT WILL BE TERMINATED. CONTINUE WITH TEST (Y/N)? prompt, the following actions can be taken: <ul style="list-style-type: none"> To start the test, press Y. <div style="border: 1px solid black; padding: 5px; margin: 10px 0;"> <pre> PG-FlxPlus RT Line Unit MAIN PERFORMANCE ALARMS CONFIG TEST INFO Subscriber Drop Test Subscriber Drop Test POTS (CU2, CH1) CHOSEN FOR TEST. ** WARNING ** CALLS IN PROGRESS ON TEST CIRCUIT WILL BE TERMINATED. CONTINUE WITH TEST (Y/N)? 06/05/2002 SYSTEM ID: PG-FlxPlus 14:18:13 </pre> </div> <div style="border: 1px solid black; padding: 5px; margin: 10px 0;"> <pre> PG-FlxPlus RT Line Unit MAIN PERFORMANCE ALARMS CONFIG TEST INFO Subscriber Drop Test Subscriber Drop Test ** POTS (CU2,CH1) TEST IN PROGRESS ** HIT 'S' TO STOP THE TEST 06/05/2002 SYSTEM ID: PG-FlxPlus 14:18:39 </pre> </div> <ol style="list-style-type: none"> To abort the test, press N. Then press ESC and the Main Menu reappears.

TEST — Subscriber Drop Test (Continued)

Step	Action
4	<p>Upon completion of all tests, the Subscriber Drop Test Results screen with the Subscriber Test, Failure Condition, and Test Status results is displayed. Tests are performed in the order of display.</p> <div data-bbox="477 428 1240 905" style="border: 1px solid black; padding: 5px; margin: 10px auto; width: fit-content;"> <pre> PG-FlexPlus RI Line Unit MAIN PERFORMANCE ALARMS CONFIG TEST INFO Subscriber Drop Test POTS (CU2, CH1) SUBSCRIBER DROP TEST RESULTS SUBSCRIBER TEST FAILURE CONDITION TEST STATUS ----- Hazardous Potential T-G or R-G > 50 Vrms PASSED T-G or R-G > 135 Vdc Foreign Voltage T-G or R-G AC volt. > 10 Vrms PASSED T-G or R-G DC volt. > 6 Vdc Resistive Fault T-G, R-G, or T-R resist. < 150 Kohms PASSED Receiver Off-Hook Phone is Off-Hook PASSED Ringers Test Ringer Load across T-R > 5 REN FAILED Ringer Load across T-R < 0.1 REN </pre> </div> <p> If a test fails, the remaining tests are not performed (as per TA-909). It takes approximately seven to eight seconds for all tests to complete.</p>
5	<p>Press ESC. The Main Menu screen reappears.</p>

INFORMATION MENU OPTIONS

The Information Menu provides technical information about the system. Refer to [Table 28](#) for sub-menu options and descriptions.



On the INFO Menu, COCU Inventory menu option appears between LU Inventory and RTCU Inventory options in an Universal setup. The Integrated setup is shown below.

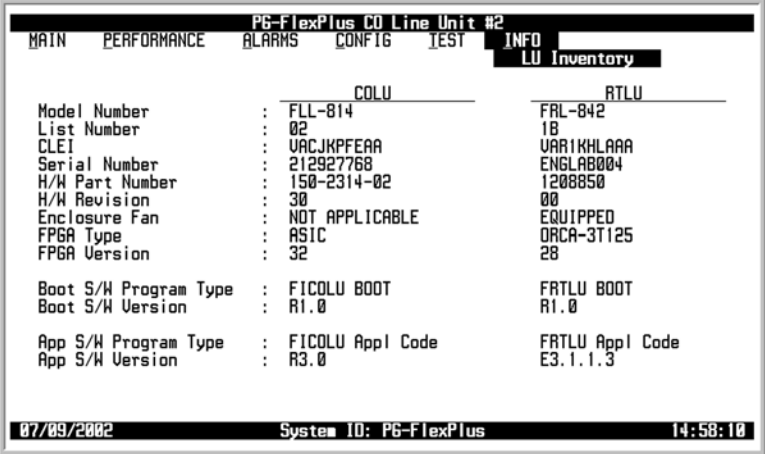

Table 28. Information Menu Options

Sub-Menu Options	Sub-Menu Descriptions
LU Inventory	Displays product identification information, manufacturing data, software and hardware revisions for COLU and RTLU
COCU Inventory (Universal setup)	Displays product identification information, manufacturing data, software and hardware revisions for CO Channel Units (CU1, CU2, CU3)
RTCU Inventory	Displays product identification information, manufacturing data, software and hardware revisions for RT Channel Units (CU1, CU2, CU3)
Doublers	Displays product identification information, manufacturing data, software and hardware revisions for Doublers (DB1, DB2)
Common Cards	Displays product identification information, manufacturing data, software and hardware revisions for Common Cards (Alarm)
Help	Provides information on using the system screens and menus

INFO — LU Inventory

This screen displays product identification information, manufacturing data, software and hardware revisions for COLU and RTLU.

Step	Action																																										
1	<p>At the Main Menu screen, select INFO. Press ↓ to choose LU Inventory. The following screen appears.</p>  <p>The screenshot shows a terminal window with a menu at the top: MAIN PERFORMANCE ALARMS CONFIG TEST INFO. The 'INFO' option is selected, and a sub-menu is displayed with 'LU Inventory' highlighted. Other options in the sub-menu are 'ATCU Inventory', 'Doublers', 'Common Cards', and 'Help'. The status bar at the bottom shows '06/05/2002', 'SYSTEM ID: PG-FlexPlus', and '14:19:33'.</p>																																										
2	<p>Press ENTER. The following screen appears.</p>  <p>The screenshot shows the 'LU Inventory' screen with two columns of data: COLU and RTLU. The status bar at the bottom shows '07/09/2002', 'System ID: PG-FlexPlus', and '14:58:10'.</p> <table border="1" data-bbox="511 1205 1206 1499"> <thead> <tr> <th></th> <th>COLU</th> <th>RTLU</th> </tr> </thead> <tbody> <tr> <td>Model Number</td> <td>FLL-814</td> <td>FRL-842</td> </tr> <tr> <td>List Number</td> <td>02</td> <td>18</td> </tr> <tr> <td>CLEI</td> <td>UACJKPFERR</td> <td>UARR1KHLAAA</td> </tr> <tr> <td>Serial Number</td> <td>212927768</td> <td>ENGLAB004</td> </tr> <tr> <td>H/W Part Number</td> <td>150-2314-02</td> <td>1208850</td> </tr> <tr> <td>H/W Revision</td> <td>30</td> <td>00</td> </tr> <tr> <td>Enclosure Fan</td> <td>NOT APPLICABLE</td> <td>EQUIPPED</td> </tr> <tr> <td>FPGA Type</td> <td>ASIC</td> <td>ORCA-3T125</td> </tr> <tr> <td>FPGA Version</td> <td>32</td> <td>28</td> </tr> <tr> <td>Boot S/W Program Type</td> <td>FICOLU BOOT</td> <td>FRTLU BOOT</td> </tr> <tr> <td>Boot S/W Version</td> <td>R1.0</td> <td>R1.0</td> </tr> <tr> <td>App S/W Program Type</td> <td>FICOLU Appl Code</td> <td>FRTLU Appl Code</td> </tr> <tr> <td>App S/W Version</td> <td>R3.0</td> <td>E3.1.1.3</td> </tr> </tbody> </table>		COLU	RTLU	Model Number	FLL-814	FRL-842	List Number	02	18	CLEI	UACJKPFERR	UARR1KHLAAA	Serial Number	212927768	ENGLAB004	H/W Part Number	150-2314-02	1208850	H/W Revision	30	00	Enclosure Fan	NOT APPLICABLE	EQUIPPED	FPGA Type	ASIC	ORCA-3T125	FPGA Version	32	28	Boot S/W Program Type	FICOLU BOOT	FRTLU BOOT	Boot S/W Version	R1.0	R1.0	App S/W Program Type	FICOLU Appl Code	FRTLU Appl Code	App S/W Version	R3.0	E3.1.1.3
	COLU	RTLU																																									
Model Number	FLL-814	FRL-842																																									
List Number	02	18																																									
CLEI	UACJKPFERR	UARR1KHLAAA																																									
Serial Number	212927768	ENGLAB004																																									
H/W Part Number	150-2314-02	1208850																																									
H/W Revision	30	00																																									
Enclosure Fan	NOT APPLICABLE	EQUIPPED																																									
FPGA Type	ASIC	ORCA-3T125																																									
FPGA Version	32	28																																									
Boot S/W Program Type	FICOLU BOOT	FRTLU BOOT																																									
Boot S/W Version	R1.0	R1.0																																									
App S/W Program Type	FICOLU Appl Code	FRTLU Appl Code																																									
App S/W Version	R3.0	E3.1.1.3																																									
3	<p>Press ESC. The Main Menu screen reappears.</p>																																										

INFO — COCU Inventory (Universal)

This screen displays product identification information, manufacturing data, software versions and hardware revisions for CO Channel Units (CU1, CU2, CU3) (Universal setup).

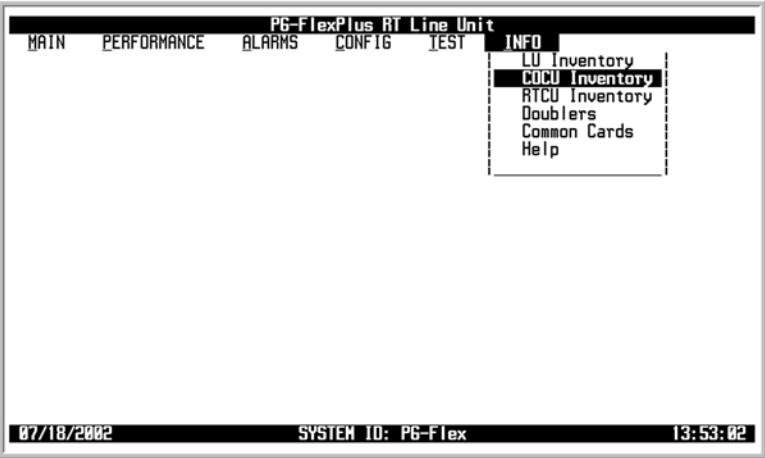
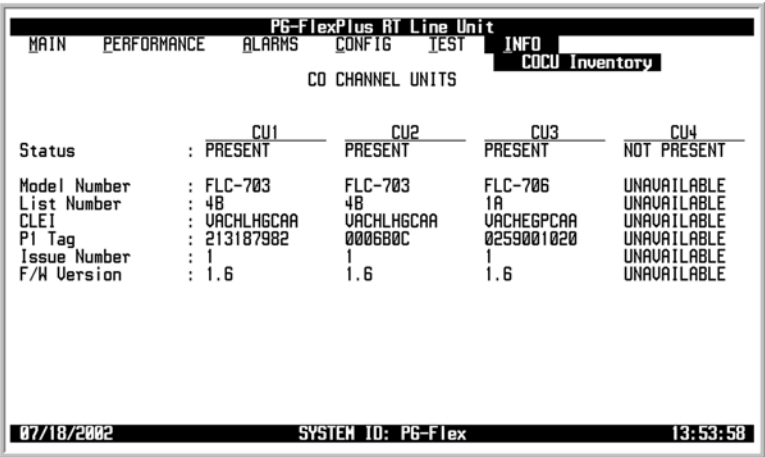
Step	Action
1	<p>At the Main Menu screen, select INFO. Press ↓ to choose COCU Inventory. The following screen appears.</p>  <p>The screenshot shows a terminal window with the title 'PG-FlexPlus RT Line Unit'. The menu options are: MAIN, PERFORMANCE, ALARMS, CONFIG, TEST, and INFO. The INFO option is selected, and a sub-menu is displayed with options: LU Inventory, COCU Inventory (highlighted), RTCU Inventory, Doublers, Common Cards, and Help. At the bottom, the date is 07/18/2002, the system ID is PG-Flex, and the time is 13:53:02.</p>
2	<p>Press ENTER. The following screen appears.</p>  <p>The screenshot shows the 'COCU Inventory' screen. The title is 'PG-FlexPlus RT Line Unit'. The menu options are: MAIN, PERFORMANCE, ALARMS, CONFIG, TEST, and INFO. The INFO option is selected, and the COCU Inventory screen is displayed. The screen shows the following information:</p> <pre> CO CHANNEL UNITS Status : CU1 CU2 CU3 CU4 : PRESENT PRESENT PRESENT NOT PRESENT Model Number : FLC-703 FLC-703 FLC-706 UNAVAILABLE List Number : 48 48 1A UNAVAILABLE CLEI : VACHLHGCAA VACHLHGCAA VACHEGPCAA UNAVAILABLE PI Tag : 213187902 0006B0C 0259001020 UNAVAILABLE Issue Number : 1 1 1 UNAVAILABLE F/H Version : 1.6 1.6 1.6 UNAVAILABLE </pre> <p>At the bottom, the date is 07/18/2002, the system ID is PG-Flex, and the time is 13:53:58.</p>
3	<p>Press ESC. The Main Menu screen reappears.</p>

INFO — RTCU Inventory

This screen displays product identification information, manufacturing data, software and hardware revisions for RT Channel Units (CU1, CU2, CU3, CU4).

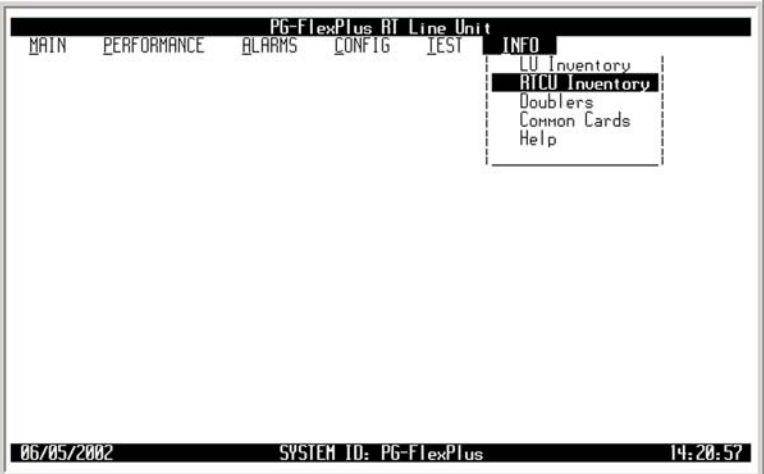
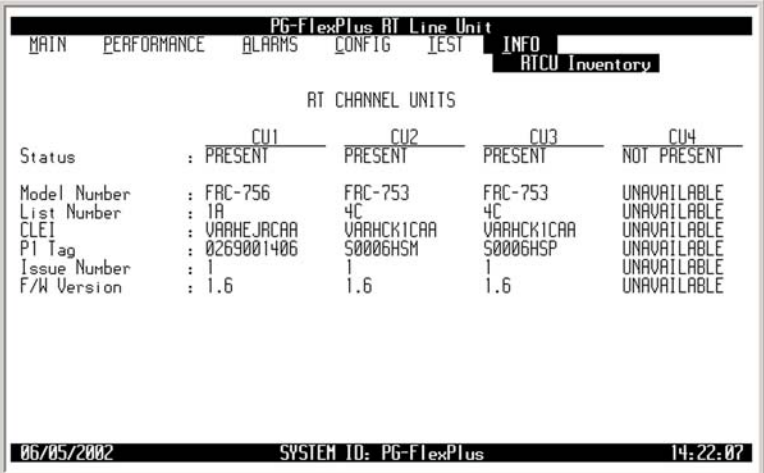
Step	Action																																								
1	<p>At the Main Menu screen, select INFO. Press ↓ to choose RTCU Inventory. The following screen appears.</p>  <p>The screenshot shows a terminal window with a menu at the top: MAIN PERFORMANCE ALARMS CONFIG TEST INFO. The INFO menu is expanded to show: LU Inventory, RTCU Inventory (highlighted), Doublers, Common Cards, and Help. At the bottom, it displays the date 06/05/2002, SYSTEM ID: PG-FlexPlus, and the time 14:20:57.</p>																																								
2	<p>Press ENTER. The following screen appears.</p>  <p>The screenshot shows the RTCU Inventory screen with the title 'RT CHANNEL UNITS'. It displays a table of information for four units: CU1, CU2, CU3, and CU4. The status for CU1, CU2, and CU3 is 'PRESENT', while for CU4 it is 'NOT PRESENT'. Other details include Model Number, List Number, CLEI, P1 Tag, Issue Number, and F/W Version.</p> <table border="1" data-bbox="495 1207 1218 1375"> <thead> <tr> <th></th> <th>CU1</th> <th>CU2</th> <th>CU3</th> <th>CU4</th> </tr> </thead> <tbody> <tr> <td>Status</td> <td>PRESENT</td> <td>PRESENT</td> <td>PRESENT</td> <td>NOT PRESENT</td> </tr> <tr> <td>Model Number</td> <td>FAC-756</td> <td>FAC-753</td> <td>FAC-753</td> <td>UNAVAILABLE</td> </tr> <tr> <td>List Number</td> <td>1A</td> <td>4C</td> <td>4C</td> <td>UNAVAILABLE</td> </tr> <tr> <td>CLEI</td> <td>VARHEJACAA</td> <td>VARHCK1CAA</td> <td>VARHCK1CAA</td> <td>UNAVAILABLE</td> </tr> <tr> <td>P1 Tag</td> <td>0269001406</td> <td>S0006HSM</td> <td>S0006HSP</td> <td>UNAVAILABLE</td> </tr> <tr> <td>Issue Number</td> <td>1</td> <td>1</td> <td>1</td> <td>UNAVAILABLE</td> </tr> <tr> <td>F/W Version</td> <td>1.6</td> <td>1.6</td> <td>1.6</td> <td>UNAVAILABLE</td> </tr> </tbody> </table> <p>The bottom of the screen shows the date 06/05/2002, SYSTEM ID: PG-FlexPlus, and the time 14:22:07.</p>		CU1	CU2	CU3	CU4	Status	PRESENT	PRESENT	PRESENT	NOT PRESENT	Model Number	FAC-756	FAC-753	FAC-753	UNAVAILABLE	List Number	1A	4C	4C	UNAVAILABLE	CLEI	VARHEJACAA	VARHCK1CAA	VARHCK1CAA	UNAVAILABLE	P1 Tag	0269001406	S0006HSM	S0006HSP	UNAVAILABLE	Issue Number	1	1	1	UNAVAILABLE	F/W Version	1.6	1.6	1.6	UNAVAILABLE
	CU1	CU2	CU3	CU4																																					
Status	PRESENT	PRESENT	PRESENT	NOT PRESENT																																					
Model Number	FAC-756	FAC-753	FAC-753	UNAVAILABLE																																					
List Number	1A	4C	4C	UNAVAILABLE																																					
CLEI	VARHEJACAA	VARHCK1CAA	VARHCK1CAA	UNAVAILABLE																																					
P1 Tag	0269001406	S0006HSM	S0006HSP	UNAVAILABLE																																					
Issue Number	1	1	1	UNAVAILABLE																																					
F/W Version	1.6	1.6	1.6	UNAVAILABLE																																					
3	<p>Press ESC. The Main Menu screen reappears.</p>																																								

INFO — Doublers

This screen displays product identification information, manufacturing data, software and hardware revisions for Doublers (DB1, DB2).

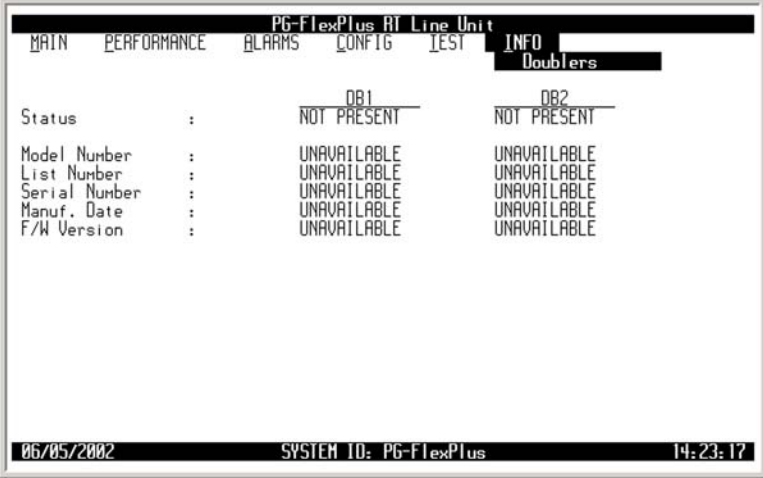
Step	Action
1	<p>At the Main Menu screen, select INFO. Press ↓ to choose Doublers. The following screen appears.</p>  <p>The screenshot shows a terminal window with a menu. At the top, it says 'PG-FlexPlus RT Line Unit'. Below that are several menu items: 'MAIN', 'PERFORMANCE', 'ALARMS', 'CONFIG', 'TEST', and 'INFO'. The 'INFO' menu is expanded, showing sub-items: 'LU Inventory', 'RTCU Inventory', 'Doublers' (which is highlighted with a black bar), 'Common Cards', and 'Help'. At the bottom of the terminal window, there is a status bar with the date '06/05/2002', 'SYSTEM ID: PG-FlexPlus', and the time '14:22:35'.</p>
2	<p>Press ENTER. The following screen appears.</p>  <p>The screenshot shows a terminal window displaying the 'Doublers' screen. At the top, it says 'PG-FlexPlus RT Line Unit'. Below that are menu items: 'MAIN', 'PERFORMANCE', 'ALARMS', 'CONFIG', 'TEST', 'INFO', and 'Doublers' (which is highlighted). The main content of the screen is a table with two columns for 'DB1' and 'DB2'. The rows are: 'Status', 'Model Number', 'List Number', 'Serial Number', 'Manuf. Date', and 'F/W Version'. The status for both DB1 and DB2 is 'NOT PRESENT'. All other fields are 'UNAVAILABLE'. At the bottom of the terminal window, there is a status bar with the date '06/05/2002', 'SYSTEM ID: PG-FlexPlus', and the time '14:23:17'.</p>
3	<p>Press ESC. The Main Menu screen reappears.</p>

INFO — Common Cards

This screen displays product identification information, manufacturing data, software and hardware revisions for Common Cards (PMU and PMX cards).

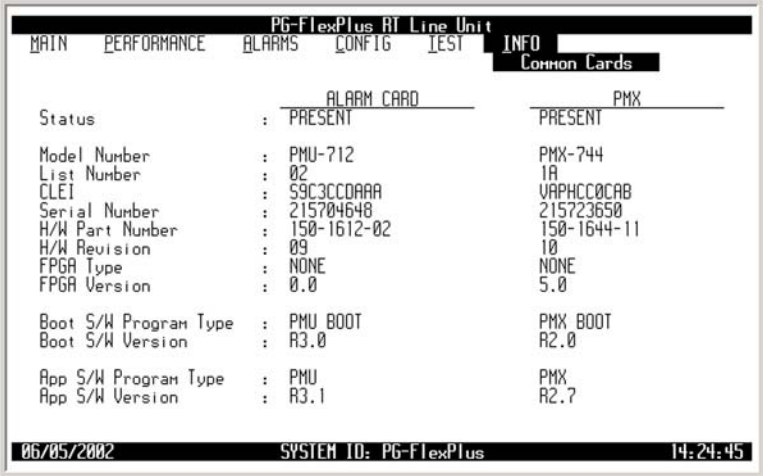
Step	Action																																										
1	<p>At the Main Menu screen, select INFO. Press ↓ to choose Common Cards. The following screen appears.</p>  <p>The screenshot shows a terminal window with a menu at the top: 'PG-FlexPlus RT Line Unit'. Below this are several menu items: 'MAIN', 'PERFORMANCE', 'ALARMS', 'CONFIG', 'TEST', and 'INFO'. The 'INFO' menu is expanded, showing sub-options: 'LU Inventory', 'RTCU Inventory', 'Doubblers', 'Common Cards' (which is highlighted), and 'Help'. At the bottom of the terminal, there is a status bar with the date '06/05/2002', 'SYSTEM ID: PG-FlexPlus', and the time '14:24:15'.</p>																																										
2	<p>Press ENTER. The following screen appears.</p>  <p>The screenshot shows a terminal window displaying the 'Common Cards' information. At the top, it says 'PG-FlexPlus RT Line Unit' and 'INFO Common Cards'. Below this, there are two columns of data: 'ALARM CARD' and 'PMX'. The data is as follows:</p> <table border="1"> <thead> <tr> <th></th> <th>ALARM CARD</th> <th>PMX</th> </tr> </thead> <tbody> <tr> <td>Status</td> <td>: PRESENT</td> <td>PRESENT</td> </tr> <tr> <td>Model Number</td> <td>: PMU-712</td> <td>PMX-744</td> </tr> <tr> <td>List Number</td> <td>: 02</td> <td>1A</td> </tr> <tr> <td>CLEI</td> <td>: S9C3CCDAAA</td> <td>VAPHC0CAB</td> </tr> <tr> <td>Serial Number</td> <td>: 215704648</td> <td>215723650</td> </tr> <tr> <td>H/W Part Number</td> <td>: 150-1612-02</td> <td>150-1644-11</td> </tr> <tr> <td>H/W Revision</td> <td>: 09</td> <td>10</td> </tr> <tr> <td>FPGA Type</td> <td>: NONE</td> <td>NONE</td> </tr> <tr> <td>FPGA Version</td> <td>: 0.0</td> <td>5.0</td> </tr> <tr> <td>Boot S/W Program Type</td> <td>: PMU BOOT</td> <td>PMX BOOT</td> </tr> <tr> <td>Boot S/W Version</td> <td>: R3.0</td> <td>R2.0</td> </tr> <tr> <td>App S/W Program Type</td> <td>: PMU</td> <td>PMX</td> </tr> <tr> <td>App S/W Version</td> <td>: R3.1</td> <td>R2.7</td> </tr> </tbody> </table> <p>At the bottom of the terminal, there is a status bar with the date '06/05/2002', 'SYSTEM ID: PG-FlexPlus', and the time '14:24:45'.</p>		ALARM CARD	PMX	Status	: PRESENT	PRESENT	Model Number	: PMU-712	PMX-744	List Number	: 02	1A	CLEI	: S9C3CCDAAA	VAPHC0CAB	Serial Number	: 215704648	215723650	H/W Part Number	: 150-1612-02	150-1644-11	H/W Revision	: 09	10	FPGA Type	: NONE	NONE	FPGA Version	: 0.0	5.0	Boot S/W Program Type	: PMU BOOT	PMX BOOT	Boot S/W Version	: R3.0	R2.0	App S/W Program Type	: PMU	PMX	App S/W Version	: R3.1	R2.7
	ALARM CARD	PMX																																									
Status	: PRESENT	PRESENT																																									
Model Number	: PMU-712	PMX-744																																									
List Number	: 02	1A																																									
CLEI	: S9C3CCDAAA	VAPHC0CAB																																									
Serial Number	: 215704648	215723650																																									
H/W Part Number	: 150-1612-02	150-1644-11																																									
H/W Revision	: 09	10																																									
FPGA Type	: NONE	NONE																																									
FPGA Version	: 0.0	5.0																																									
Boot S/W Program Type	: PMU BOOT	PMX BOOT																																									
Boot S/W Version	: R3.0	R2.0																																									
App S/W Program Type	: PMU	PMX																																									
App S/W Version	: R3.1	R2.7																																									
3	<p>Press ESC. The Main Menu screen reappears.</p>																																										

INFO — Help

This screen provides information on using the system screens and menus.

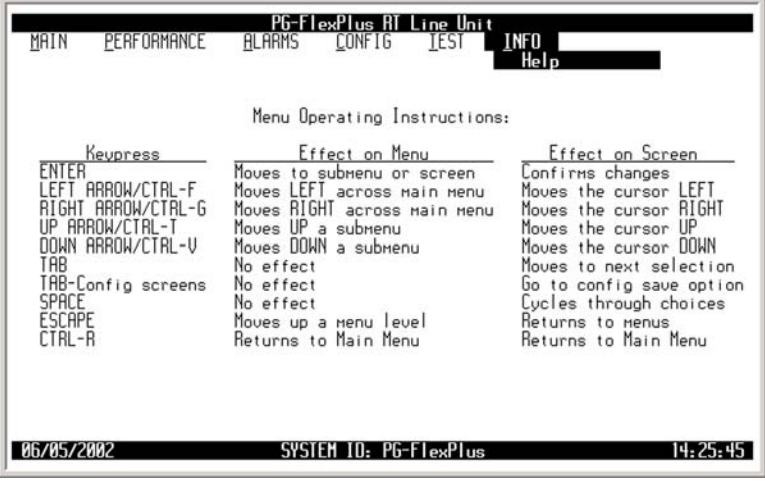
Step	Action
1	<p>At the Main Menu screen, select INFO. Press ↓ to choose Help. The following screen appears.</p> 
2	<p>Press ENTER. The following screen appears.</p> 
3	<p>Press ESC. The Main Menu screen reappears.</p>

FAULT ISOLATION AND TROUBLESHOOTING

Table 29 provides fault isolation and troubleshooting procedures for the FRL-842.

Table 29. COLU and RTLU Fault Isolation

Indicator	Probable Cause	Solution
PWR LED off	One or both HDSL lines are not connected between the COTS and FRTLU. Verify the connections at the FRTLU and COT Shelf.	Measure 130 Vdc to 260 Vdc between HDSL_T1 and HDSL_T2 on the RT Enclosure backplane
	COLU on-board fuse has blown	If power is present at COT Shelf backplane, replace the COLU If power is not present at COT Shelf backplane, replace the CO fuse
	FRTLU power supply has failed	Replace the FRTLU
	COLU power supply has failed	Replace the COLU
LOOP 1 (2) SYNC LED flashing or off	The HDSL line is attempting to synchronize with the CO unit or cannot detect the HDSL signal from the CO unit. This is usually an indication that there is a problem with the HDSL circuit between the COT and FRTLU (assuming the FAULT LED is off).	Verify the HDSL circuits are terminated correctly and with the correct orientation Measure the loop length of each HDSL circuit (shorting the pair at the far end). The loop length must be less than that shown in Table 1 on page 4 .
	COLU and FRTLU incompatible	Install compatible versions of the COLU and FRTLU
LOOP 1 (2) MARGIN LED on	The HDSL line margin level is below a preset level	See the previous discussion on the SYNC LED flashing or off
FAULT LED on	Faulty FRTLU	Replace the FRTLU

SUBSCRIBER REPORTED FAULTS

Table 30 provides fault isolation procedures for the system. Problems are listed in decreasing order of probability; the most likely action to resolve the problem is listed first. It is assumed that the system has successfully powered up, the HDSL circuits are synchronized end-to-end, there are no ES, UAS, or margin errors occurring, and no Fault LEDs are illuminated on the units installed in the COT shelf or RT enclosure.

Table 30. Subscriber Fault Isolating

Indicator	Probable Cause	Solution
All subscriber circuits cannot draw dial tone, telephones are not ringing, and ISDN circuits are not synchronizing	Incorrect provisioning of the PMX-744(s)	PMX-744 Verify the system options are set correctly
		COLU Verify the system options are set correctly
	Problem with the DS1 signals	DS1 Verify the presence and integrity of the DS1 signals terminated on the COT shelf
	Undetected hardware problem	Replace the following units with known good units in the following order: <ul style="list-style-type: none"> • FLL-812 • FLL-814 • FRL-842 • PMX-744(s) • RT channel units
One, or more, subscriber circuits cannot draw dial tone, telephones are not ringing and ISDN circuits are not synchronizing	Undetected hardware problem	Replace the following units with known good units in the following order: <ul style="list-style-type: none"> • RT channel unit on which the failures are occurring • FRL-842 • All RT channel units of the same type on which the failures are occurring



If system problems cannot be resolved after following the procedures in Table 30, contact Technical Support on page 139.

Appendix A

24 Channel Line Unit Feature Matrix

Feature	FLL-812	FLL-814				FRL-842 ⁽¹⁾			
	L1	L1	L1A	L1B	L2	L1	L1A	L1B	L2
<u>Power:</u>									
Line	●	●	●	●	●	●	●	●	
Local	●			●					●
<u>Alarms:</u>									
System	●	●	●	●	●	●	●	●	●
Environmental	●			●	●			●	●
Fan	●			●	●			●	●
<u>Subscriber Drop Testing:</u>									
TR-909	●	●	●	●	●	●	●	●	●
Bypass Pair	●					●	●	●	●
<u>Management:</u>									
TL1			●	●	●		●	●	●
<u>Switch Interface:</u>									
UDLC	●					●	●	●	●
IDLC		●	●	●	●	●	●	●	●
<u>Services:</u>									
POTS	●	●	●	●	●	●	●	●	●
ISDN	●	●	●	●	●	●	●	●	●
<u>Customer Defaults:</u>									
BellSouth					●				

Notes:

- Feature implemented

(1) Default configuration parameters for the RTLU are determined by the COLU.

Compatibility Matrix

Compatibility	FLL-812	FLL-814			
	L1	L1	L1A	L1B	L2
FRL-842 List 1		●			
FRL-842 List 1A	●		●	■	■
FRL-842 List 1B	●		◆	●	●
FRL-842 List 2	●			●	●

Notes:

- COLU and RTLU are fully compatible
- Fan alarm not enabled
- ◆ Fan alarm and environmental alarms not enabled

ACRONYMS

2B1Q – 2 Binary, 1 Quarternary; A line code in which each 2 bits of the binary data stream are combined into a single symbol of the quaternary line signal

A

AWG – American Wire Gauge

B

BE – Bit Error

C

CD – Carrier Defect

CEV – Controlled Environment Vault

CO – Central Office

COT – Central Office Terminal

CPE – Customer Premises Equipment

CU – Channel Unit

D

DCE – Data Carrier Equipment

DS0 – Digital Signal Level 0

DS1 – Digital Signal Level 1

DSL – Digital Subscriber Line

DSR – Data Set Ready

DTE – Data Terminal Equipment

DTR – Data Terminal Ready

E

EOC – Embedded Operations Channel

ES – Errored Seconds

ESD – Electrostatic Discharge

F

FCC – Federal Communications Commission

G

GND – Ground

H

HDSL – High-bit-rate Digital Subscriber Line

I

IDLC – Integrated Digital Loop Carrier

ISDN – Integrated Services Digital Network

L**LED** – Light Emitting Diode**LOS** – Loss of Signal**LS/GS** – Loop Start/Ground Start**LU** – Line Unit**M****MLT** – Mechanized Loop Testing**MU** – Management Unit**MUX** – Multiplexer**N****NEBS** – Network Equipment Building System**NT1** – Network Termination Type-1**P****PCM** – Pulse Code Modulation**PGTC** – Pair Gain Test Controller**PM** – Performance Monitoring**PBX** – Private Branch Exchange**POTS** – Plain Old Telephone Service**PPM** – Parts Per Million**R****RD** – Receive**REN** – Ringer Equivalence**RMA** – Return Material Authorization**RT** – Remote Terminal**S****SES** – Severely Errored Seconds**SYNC** – Synchronization**T****TBCU** – Test Bus Control Unit**TD** – Transmit**U****UAS** – Unavailable Seconds**Z****ZBS** – Zero Bit Substitution

PRODUCT SUPPORT

TECHNICAL SUPPORT

Technical Assistance is available 24 hours a day, 7 days a week by the contacting Customer Service Engineering group at:

Telephone: 800.366.3891
The 800 telephone support line is toll-free in the U.S. and Canada.

Email: wsd_support@adc.com

Knowledge Base: http://adc.com/Knowledge_Base/index.jsp

Web: www.adc.com

LIMITED WARRANTY

Product warranty is determined by your service agreement. Refer to the ADC Warranty/Software Handbook for additional information, or contact your sales representative or Customer Service for details.

RETURNS

To return equipment to ADC:

1. Locate the number of the purchase order under which the equipment was purchased. To obtain a return authorization number, you need to provide the original purchase order number to ADC's Return Material Authorization (RMA) Department.
2. Call or write ADC's RMA Department to ask for an RMA number and any additional instructions. Use the telephone number, fax number or email address listed below:
 - Telephone: 800.366.3891
 - Email Address: rma@ADC.com
3. Include the following information, in writing, along with the equipment you are returning:
 - Company name and address
 - Contact name and telephone number
 - Shipping address to which ADC should return the repaired equipment
 - Original purchase order number
 - Description of the equipment that includes the model and part number of each unit being returned, as well as the number of units that you are returning.
 - Reason for the return. For example:
 - The equipment needs an ECO/ECN upgrade.
 - The equipment is defective.



If the equipment is defective, please tell us what you observed just before the equipment malfunctioned. Be as detailed in your description as possible.

If there is any other reason for returning the equipment, please let us know so we can determine how best to help you.

4. Pack the equipment in a shipping carton.

5. Write ADC's address and the RMA Number you received from the RMA Department clearly on the outside of the carton and return to:

ADC DSL Systems, Inc.
14352 Franklin Ave.
Tustin, CA 92780-7013
Attention: **RMA (Number)**



All shipments are to be returned prepaid. ADC will not accept any collect shipments.

FCC CLASS B COMPLIANCE

This equipment has been tested and found to comply with the limits for a Class B digital device, pursuant to part 15 of the FCC Rules. These limits are designed to provide reasonable protection against harmful interference in a residential installation. This equipment generates, uses and can radiate radio frequency energy and, if not installed and used in accordance with the instructions, may cause harmful interference to radio communications. However, there is no guarantee that interference will not occur in a particular installation. If this equipment does cause harmful interference to radio or television reception, which can be determined by turning the equipment off and on, the user is encouraged to try to correct the interference by one or more of the following measures:

- * Reorient or relocate the receiving antenna.
- * Increase the separation between the equipment and receiver.
- * Connect the equipment into an outlet on a circuit different from that to which the receiver is connected.
- * Consult the dealer or an experienced radio/TV technician for help.

MODIFICATIONS

The FCC requires the user to be notified that any changes or modifications made to this device that are not expressly approved by ADC voids the user's warranty.

All wiring external to the product(s) should follow the provisions of the current edition of the National Electrical Code.

World Headquarters:

ADC Telecommunications, Inc.
12501 Whitewater Drive
Minnetonka, Minnesota USA 55343

For Technical Assistance:

800.366.3891



1226551
